

# Deviations and errors review on measuring and calculating heavy fuel oil consumption and fuel stock onboard vessels equipped with volumetric fuel consumption flowmeters

---

Dujmović, Josip; Bernečić, Dean

Source / Izvornik: **Pomorstvo, 2021, 35, 297 - 307**

Journal article, Published version

Rad u časopisu, Objavljena verzija rada (izdavačev PDF)

<https://doi.org/10.31217/p.35.2.12>

Permanent link / Trajna poveznica: <https://urn.nsk.hr/urn:nbn:hr:187:516679>

Rights / Prava: [In copyright](#)/[Zaštićeno autorskim pravom.](#)

Download date / Datum preuzimanja: **2024-08-05**



**Sveučilište u Rijeci, Pomorski fakultet**  
University of Rijeka, Faculty of Maritime Studies

Repository / Repozitorij:

[Repository of the University of Rijeka, Faculty of  
Maritime Studies - FMSRI Repository](#)



Multidisciplinary  
SCIENTIFIC JOURNAL  
OF MARITIME RESEARCH



University of Rijeka  
FACULTY OF MARITIME STUDIES

Multidisciplinarni  
znanstveni časopis  
POMORSTVO

<https://doi.org/10.31217/p.35.2.12>

# Deviations and errors review on measuring and calculating heavy fuel oil consumption and fuel stock onboard vessels equipped with volumetric fuel consumption flowmeters

Josip Dujmović, Dean Bernečić

University of Rijeka, Faculty of Maritime Studies, Studentska 2, 51000 Rijeka, Croatia, e-mail: [josip.dujmovic@pfri.uniri.hr](mailto:josip.dujmovic@pfri.uniri.hr); [dean.berniecic@pfri.uniri.hr](mailto:dean.berniecic@pfri.uniri.hr)

## ABSTRACT

A common way of measuring heavy fuel oil consumption on board a vessel is to use volumetric fuel flow meters installed at fuel systems inlets for each of the major fuel consumers. At each stage of the fuel processing cycle, certain mass fuel losses or deviations and calculation errors occur that are not counted accurately into fuel consumption figures. The goal of this paper is to identify those fuel mass losses and measuring/calculating errors and perform their quantitative numerical analysis based on actual data. Fuel mass losses defined as deviations identified during the fuel preparation process are evaporation of volatile organic compounds, water drainage, fuel separation, and leakages while errors identified are flow meter accuracy and volumetric/mass flow conversion accuracy. By utilizing statistical analysis of obtained data from engine logbook extracts from three different ships numerical models were generated for each fuel mass loss point. Measuring errors and volumetric/mass conversion errors are numerically analyzed based on actual equipment and models used onboard example vessels. By computational analysis of the obtained models, approximate percentage losses and errors are presented as a fraction of fuel quantity on board or as a fraction of fuel consumed. Those losses and errors present between 0,001% and 5% of fuel stock or fuel consumption figures for each identified loss/error point. This paper presents a contribution for more accurate heavy fuel oil consumption calculation and consequently accurate declaration of remaining fuel stock onboard. It also presents a base for possible further research on the possible influence of fuel grade, fuel water content on the accuracy of consumption calculation.

## ARTICLE INFO

Preliminary communication  
Received 23 June 2021  
Accepted 11 November 2021

### Key words:

Ship  
Fuel consumption  
Heavy fuel oil  
Errors  
Deviations  
Fuel mass loss  
Volumetric/mass flow conversion  
Remaining onboard stock

## 1 Introduction

Accurate measurement and monitoring of heavy fuel oil consumption on board are crucial for a variety of reasons; accurate reporting of fuel consumption, monitoring of the vessel's technical condition, accurate reporting of fuel quantity to customs and port authorities, accurate reporting of exhaust gas emissions. One of the common ways how to measure fuel oil consumption on board is to use volumetric fuel flow meters installed at the fuel inlet to self-contained fuel systems for each major fuel consumer.

Heavy fuel oil onboard is prepared in a process that consists of bunkering fuel, storage, settling, separation, heating, and filtration. Only after passing through each of the phases fuel is introduced into consumption.

During the storage and settling phase, heavy fuel oil undergoes a heating phase in settling tanks where settling of heavy components and free water occurs. Following the settling phase, centrifugal purification takes place followed by final filtration and heating to the required temperature to achieve predefined viscosity. During each of these phases, certain mass losses of the fuel occur which will be defined as deviations in further text. At the introduction in consumption, fuel is passing through volumetric flow meter where errors might occur due to flow meter inaccuracy and volume/mass flow conversion. These deviations and errors in heavy fuel oil consumption consequently cause the remaining heavy fuel oil quantity onboard might be wrongly calculated.

Authors are not aware of similar papers or research done in this field. Issues of calculating fuel consump-



Fig. 1 Basic concept of measuring fuel oil consumption utilizing volumetric flowmeters

Source: Authors

tion for emission monitoring are described in the paper Faber, J., et al. (2013) [8]. Losses of evaporation of petroleum products are mentioned in Hu, G. et al. (2020) [10]. Dependence of evaporation on fuel oil temperature in the tank for light petroleum products is described in Levitin, R.E., Tryascin, RA (2016) [13].

The goal of this paper is to identify those discrepancies and to perform their quantitative numerical analysis based on actual data obtained from actual vessels.

## 2 Fuel consumption measuring concept and discrepancies identification

### 2.1 Fuel oil consumption measuring concept by using volumetric fuel consumption flowmeters

The basic concept of measuring fuel consumption onboard during a certain period consists of subtracting consumed fuel quantity from delivered quantity, as presented in Fig. 1. This would consequently declare heavy fuel quantity stock (ROB – remaining onboard) as per formula (1).

$$Fuel_{ST} = BDN - Fuel_{CONSMT} \tag{1}$$

where is:

- $Fuel_{ST}$  – Heavy fuel quantity stock onboard – ROB [mt],
- $BDN$  – Loaded heavy fuel oil through bunkering [mt],
- $Fuel_{CONSMT}$  – Consumed heavy fuel oil in mass units [mt].

Fuel consumption obtained by measuring with volumetric flow meters during the period  $\Delta t = t_2 - t_1$  is:

$$Fuel_{CONSM3} = \sum_{i=1}^n (Flow_{t2} - Flow_{t1}) \tag{2}$$

where is:

- $Fuel_{CONSM3}$  – Total consumed heavy fuel oil in volume units [ $m^3$ ],
- $Flow_{t2}$  – Cumulative state of the volumetric fuel flow meter at time  $t_2$  in volume units [ $m^3$ ],
- $Flow_{t1}$  – Cumulative state of the volumetric fuel flow meter at time  $t_1$  in volume units [ $m^3$ ],
- $i$  – Number of volumetric flow meters installed onboard for different consumers.

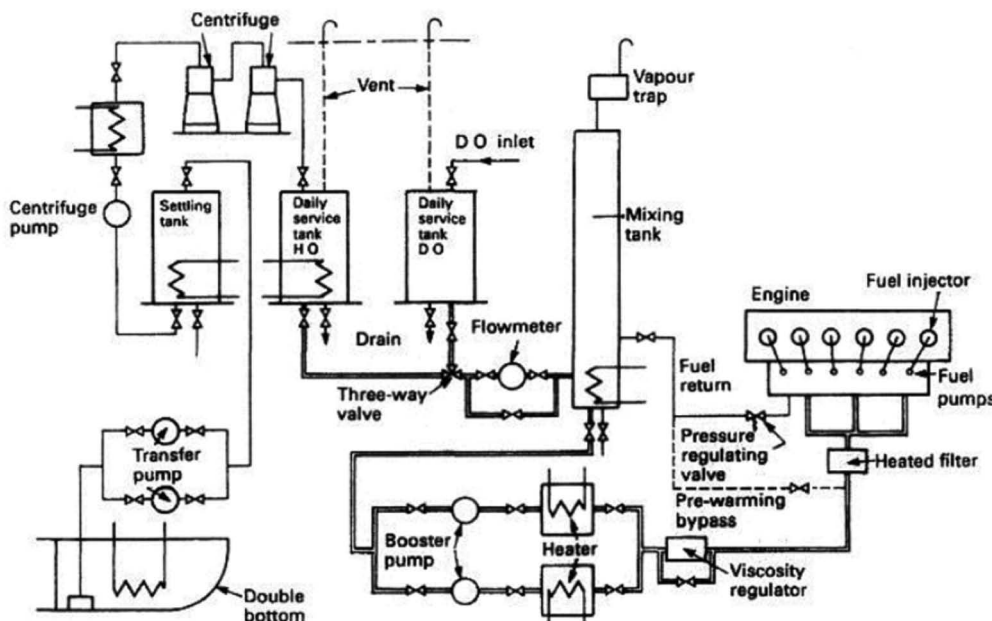

Fig. 2 Generic fuel system layout onboard a vessel

Source: www.machineryspaces.com

In case of temperature correction is not considered volume/mass flow conversion would be calculated:

$$Fuel_{CONSMT} = Fuel_{CONSM3} * Dens_{15} \tag{3}$$

where is:

$Dens_{15}$  – Declared heavy fuel oil density at 15 °C [mt/m³].

### 2.2 Discrepancies identification in fuel consumption measuring onboard a vessel equipped with volumetric fuel flowmeters

Loading fuel into the storage tanks is the first step of the fuel preparation process where fuel is heated to a temperature 10 °C above the pour point [15]. The fuel is then transferred to settling tanks where it is heated to a maximum temperature of 75 °C [15]. The accumulated water is there periodically drained by manual draining. Centrifugal purifier supply pumps suck in heavy fuel from settling tanks and supply it to centrifugal purifiers where fuel is purified. Purification of heavy fuel consists of removing water and heavy components from fuel utilizing introducing them into a purifier bowl subjected to a high centrifugal field. The temperature at which purification took place is 95-98 °C [15]. Purified fuel is delivered to the service tank where the mean temperature is kept around 80-85 °C. From the service tanks, the supply pumps suck in fuel and pump it through a volumetric flow meter into a closed fuel circulation system for final filtration, heating, and consumption; Fig. 2.

Through the described process, as presented in Fig. 3, shows that bunkered fuel quantity is subjected to the following discrepancies which are grouped in two groups: mass losses (or deviations) and measurements errors (or errors):

Mass fuel losses (deviations):

- Evaporation of volatile hydrocarbons during heating in storage, settling and service tanks,
- Drainage of water from settling and service fuel tanks,
- Separation of heavy residues and water in the fuel purifier,
- Leaks.

Consumption measurement errors (errors):

- Accuracy of volumetric flow meter,
- Accuracy of volumetric flow to mass flow conversion.

### 3 Research methodology and data sources

Previous research on heavy fuel volatile hydrocarbons evaporation is the base for mass losses from fuel evaporation. Mass losses caused by water drainage and fuel purification are based on a statistical analysis of limited available data obtained from engine logbook extracts from three different ships. Results of these statistical analyses are regression formulas that are generated based on obtained data from ships. Measuring errors of volumetric flow meters are based on actual flow meter technical details onboard a sample ship.

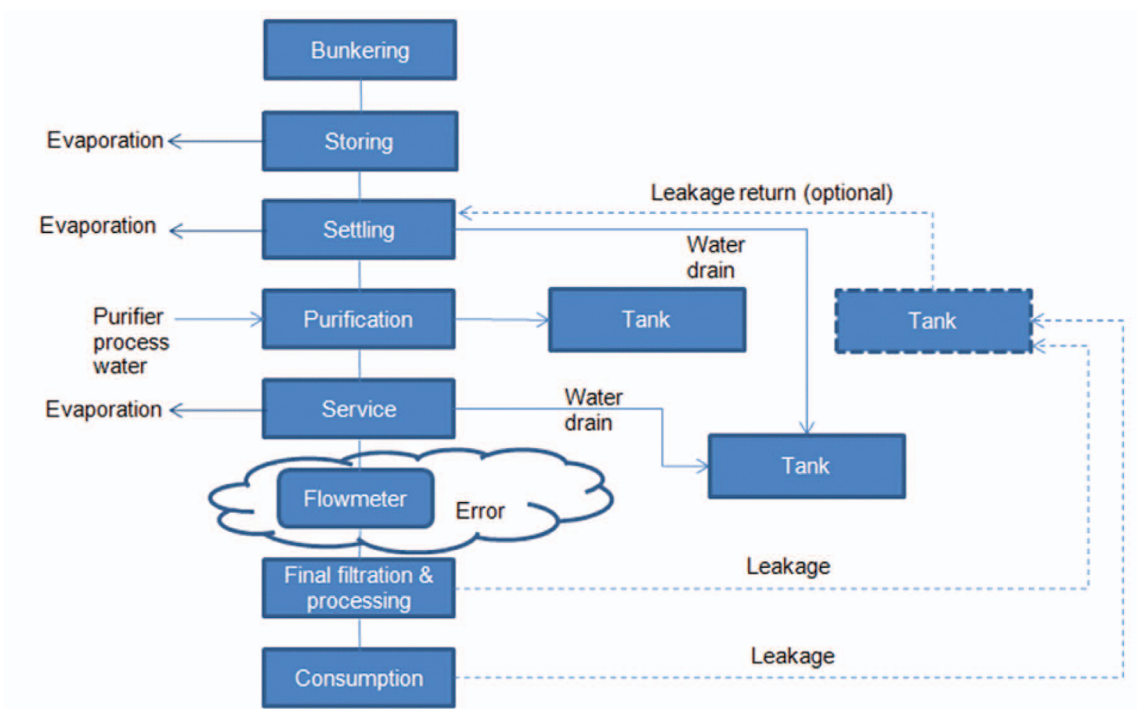

Fig. 3 Fuel system flow diagram with marked deviations and errors

Due to confidentiality and ship owner's data protection policies detailed ships data cannot be fully disclosed, so therefore observed vessels are presented as ship A, ship B, and ship C.

Ship A is a cellular container vessel with a capacity of 3534 TEU, 41000 DWT, and equipped with the main engine MAN B&W 7K90MC-C with MCR 31990 kW. Besides the main engine, four auxiliary diesel generators are installed driven by Hyundai Himsen 7H21/32 engines with an MCR of 1400 kW. Engine logbook extract and data from this vessel are taken during period 04/2008. Bunker delivery notes are based on the period 10/2008-01/2009.

Ship B is a crude oil tanker 49999 DWT and 29991 GT. It is equipped with a main propulsion engine MAN B&W 6G50ME-C9.5 and three auxiliary engines Hyundai Himsen 6H21/32 with MCR 960 kW each. Engine logbook extract and data from this vessel are taken during the period 02/2020-10/2020.

Ship C is a chemical tanker 27250 GT, 37874 DWT. She is powered by a two-stroke diesel engine MAN B&W 6S50ME-C9.6 with MCR 6502 kW. In addition, there are three generators installed driven by diesel engine Yanmar6EY22ALW with MCR 1020 kW each. Engine logbook extract and data from this vessel are taken during period 02/2021.

Data sources from three different ships were used due to following reasons:

- possibility to compare obtained results especially during different vessel operations regimes.
- data availability as not all required data was possible to be obtained from a single source (vessel).

## 4 Deviations and errors evaluation

### 4.1 Volatile organic compounds evaporation from heavy fuel subjected to heating in tanks

Volatile hydrocarbons evaporation (VOC – Volatile Organic Compounds) from fuel represents the fuel mass loss. According to research by Hu, G., et al. [10] the mass loss of VOC for crude oil depends on the temperature and gas-phase overpressure above the surface in the tank (in this case is ignored as the is not maintained in the tanks). VOC losses amount 10 mg/L/day for a stable temperature of 25-28 °C. Therefore, in ships conditions rough estimation is VOC evaporation loss during heating in tanks is 0.001%-0,0015% of the fuel weight per day of heating tanks. In shipboard conditions, any measurement of VOC evaporation in tanks could not be measured by daily sounding or any other means. The reason is relatively small mass loss, inaccurate measurement of tanks during movement, rolling, and instability of the ship. Therefore, the approximate formula for VOC evaporation losses during heating in tanks would be:

$$F_{loos} = \left( \frac{M_{serv} * 0,0001}{24} + \frac{M_{sett} * 0,0001}{24} + \sum_{i=1}^n \frac{M_{stor} * 0,0001}{24} \right) * \Delta t \quad (4)$$

where is:

$F_{loos}$  – Mass loss of fuel by VOC evaporation in the period  $\Delta t$ ,

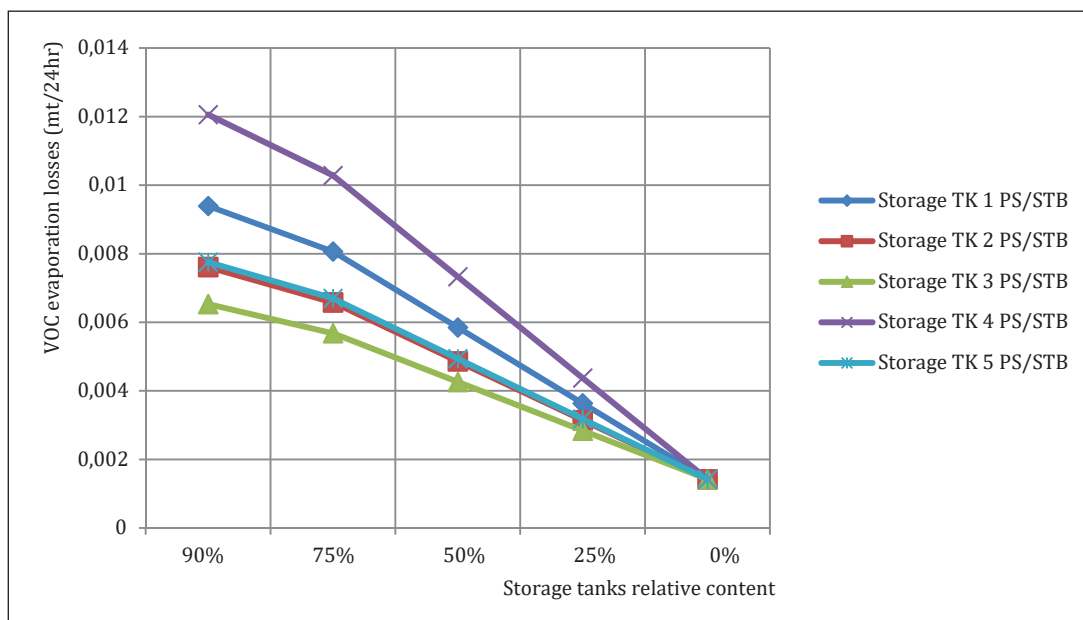

**Fig. 4** Total daily VOC evaporation losses as an example onboard ship A taking in consideration heating two symmetrical storage tanks and one settling/service tank

*Masserv* – Average quantity of fuel in the service tank during period  $\Delta t$ ,

*Masett* – Average quantity of fuel in the settling tank during period  $\Delta t$ ,

*Mastor* – Average quantity of fuel in the storage tank during period  $\Delta t$ ,

*i* – Number for heated heavy fuel oil storage tanks during period  $\Delta t$ .

**Table 1** Heavy fuel oil tanks capacities onboard ship A

| Tank         | Capacity (m <sup>3</sup> ) |
|--------------|----------------------------|
| HFO Service  | 2 × 85,6                   |
| HFO Settling | 2 × 75                     |
| 1 PS/STB     | 2 × 443                    |
| 2 PS/STB     | 2 × 344                    |
| 3 PS/STB     | 2 × 284                    |
| 4 PS/STB     | 2 × 591                    |
| 5 PS/STB     | 2 × 352                    |

Source: Engine logbook extract for ship A, [4]

As during consumption, the level of fuel varies in the settling tank and storage tanks the average quantity in the tanks during the period  $\Delta t$  is considered. The operational procedure for heavy fuel consumption from storage tanks is frequently such that the fuel is transferred symmetrically from two parallel storage tanks due to vessel stability reasons. In Fig. 4. VOC evaporation losses are presented based on calculation for tank contents onboard case ship A. Total evaporation losses, in this case, present losses in the case of heating two symmetrical parallel storage tanks for each line which also includes losses from settling and

service tank. In this case, only the storage tanks from which the fuel is consumed are heated.

#### 4.2 Free water drainage from settling and service tanks

Free water is usually present in heavy fuel in some percentage. Maximum allowable water content for heavy fuel oil grades according to ISO 8217-2017 (RMA 10 to RMK 700) fuel is 0.3% v/v for RMA 10 and 0.5% v/v for each subsequent gradation. Actual amount of free water in heavy fuel oil is measured by laboratory test according to ISO-3733 and is presented during bunkering as information in delivery note (BDN – Bunker Delivery Note). Water content can be obtained from a fuel sample by independent laboratory test as well. In addition to the free water contained in the fuel, the source of water in fuel can originate due to leaky heating steam coils in the tanks or by improper operation of the centrifugal purifier.

Free water is removed from fuel by manual draining from the settling and service tank and by centrifugal separation in purifiers. Drained water can be manually measured with appropriate gauges or by the daily sounding of a tank in which drained water is collected. Daily sounding might be inaccurate due to the inability to accurately measure small level increments or the inability to identify drained water from other sources if there are multiple sources of fluid that enter into the monitored collecting tank.

Onboard ship C, the free water drained from the fuel settling tank was observed during 14 days and averaged 12.7 liters/day; Fig. 5. The amount of free water in the fuel according to the BDN was 0.05% v/v. During the observed period, free water was not drained from the heavy fuel oil service tanks, as was not recorded in the logbook. During the monitored period amount of free water drained from

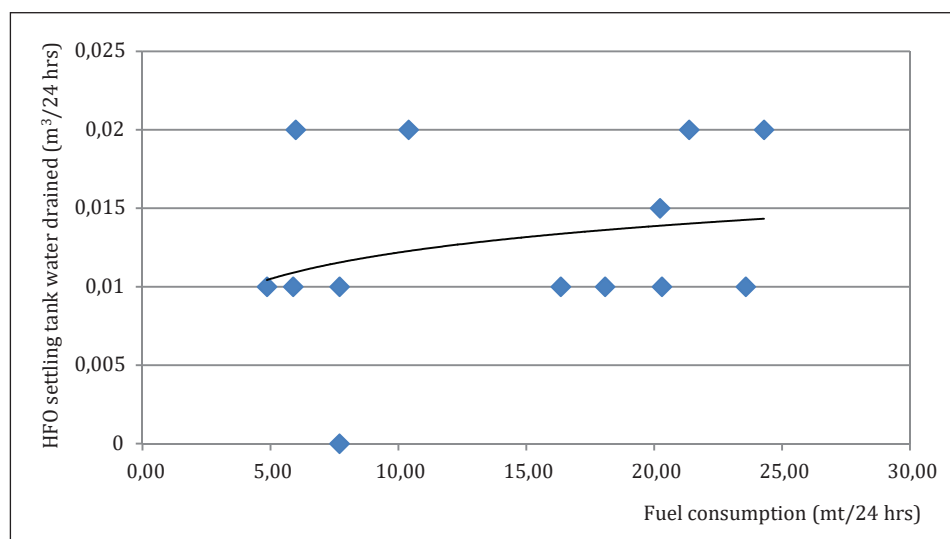

**Fig. 5** Drained water from settling tanks based as function of fuel consumption – ship C

Source: Authors based on engine logbook extract for ship C, [6]

**Table 2** Declared free water content as per BDN – ship A

| Bunkered heavy fuel |                     |            |                     |                   |
|---------------------|---------------------|------------|---------------------|-------------------|
| Date                | Fuel grad. ISO 8217 | Quantity   | Water content % V/V | Port of bunkering |
| 21-10-2008          | RMG 35              | 1667,36 MT | 0,05%               | Singapore         |
| 21-10-2008          | RMG 35              | 512,88 MT  | 0,05%               | Singapore         |
| 25-11-2008          | RMG 35              | 1195,01 MT | 0,20%               | Singapore         |
| 23-12-2008          | RMG 35              | 1226,8 MT  | 0,35%               | Singapore         |
| 08-01-2009          | RMG 35              | 490,6 MT   | 0,10%               | Singapore         |
| 25-01-2009          | RMG 35              | 1900,3 MT  | 0,20%               | San Pedro         |

Source: Bunker delivery notes for ship A for period 10/2008 – 01/2009, [3]

the settling tank in relation to consumption can be described with formula (5).

$$Wtr_{DRAIN} = 0,002 * \ln(Fuel_{CONSMT}) + 0,006 \quad (5)$$

### 4.3 Purification of heavy components and water in the fuel purifier

Centrifugal purifier removes undissolved heavy elements; Fig. 6, so-called abrasive particles, cat fines, and water from the fuel. The purification efficiency depends on the elements being removed from the fuel, fuel flow through the purifier bowl, and the separation temperature.

The quantity of components removed from heavy fuel largely depends on the fuel quality, content of asphalt components, and free water. Besides this additional quantity might be removed by separation due to processes that occur in the fuel such as residual aging, polymerization, fuel instability. According to International Maritime Organization guidelines, the amount of fuel and used process water during separation is 1% volume of main engine fuel consumption, as per IMO (2016) [12]. Accurate quantitative measurement of separated components under operating conditions is difficult to perform and is done by measuring the volume of liquid in the separator sludge

collecting tank. Such measurements will not present the exact quantity of components removed from fuel due to:

- Mixing of centrifugal purifier process water and removed fuel components in separator sludge collecting tank,
- Impossibility to identify the separated contents and water from centrifugal fuel purifier if there are other sources of liquid entering separator sludge collecting tank.

Process water consumption for the operation of the centrifugal separator during stable operation can be calculated according to:

$$Prowtr_{\Delta t} = \frac{Makeup}{\Delta t} + \sum_{i=0}^n Wtr_{Cycle} \quad (6)$$

that is:

$$Makeup = Makeup_{FLOW} * Makeup_{TIME} * Makeup_{INTER} \quad (7)$$

and:

$$Wtr_{Cycle} = Displwtr_{FLOW} * Displper_{TIME} + Openwtr_{FLOW} * Openper_{TIME} + Closewtr_{FLOW} * Closeper_{TIME} + Bowlfillwtr_{FLOW} * Bowlfillper_{TIME} \quad (8)$$

**Table 3** Efficiency of centrifugal separation

| Element in fuel    | Concentration reduction |
|--------------------|-------------------------|
| Na+K               | 80-99%                  |
| Ca                 | 20-80%                  |
| Mg                 | 40-60%                  |
| Water              | 80-90%                  |
| Ash                | 10-50%                  |
| Abrasive particles | 70-99%                  |

Source: Alfa Laval, Fuel oil treatment, [1]

**Fig. 6** Accumulations of asphalt components in the purifier bowl

Source: Josip Dujmović©, 2005

where is:

$Prowtr_{\Delta t}$  – Consumption of process water during period  $\Delta t$ ,

$i$  – Number of flushing cycles during period  $\Delta t$ ,

$Makeup$  – Consumption of process water for maintaining separation process,

$Wtr_{Cycle}$  – Consumption of process water for single flushing process.

$Displwtr_{FLOW}$  – Water flow for displacement during flushing cycle,

$Displper_{TIME}$  – Flow time for displacement water flow during flushing cycle,

$Openwtr_{FLOW}$  – Water flow for bowl opening during flushing cycle,

$Openper_{TIME}$  – Flow time for bowl opening during flushing cycle,

$Closewtr_{FLOW}$  – Water flow for bowl closing after flushing cycle,

$Closeper_{TIME}$  – Flow time for bowl closing after flushing cycle,

$Bowlfillwtr_{FLOW}$  – Water flow for bowl filling after flushing cycle,

$Bowlfillper_{TIME}$  – Flow time for bowl filling after flushing cycle,

$Makeup_{FLOW}$  – Water flow for maintaining separation process,

$Makeup_{TIME}$  – Flow time for maintaining separation process,

$Makeup_{INTER}$  – Interval for water adding to maintain separation process.

Research has been done on board ship B [5], and is presented in Fig. 7, shows that separated fuel quantity during

steaming with average fuel consumption of 20 tons/day is approximately 0.15% of fuel consumption. Obtained results are based on data of sounding purifier sludge collecting tank and subtracting consumed purifier process water. The quantity of consumed process water  $Wtr_{cycle}$  is 5.3 liters/flushing cycle and water for maintaining the separation process  $Makeup$  is 0.1 liters/hrs. The Flushing cycle is set 2 hr.

In this case following formula is obtained by linear regression:

$$Qty_{SEP} = 0,07 * Fuel_{CONSMT} - 0,122 \tag{9}$$

where is:

$Qty_{SEP}$  – Quantity of fuel components removed during separation.

R-square value for presented linear regression is 0,122, compared to logarithmic regression 0,123 or polynomial regression which is 0,145.

As fuel separation is mostly performed continuously, the formula (9) would not be accurate if other vessels operating conditions (slow speed steaming, port stay, maneuvering, waiting, etc.) are not considered. Based on research and calculations on ship C [6] model (10) is obtained for separated fuel components through the whole range of vessel operating conditions; Fig. 8.

The average removed quantity from fuel, in this case, is approximately 0.26% of fuel consumption.

$$Qty_{SEP} = 0,043 * e^{0,004 * Fuel_{CONSMT}} \tag{10}$$

R-square for this regression is 1.2%. In this case, the value of consumed process water for the fuel purifier is 4.5 liters/flushing cycle and the flushing period is set to 2h. The water  $Makeup$  value is zero in this case.

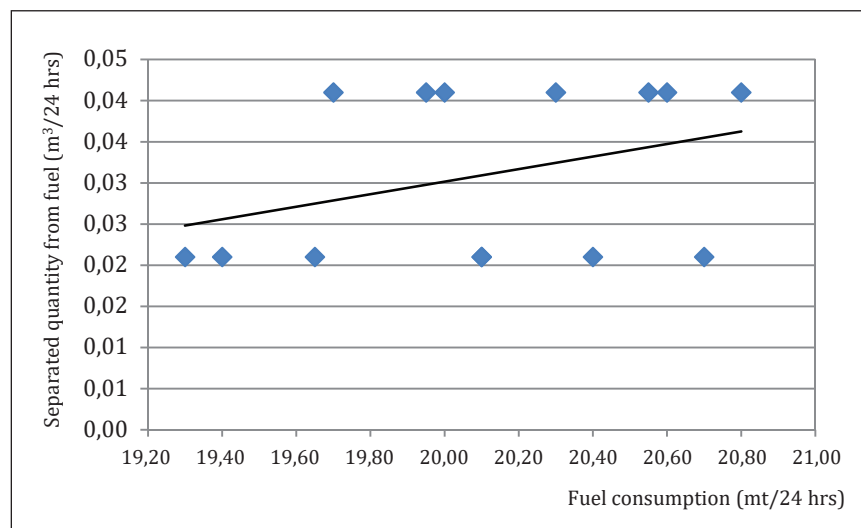

Fig. 7 Removed quantity of fuel by centrifugal purifier as a function daily fuel consumption during steaming – ship B

Source: Authors based on engine logbook extract for ship B, [5]



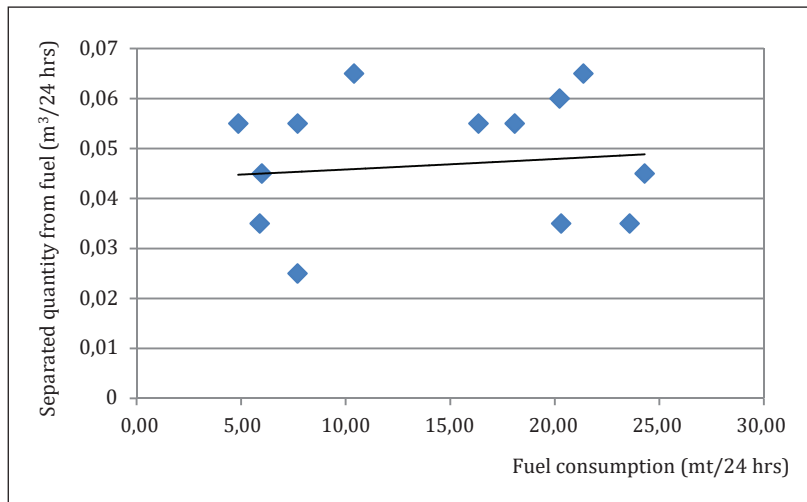

Fig. 8 Removed quantity of fuel by purifier through whole fuel consumption range – ship C

Source: Authors based on engine logbook extract for ship C, [6]

4.4 Leakages

Fuel leaks represent mass losses deviations. Leakage quantity can be measured by sounding the liquid level in the leakage collecting tank. In case that there are no other liquid sources into leakage collecting tank entrance the measurement is straightforward by the regular sounding of the collecting tank. In this case, might be possible to return leaked fuel to the consumption. Leak quantity directly depends on technical conditions and maintenance of the fuel system. In case that fuel leakage is present after the volumetric flowmeter in the flow diagram, Fig. 3, fuel flow is then calculated:

$$Fuel_{CONSM3} = \sum_{i=1}^n (Flow_{t2} - Flow_{t1}) - Fuel_{LEAK} \quad (11)$$

where is:

$Fuel_{LEAK}$  – Leaked heavy fuel in volume units observed by sounding in the leakage collecting tank [ $m^3$ ].

In the case of the possibility of returning leaked fuel to consumption, calculated by the formula (11) fuel consumption is then calculated:

$$Fuel_{CONSM3} = \sum_{i=1}^n (Flow_{t2} - Flow_{t1}) - Fuel_{LEAK} + Fuel_{RETR} \quad (12)$$

where is:

$Fuel_{RETR}$  – Leaked heavy fuel in volume units returned to consumption observed by sounding in the leakage collecting tank [ $m^3$ ].

4.5 Volumetric flow meter accuracy

Volumetric flowmeter accuracy depends on its design and is determined during calibration for each device separately. According to Faber, J. et al. (2013) [8] the general accuracy of volumetric flow meters is 0.0% -0.2%. Accuracy of flowmeter with blades which is installed on board ship A [16] depends only on the flow through the meter as presented in Fig. 9.

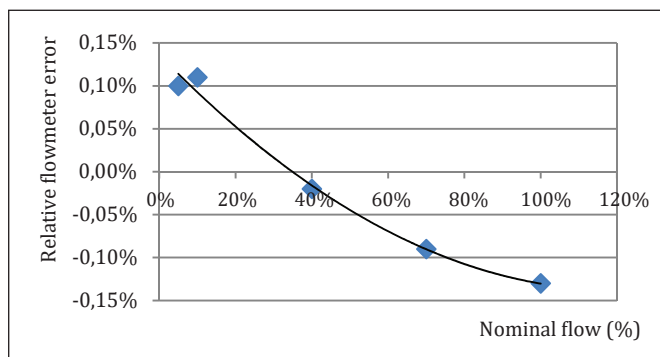

Fig. 9 Relative error of volumetric fuel flow vs. observed flow meter capacity – ship A

Source: Authors based on data in [16]

Table 4 Accuracy for volumetric fuel flow meter – ship A

| Tested capacity | Accuracy |
|-----------------|----------|
| 100%            | -0,13%   |
| 70%             | -0,09%   |
| 40%             | -0,02%   |
| 10%             | 0,11%    |
| 5%              | 0,10%    |

Source: Test and inspection certificate flow meter for VAF J5200 Series [16]

Based on table 4, obtained model by polynomial regression of the second order is:

$$Accur = 0,001 * Cap_{REL}^2 - 0,004 * Cap_{REL} + 0,001 \quad (13)$$

where is:

$Accur$  – Relative error of volumetric flow meter,

$Cap_{REL}$  – Relative flow meter capacity at which flow is measured.

R-square for this model is 0,989 and is the most accurate compared to different regressions models.

Exact flow calculation through a volumetric flow meter, in this case, would be:

$$Flow_{TRUE} = Flow_{OVB} * \frac{Accur}{100\%} \quad (14)$$

where is:

$Flow_{TRUE}$  – Calculated accurate flow through fuel flow meter [ $m^3/h$ ],

$Flow_{OVB}$  – Measured flow through volumetric flow meter [ $m^3/h$ ].

#### 4.6 Accuracy of volumetric flow to mass flow conversion

Accuracy of volumetric flow to mass flow conversion depends on two factors:

- Accuracy of volumetric flow into mass flow conversion,
- Accuracy fuel temperature readings and their oscillations during the measurement period.

The basic formula for volumetric/mass flow conversion is:

$$Fuel_{CONSTMT} = Fuel_{TRUE} * Dens_{CORR} \quad (15)$$

where is:

$Fuel_{CONSTMT}$  – Mass flow in the defined period [ $mt$ ],

$Dens_{CORR}$  – Corrected heavy fuel oil density [ $mt/m^3$ ].

Corrected density is calculated:

$$Dens_{CORR} = (Dens_{15} - 0,0011) * (1 - (T - 15) * 0,000645) \quad (16)$$

where is:

$Dens_{15}$  – Declared heavy fuel oil density at 15 °C [ $mt/m^3$ ],

$T$  – Average heavy fuel oil temperature through the flow-meter [°C].

As presented in Fig. 10, if fuel temperature passes through volumetric flow meter is 90 °C and by not implementing the required model (16) error of up to 5% in the total fuel consumption figures might occur.

For accurate conversion, it's desirable that the fuel temperatures passing through the volumetric flow meter are constant and reading is accurate. If the temperature

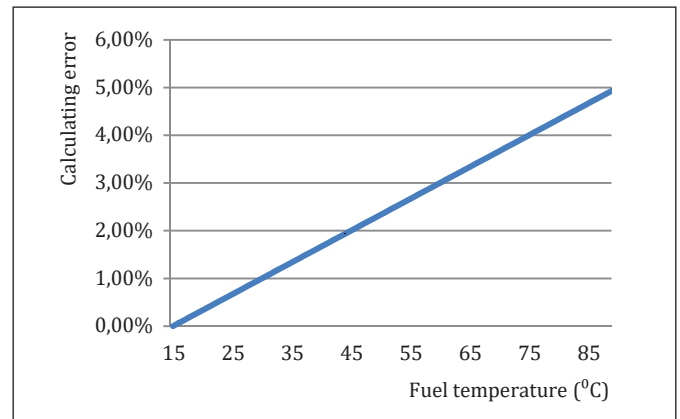

Fig. 10 Volumetric/mass flow conversion error in case not using corrected density

Source: Authors

is not constant during the designated period, an average value can be calculated by integral calculus:

$$Avg_{TEMP} = \frac{A}{(t_2 - t_1)} \quad (17)$$

that is:

$$A = \int_{t_1}^{t_2} f(t) dt \quad (18)$$

where is:

$Avg_{TEMP}$  – Average temperature during the period (t2-t1) [°C].

The most convenient solution for accurate temperature recording over time would be to have an installed data logger. Onboard examined example ships there were no temperature gauges at volumetric flow meters and service tank fuel temperature was the source of the required information.

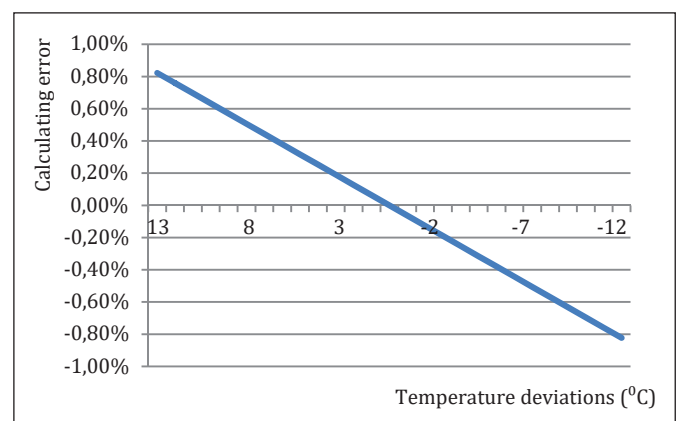

Fig. 11 Volumetric/mass flow conversion error caused by incorrect temperature measuring/calculation

Source: Authors

**Table 5** Review of deviations and errors in the calculation of ROB and fuel consumption

| Fuel preparation process     | Source of deviation/error                     | Approximate find error | Error unit/dependence        | Impact on error   |
|------------------------------|---|------------------------|------------------------------|---|
| Storage tank                 | Evaporation of VOC                            | 0,001-0,0015%          | Time/heated fuel qty         | Fuel temperature, quantity of heated fuel                       |
| Settling tank                | Evaporation of VOC                            | 0,001-0,0015%          | Time/heated fuel qty         | Fuel temperature, quantity of heated fuel                       |
|                              | Water draining                                | 0,05%-0,18%            | Based on consumption figures | Fuel water content, leaking steam heaters                       |
| Purification                 | Extraction of fuel heavy components and water | 0,15%-0,9%             | Based on consumption figures | Fuel quality, Fuel water content, leaking steam heaters         |
| Service tank                 | Evaporation of VOC                            | 0,001-0,0015%          | Time/heated fuel qty.        | Fuel temperature, quantity of heated fuel                       |
|                              | Water draining                                | 0%                     | Based on consumption figures | Incorrect operation of purifier, leaking steam heaters          |
| Flow meter                   | Flow meter accuracy                           | 0%-0,13%               | Based on nominal flow        | Flow volume   |
|                              | Volumetric/mass flow conversion               | 0%-5%                  | Based on consumption figures | Average fuel temperature accuracy, accuracy of conversion model |
| Final filtration and heating | Leakages                                      | 0%                     | Time                         | Technical condition of fuel system                              |

Source: Authors

Correct temperature monitoring or calculation errors lead to significant errors in the conversion of volumetric/mass flow. A temperature error of  $10^0$  leads to a mass flow calculation error of 0.63%; Fig. 11.

## 5 Discussion

Measurement of heavy fuel oil consumption on ships equipped with volumetric fuel flow meters and consequently declaring correct ROB greatly depends on the mass losses in the fuel preparation process and measuring/calculating errors. Those figures were practically based on approximation during normal daily operations onboard.

Based on this research and analysis, the heavy fuel ROB calculated according to formula (1) would be wrong so model (19) is to be used to include fuel mass losses:

$$Fuel_{ST} = BDN - Floos - Wtr_{DRAIN} - Qty_{SEP} - Fuel_{LEAK} - Fuel_{CONSMT} \quad (19)$$

Model (19) is used in the case that the leaked fuel cannot be returned to consumption. In opposite case model (20) is to be used:

$$Fuel_{ST} = BDN - Floos - Wtr_{DRAIN} - Qty_{SEP} - Fuel_{LEAK} + Fuel_{RETURN} - Fuel_{CONSMT} \quad (20)$$

The accuracy volumetric/flow conversion and flow meter accuracy are then combined in the formula:

$$Fuel_{CONSMT} = Fuel_{TRUE} * Dens_{CORR} \quad (21)$$

Based on done research the review of deviations and errors in the calculation of fuel consumption and consequently ROB stock are summarized in table 5.

This research shows that by obtaining daily data from fuel tanks levels, purifier sludge collecting tank level, leakage tanks is possible to generate more accurate models for calculating fuel mass losses. Incorporating measurement errors and accurate models for volume/mass flow conversion more accurate fuel consumption figures can be obtained. Consequently, fuel consumption figures have a direct impact on ROB fuel stock.

Due to the relatively limited source of data obtained from observed ships, it was not possible to more thoroughly analyze the impact of fuel type, fuel quality, and fuel water content on fuel mass losses onboard. Much more accurate models would be obtained if the analysis was done on data observed over a longer period and different vessel operating conditions. This is the area for further research and analysis. A more detailed analysis of the influence of temperature and pressure on the VOC evaporation on a particular grade of heavy fuel (according to ISO 8217-2017) should be also the subject of additional study.

## 6 Conclusion

By analyzing the fuel flow diagram, Fig. 3., some deviations and errors in the calculation of ROB stock and heavy fuel oil consumption are identified. Identified deviation and error points in the analysis are related to the evaporation of volatile fuel components in tanks during heating, removal of water by manual drainage, separation of water

and heavier components from heavy fuel, leaks, inaccuracy of volumetric flowmeters, and volumetric/mass flow conversion errors. Evaporation losses of volatile components are based on existing evaporation studies. The calculation of mass losses by removing water and heavier components from the fuel is based on data extracted from the engine room logbooks based on three different cargo ships. Statistical analysis of obtained data provides models for calculating the amount of drained water from settling and service tanks and removed components from the fuel by separation. Any leaks in the fuel system are taken empirically and should be based on measurements of actual fuel leaks onboard. Inaccurate measuring and calculation of fuel consumption generate errors which consequently cause the wrong declaration of heavy fuel oil ROB stock. By synthesizing all losses, errors in a single model and single formula for ROB stock is generated. Based on observed data the review of the calculated deviations shows errors of ROB stock declaration in the range from 0% to max 5% of the total fuel consumption per individual error point. This approach contributes to further research and a guideline for a more accurate approach towards the calculation of heavy fuel oil consumption and ROB stock onboard a vessel.

**Funding:** The research presented in the manuscript did not receive any external funding.

**Author Contributions:** Research, Josip Dujmović; Writing, Josip Dujmović, Analysis, Josip Dujmović; Review and editing, Dean Bernečić; Supervisioning, Dean Bernečić; Verification, Dean Bernečić

## Reference

- [1] Alfa Laval, Fuel oil treatment, Retrieved 3.2.2021. from the World Wide Web: [https://www.alfalaval.com/globalassets/documents/industries/machinery-and-manufacturing/power-machinery/fuel-oil-treatment\\_brochure\\_pls00056en.pdf](https://www.alfalaval.com/globalassets/documents/industries/machinery-and-manufacturing/power-machinery/fuel-oil-treatment_brochure_pls00056en.pdf)
- [2] Alfa Laval Tumba AB, (08-2016), Parameter list, S Flex Separation, Tumba, Sweden
- [3] Bunker delivery notes for ship A for period 10/2008 – 01/2009
- [4] Engine logbook extract for ship A for period 04/2008
- [5] Engine logbook extract for ship B for period 02/2020 – 10/2020
- [6] Engine logbook extract for ship C for period 02/2021
- [7] European Commission (2017), Guidance/Best practices document on monitoring and reporting of fuel consumption, CO2 emissions and other relevant parameters pursuant to Regulation 2015/757 on monitoring, reporting and verification emissions from maritime transport, Retrieved 26.01.2021.from the World Wide Web: [https://ec.europa.eu/clima/sites/clima/files/transport/shipping/docs/02\\_guidance\\_monitoring\\_reporting\\_parameters\\_en.pdf](https://ec.europa.eu/clima/sites/clima/files/transport/shipping/docs/02_guidance_monitoring_reporting_parameters_en.pdf)
- [8] Faber, J., Nelissen, D., Smit, M., (2013), Monitoring of bunker fuel consumption, CE Delft
- [9] Ford, C.M. (2012), A master's guide to: using fuel oil onboard ships, Charles Taylor & Co. Limited, London, England
- [10] Hu, G., Butler, J., Littlejohns, J., Wang, Q., Li, G., (2020), Simulation of cargo VOC emissions from petroleum tankers in transit in Canadian water, *Engineering of Computational Fluid Mechanics*, 14:1, 522-533.
- [11] Innospec, (2020), Purifier blockages when using VLSFO, Technical Bulletin, Retrieved 15.01.2021. from the World Wide Web: <https://innospec.com/wp-content/uploads/2020/10/Marine-technical-bulletin-issue-3.pdf>
- [12] International Maritime Organization (2016), MPEC.1/Circ.867, Unified Interpretations of Regulations 1.24, 12, 27 and 28.3.3 of MARPOL Annex I
- [13] Levitin, R. E., Tryascin, R. A., (2016), Determining Fuel Losses in Storage Tanks Based on Factual Saturation Pressures, IOP Conference Series: Material Science and Engineering
- [14] MAN Diesel & Turbo, Cleaning of Heavy Fuel Oil and Maximum 0,10% Sulphur Fuels, Service Letter SL2017-638/DOJA
- [15] Shell (2019), Operational guidelines for the use of Shell VLSFO, Retrieved 26.01.2021.from the World Wide Web: [https://www.shell.com/business-customers/marine/fuel/very-low-sulphur-fuel-oil/\\_jcr\\_content/par/toptasks.stream/1583826869684/c99abd63deea59887476cbca1e2893a749b1041d/operational-guidelines-for-vlsfo.pdf](https://www.shell.com/business-customers/marine/fuel/very-low-sulphur-fuel-oil/_jcr_content/par/toptasks.stream/1583826869684/c99abd63deea59887476cbca1e2893a749b1041d/operational-guidelines-for-vlsfo.pdf)
- [16] Test and inspection certificate flow meter for VAF J5200 Series, ship A