

Durability modeling and analysis of composite structures exposed to the marine environment

Vizentin, Goran

Doctoral thesis / Disertacija

2022

Degree Grantor / Ustanova koja je dodijelila akademski / stručni stupanj: **University of Rijeka, Faculty of Maritime Studies, Rijeka / Sveučilište u Rijeci, Pomorski fakultet**

Permanent link / Trajna poveznica: <https://um.nsk.hr/um:nbn:hr:187:112711>

Rights / Prava: [In copyright](#) / [Zaštićeno autorskim pravom.](#)

Download date / Datum preuzimanja: **2024-11-04**



Sveučilište u Rijeci, Pomorski fakultet
University of Rijeka, Faculty of Maritime Studies

Repository / Repozitorij:

[Repository of the University of Rijeka, Faculty of Maritime Studies - FMSRI Repository](#)





UNIVERSITY OF RIJEKA
FACULTY OF MARITIME STUDIES

Goran Vizentin

**DURABILITY MODELING AND ANALYSIS
OF COMPOSITE STRUCTURES EXPOSED
TO THE MARINE ENVIRONMENT**

DOCTORAL DISSERTATION

Rijeka, 2022.



UNIVERSITY OF RIJEKA
FACULTY OF MARITIME STUDIES

Goran Vizentin

**DURABILITY MODELING AND ANALYSIS
OF COMPOSITE STRUCTURES EXPOSED
TO THE MARINE ENVIRONMENT**

DOCTORAL DISSERTATION

Thesis Supervisor: Assoc. Prof. Goran Vukelić, Ph.D.

Rijeka, 2022.



SVEUČILIŠTE U RIJECI
POMORSKI FAKULTET

Goran Vizentin

**MODELIRANJE I ANALIZA TRAJNOSTI
KOMPOZITNIH KONSTRUKCIJA
IZLOŽENIH MORSKOM OKOLIŠU**

DOKTORSKA DISERTACIJA

Mentor: Izv. prof. dr. sc. Goran Vukelić

Rijeka, 2022.

Doctoral thesis supervisor: Assoc. Prof. Goran Vukelić, Ph.D., University of Rijeka,
Faculty of Maritime studies, Croatia

The doctoral thesis was defended on **8th July 2022.** at the University of Rijeka,
Faculty of Maritime Studies, Croatia, in front of the following Evaluation
Committee:

1. Prof. Dragan Martinović, PhD, University of Rijeka, Faculty of Maritime Studies, Croatia, chairman
2. Assoc. Prof. Radoslav Radonja, PhD, University of Rijeka, Faculty of Maritime Studies, Croatia, member
3. Prof. Željko Božić, PhD, University of Zagreb, Faculty of Mechanical Engineering and Naval Architecture, Croatia, member

Abstract

The experimental part of this research was developed, based on samples of epoxy/glass and polyester/glass composites in the form of standardized coupons, with various fiber orientation layout configurations submerged under the sea for an extended period of time (6, 12 and 24 months) in order to enable the assessment of the influence of the prolonged exposure to the sea on the mechanical properties of the material. Numerical finite element analysis (FEA) tensile test and three-point bending simulations on the coupon geometry indicated that the ultimate uniaxial tensile strength (UTS) is the most important parameter for the characterization of the structural mechanical behavior of the material. This parameter value variations were measured experimentally after each period of exposure to the sea and compared with obtained numerically values.

The research results showed that all submerged specimens have exhibited an increase in mass due to water absorption and growth of adhering algae and marine microorganisms. Furthermore, various levels of reduction in ultimate tensile strength (UTS), depending on the fiber layout configurations, were observed. Significant changes in the matrix material structure were noticed in the areas where marine organisms and microorganisms adhered to and were embedded, effectively creating “voids” in the matrix material.

Numerical analysis and simulations were conducted during the “wet” coupons’ submersion periods, yielding in a predictive model for the long-term behavior of composites in real marine environment. The model was then verified by comparison with the results of experimental tensile tests. Additionally, the usage of composites as a repair material in process equipment and structural elements made from different materials, was verified.

The research showed the importance of environmental degradation of mechanical properties of composite materials in the real marine environment. The findings of this

research could improve the technical regulations of classification societies for composite marine structures exposed to the marine environment during their service life and expand their application in this industrial sector. The design process of such structures can be further optimized by incorporating the material degradation prediction model proposed here.

Keywords: FRP composites; marine environment; material degradation; fatigue life; durability of composite marine structures

Prošireni sažetak

Eksperimentalni dio ovog istraživanja izveden je na standardiziranim uzorcima (kuponima) kompozitnih materijala izvedenih od kombinacije epoksidne i poliesterske smole kao matrice, te različito orijentiranih staklenih vlakana kao ojačavala uronjenima u more na duge periode od 6, 12 i 24 mjeseca. Svrha eksperimenta je procjena utjecaja duljeg izlaganja uzoraka moru na mehanička svojstva materijala. Numeričko modeliranje i simulacije vlačnog testa i savijanja u tri točke, primjenom metode konačnih elemenata (MKE) na odabranoj geometriji uzoraka pokazali su da je krajnja aksijalna vlačna čvrstoća (engl. *Ultimate Tensile Strength*, UTS) najvažniji parametar potreban za ispravnu karakterizaciju strukturno-mehaničkog ponašanja materijala. Promjene vrijednosti ovog parametra mjerene su eksperimentalno (vlačni test) nakon završetka navedenih vremenskih perioda izloženosti moru, te su uspoređivane sa vrijednostima dobivenima numeričkom analizom.

Rezultati istraživanja pokazali su da su svi uronjeni uzorci imali povećanu masu zbog adsorpcije vode i rasta morskih algi i mikroorganizama koji su se vezali na površini materijala. Nadalje, zamijećene su različite razine smanjenja vlačne čvrstoće materijala za različite konfiguracije usmjerenja slojeva staklenih vlakana. Značajne promjene u strukturi materijala matrice uočene su u područjima vezanja algi i drugih morskih organizama na površini i prodora mikroorganizama u matricu, čime su u biti stvorene "praznine" u materijalu matrice.

Numerička analiza i simulacije, provedene tijekom perioda uranjanja uzoraka, rezultirale su stvaranjem prediktivnog modela dugotrajnog ponašanja kompozita uslijed izloženosti stvarnom morskom okolišu. Model je provjeren usporedbom rezultata sa vrijednostima dobivenim eksperimentalnim vlačnim testovima. Povrh svega navedenog, ispitana je i potvrđena mogućnost uporabe kompozitnih materijala za popravke procesne opreme i konstrukcijskih elemenata izvedenih od drugačijih materijala.

Provedeno istraživanje ukazalo je na važnost degradacije mehaničkih karakteristika kompozitnih materijala uslijed dugotrajne izloženosti morskome okolišu. Nalazi ovog istraživanja mogu poslužiti za poboljšanje tehničkih propisa i standarda klasifikacijskih društava predmetnih za kompozitne pomorske konstrukcije koje su u svom životnom vijeku izložene negativnim utjecajima morskog okoliša čime bi se omogućila šira primjena ovakvih materijala u pomorstvu. Proces projektiranja takvih konstrukcija može se dodatno optimizirati uključivanjem ovdje predloženog modela predviđanja degradacije materijala.

Ključne riječi: vlaknima ojačani polimerni kompoziti; morsko okruženje; degradacija materijala; zamor materijala; trajnost kompozitnih pomorskih objekata

Contents

Abstract.....	i
Prošireni sažetak.....	iii
Part I Introduction.....	i
Chapter 1 Introduction	1
1.1 Composite materials in marine structures.....	1
1.2 Durability of marine structures	4
1.3 Water absorption in composites	7
1.4 Research conceptualization.....	9
Chapter 2 Experimental analysis	13
2.1 Experiment setup.....	13
2.2 Optical observations	17
2.3 Mass measurements	18
2.4 Microscopic observations.....	18
2.5 Tensile tests.....	19
Chapter 3 Numerical analysis.....	21
3.1 Tensile test numerical modelling.....	21
3.2 Material degradation prediction model.....	23
Chapter 4 Conclusion.....	25
4.1 Main Contributions	25
4.2 Future work.....	28
Chapter 5 Summary of Papers.....	29
A Effect of Time-Real Marine Environment Exposure on the Mechanical Behavior of FRP Composites.....	29
B Marine Environment Induced Failure of FRP Composites Used in Maritime Transport.....	30

C	Prediction of FRP Composites Properties Deterioration Induced by Marine Environment.....	31
D	Composite wrap repair of a failed pressure vessel—Experimental and numerical analysis.....	32
	Bibliography	33
	List of figures	41
	List of tables	42
	List of publications	43
	Curriculum Vitae	49
	Part II Included Publications.....	51

PART I
INTRODUCTION

Chapter 1

Introduction

Global intensification of maritime transport has led to an increase in emissions of harmful substances caused by the exploitation of marine facilities. The Regulatory organization (International Maritime Organization, IMO) is therefore continuously developing various strategies to reduce pollution. A strategy that is most commonly adopted to ensure reduced emissions is the improvement of the so-called Energy Efficiency Design Index (EEDI), primarily through the advancement of propulsion systems. An alternative approach to improving efficiency is to reduce the total mass of marine structures, thereby improving the ratio of the mass of the cargo and the total mass of the means of transport.

Composites as structural materials offer a number of advantages over the more traditional materials such as metal and wood in any industry sector. Perhaps the most prominent of their positive properties is excellent strength to weight ratio, nearly unlimited flexibility in designing shapes and forms, the adaptability to loading conditions by customizing fiber directions according to principal loads, lower volumetric cost, and the possibility of on-site manufacturing and repair.

The main research question for this research was whether a numerical model of environmental degradation for FRP composites can be developed in order to improve classification rules, recommendations and practices regarding the use of such materials for marine structures.

1.1 Composite materials in marine structures

Marine structures (ships and offshore facilities) are still largely constructed from traditional materials (primarily steels), while modern materials such as fiber reinforced polymer composites (FRP composites) are still not significantly

represented, although they are widely used in the rest of the transport industry (air and land transport). Composite materials have been used to a lesser extent in marine structures in both the civilian sector (small vessels) (Chandrasekaran, 2015; Greene, 1999) and the military sector (Mathijssen, 2016) since the middle of the twentieth century. Lightweight and durable, modern materials can bring progress to the conservative maritime industry through weight reduction, decreased environmental impact, increased propulsion efficiency, reduced vessel maintenance intervals, extended service life, and increased payload (Chalmers, 1994; Graham-Jones and Summerscales, 2015; Neşer, 2017; Rubino et al., 2020).

Likely the most important advantage of composite materials is their adaptability to specific application requirements by defining layup sequences, number of plies, and fiber orientation in the principal loading directions (Brčić et al., 2021; Gljuščić et al., 2021; Venkatesan et al., 2020). This flexibility in application makes FRP composites increasingly appealing to engineers when designing marine structures of complex shapes (Saravanan and Kumar, 2021).



Figure I.1 Composite ship hull section (source: <http://www.fibreship.eu/fibreship-2nd-public-workshop/>)

By the end of the last century, composite materials began to be increasingly used in structural elements of ships hulls (Diez de Ulzurrun et al., 2007; Yang et al., 2021), superstructures (Chen et al., 2021; Grabovac et al., 1993), docks, bulkheads (Tamboura et al., 2022; Xie et al., 2018), modern mast systems (Yoon and Park, 2021), propellers (Mulcahy et al., 2010), shaft line elements (Litwin, 2019; Prasad et al., 2018), rudders (Neuschwander et al., 2019), piping system elements on ships and offshore (Lukács et al., 2021), valves and machine elements on ships (Kim et al., 2021; Mouritz et al., 2001) and auxiliary structures (Fang et al., 2016; Wang et al., 2019). Two areas where the application of composite materials is increasing significantly are offshore platforms (Lin et al., 2021; Setvati et al., 2014; Yasar et al., 2014) and renewable energy sources installations (Davies et al., 2013; Gonabadi et al., 2021; Grogan et al., 2018).

Composite materials are also used in the repair of structures made of other materials, especially pressure pipelines and equipment (Ali Ghaffari and Hosseini-Toudeshky, 2013; Echtermeyer et al., 2014; Karbhari, 2015), which is of significant interest for marine structures. Repairs are performed in the form of patches made of composites that are glued to the damaged areas (Alizadeh and Dehestani, 2018; Ayaz et al., 2016; Saeed et al., 2014). In such cases, different materials are bonded (e.g. composites with steel) (George et al., 2021), so a special area of research on the impact of water penetration on these joints is opened, all with the aim to preserve the integrity of the structure. This aspect of the application of composite materials is also considered in this research.

In general, the main advantages of using composite materials compared to traditional shipbuilding materials (wood, steel) are the reduction of the total mass of building structures, improved resistance of materials to degradation and fire resistance. Reduced fuel consumption per amount of cargo transported by reducing the weight of the vessel, of course, reduces the emission of harmful substances into the environment.

In order to enable the application of composite materials, or any other materials for that matter, to marine structures, designers must comply with classification societies regulations. On the other hand, the design process requires the usage of reliable tools

and/or prediction models that must be accurate, verified, and with clearly known limits of applicability (DNV, 2014).

1.2 Durability of marine structures

As the application field for marine composites widens, so do the requirements for mechanical and environmental resilience. Limit stress states, durability and service life, failure modes, fracture toughness, fire resistance, and environment influence parameters are crucial for an efficient, sustainable and safe design process for structures in this demanding industry (Kastratović et al., 2021; Sousa et al., 2020; Tomasz et al., 2022; Vizentin et al., 2021).

Rules and regulations issued by classification societies do acknowledge the possibility of the FRP composite as structural material, but the currently valid design procedures for such materials are still based on design procedures originally defined for steel and wood. This raises the question of whether this kind of design approach is suitable for composite materials exposed to the harsh operating conditions of a real marine environment.

The assessment of the operational suitability of facilities intended for use in the marine environment (vessels and offshore structures), the so-called "Class" or classification, based on the evaluation of structural strength, the usability of materials in the construction, durability during service life, the impact of operating regimes, cost-effectiveness of construction and operation, ecology, safety of operation and technical quality of devices, machines and equipment used in the facilities. The classification procedure is subject to strict rules and technical standards of classification societies (associated in IACS - *International Association of Classification Societies*) which define the technical requirements for evaluating maritime facilities from these aspects. Equally important are the procedures for continuous supervision and control of compliance with requirements, also defined by classification societies.

The durability and reliability of marine structures is significantly affected by the impact of the environment on the behavior of maritime facilities during operation (degradation caused by environmental conditions). Traditionally, the materials which are accepted by classification societies for the construction of maritime facilities are wood and steel. On the other hand, the constant development of theoretical and

practical knowledge of composite materials opens the possibility of more intensive use of composites as a substitute for traditional materials.

There are three basic parameters that affect the durability and integrity of a composite structure exposed to the marine environment: mechanical loads, high hydrostatic pressure and diffusion of seawater into the material (Alam et al., 2018).

The lack of data on the behavior of composite materials after long-term use and exposure to marine environment, as well as a specific numerical model based on data collected in real rather than laboratory conditions (usually accelerated aging of samples in climate chambers) hinders the development and intensification of the use of composite materials in marine structures.

The results of mechanical properties testing are the basis for further development of theoretical models for predicting the behavior of composite marine structures. Such theoretical models must consider aspects of strength, stability and durability of the structure, the environmental impact on the structure as well as the impact of the structure on the environment. Composite materials are relatively modern materials whose properties, and especially long-term properties such as durability and material fatigue are not sufficiently described through theoretical models and standardization.

The analysis and design of structures that are exposed to environmental influences during their lifetime must include a stochastic approach in defining the intensity, duration and character of structural loads. Marine structures and vessels are an outstanding example of the significant impact of aggressive and extreme environments on the system's life span. Loading conditions for marine structures vary by season and geographical location.

If the effects of the marine environment on the durability and mechanical properties of composite materials in marine structures are to be evaluated, data on material properties must be collected by conducting reliable and comprehensive testing in the form of long-term exposure to the marine environment (humidity, pH, temperature, long-term stress, ultraviolet radiation as well as various combinations of the above). This approach is a classical one and has significant drawbacks as realistic structural modeling environmental input design parameters for marine structures largely depend on the stochastic environmental loading conditions and the influence of sea dwelling organisms acting simultaneously on the structure.

The classical approach to the analysis of structures in general, including marine structures, is extremely deterministic, with the material properties and structure dimensions usually being determined according to the highest expected load by applying safety factors. More recent standards prescribe certain requirements that a structure must meet, with the probability of failure or rupture of the structure playing a significant role. The safety factors of the structure are also defined based on this probability. Establishing this type of standard requires extensive knowledge of material properties and possible behavior of the system under different load conditions, including those arising from the condition of the environment.

Such an investigative approach provides insight into the properties of a material only for the conditions under which the tests were performed, resulting in the design of uneconomical structures with a high safety factor under different load conditions and environmental conditions. The main problems that arise during this kind of research are the time required to perform the test, i.e. the duration of the process of water absorption into the composite structure, modeling the long-term environmental impact on mechanical properties, modeling the mechanical-chemical process of water absorption and penetration, and many parameters that must be recorded during the test to describe the mechanical properties of the composite material after a certain period of exposure to the environment. Most often, such tests are performed in simulated conditions of accelerated aging in climate chambers.

In order to enable the optimization of structures by applying the collected data on environmental impact already in the design phase, tests should be performed on samples (coupons) to determine the properties at the level of the material and on the components of structures in the right size during operation. This would consider the influence of mechanical loading on the processes of changing material properties, all in order to develop a model for predicting the behavior of materials, structural components and the entire structure during the life cycle of marine structures.

The load on marine structures is extremely stochastic, which introduces a certain unreliability into the design and analysis processes. To mitigate the effects of these uncertainties, it is necessary to incorporate appropriate methods for modeling the actual mechanical and biological (growth of marine organisms on the structure) load. A common engineering approach to incorporate such undefined, random loads into a

design is to select mathematical models for the statistical distribution of the frequency and intensity of the corresponding physical quantity. In addition to the random nature of these loads, there is also a high probability that load intensities during the life span of marine structures will exceed the safe load limits predicted in the design.

In summary, the lack of a reliable numerical model for predicting the stochastic effects of the real marine environment on the mechanical properties of composite materials due to water penetration into the composite matrix prevents optimization of the design process, which ultimately leads to uneconomical and oversized structures, and has negative effects on the integrity of the structure and the economy of maritime facilities during long-term exploitation, indicates a scientific research problem.

1.3 Water absorption in composites

Water absorption into the composite matrix is a key phenomenon that needs to be considered when assessing the durability of marine structures. Aging of polymer composites in the marine environment has been recognized as a pervasive problem for marine structures (Alam et al., 2018; Tamboura et al., 2022; Vizinin and Vukelic, 2019) that causes degradation of mechanical properties, shortens the life and integrity of the structure and increases the likelihood of premature catastrophic structural failure. The absorption process itself is extremely complex and can depend on the type of resin and hardener, voids in the matrix, properties of selected fiber types (dry fibers, pre-resin impregnated fiber textiles, composite production process, etc.) (Bian et al., 2012).

The most commonly adopted model of water absorption in a composite is the Fick model, which has been shown to be adequate for plate and thin-walled composite elements (Eslami et al., 2015). However, recent research indicates the need to develop new models of water diffusion in the matrix due to the complex nature of this phenomenon (Bond, 2005; Grace, 2016; Joliff et al., 2014, 2013; Peret et al., 2019, 2014). The tendency in research on this issue is to develop a unified procedure (experimental, analytical and numerical) for modeling the diffusion of water into typical structural elements (Gagani et al., 2018; Rocha et al., 2017).

Efforts to investigate the impact of the marine environment on composite properties are noteworthy (Afshar, 2017; Afshar et al., 2020; Bazli et al., 2016; Bian et al., 2012;

Zayed et al., 2018). However, there is still a lack of knowledge about the behavior of FRP composites when considering long-term exposure to seawater, its entry mechanism into the structure of materials, the dynamics of moisture distribution coupled with hydrostatic pressure, and exposure to water pollution under real conditions. Previous research on this or related topics has focused exclusively on experimental, numerical or analytical approaches (Dong et al., 2016; Peret et al., 2017; Zhang and Xiao, 2017).

Most researchers opt for a simulated marine environment (immersion of samples in the so-called artificial sea in tanks) as the medium in which the tests are performed and/or accelerated aging procedures in climate chambers to save time during the tests. In this case, the study does not consider the impact of marine pollution and development of marine organisms that have adapted to life on the surface of artificial materials on the mechanical properties of the structure that has become their habitat. This problem has become of interest to many researchers in the last decade (Abioye et al., 2019; Muthukumar et al., 2011; Telegdi et al., 2016).

The topic of durability of composite materials in marine structures is gaining in importance precisely because of the need to develop physically based models for predicting the durability of composites and the integrity of composite marine structures in the marine environment (Davies and Rajapakse, 2018, 2014).

There is no comprehensive study that would provide a complete insight into the behavior and, ultimately, the failure of composites under the long-term influence of the real marine environment and the distinctly stochastic nature of the load on the structure resulting from environmental conditions. The results of these studies should provide a better understanding of the afore mentioned effects on fracture mechanics (Zhao et al., 2016) and improve the design procedures of composite marine structures by increasing the reliability in the assessment of durability and integrity of marine structures. Useful experimental data, a developed numerical model for further use on a multilevel scale (You, 2009a, 2009b) and improved analytical solutions (Caliri et al., 2016) that consider the exposure to the marine environment are expected.

A common engineering approach to incorporate such undefined, random loads into a design is to select mathematical models for the statistical distribution of the frequency and intensity of the corresponding physical quantity (Chen and Guedes Soares, 2008).

In addition to the random nature of the environmental loads, there is also a high probability that load intensities during the lifetime of marine structures will exceed the safe load limits predicted in the design stage. It is becoming clear that the deterministic approach is not adequate (Young et al., 2010).

Therefore, extensive scientific research is needed to develop numerical models, methods and tools to predict the long-term effects of environmental factors, as well as the combination of environmental factors and production processes and their effect on the mechanical properties of composite materials during the service life of marine structures. The application of such numerical prediction models would certainly enable a comprehensive design and production process with optimization of the structural elements and the entire system during each step in the process of creating the final product, thus resulting the optimization of marine structures, both in technical and economic terms.

1.4 Research conceptualization

The research subject of this dissertation is to investigate and determine the intensity of water absorption into the matrix of composite material exposed to seawater, to quantify the impact of the same on the mechanical properties of composites depending on the duration of exposure to the marine environment. The findings will be paired with the stochastic model of environmental loads variations in marine structures in order to develop a comprehensive model to ensure the integrity of marine structures constructed using composite materials. All this is meant to confirm the hypothesis that there is a possibility to improve the technical regulations of classification societies for composite marine structures and extend their application by developing numerical tools for assessing changes in the mechanical properties of composites exposed to marine environment in the long term.

All these aspects prompted the research purpose, which is to analyze the impact of the marine environment on the mechanical properties and durability of composite materials and evaluate possible numerical models that will consider the stochastic nature of the variability of the impact of the environment. This would result in tools that could help classification societies adapt existing technical regulations concerning composite materials. Adaptation of regulations will enable wider application of

composites in marine structures, which opens the way for the construction of lighter, more economical and energy efficient vessels and offshore structures.

The goal of the research is to develop a stochastic structural numerical model, capable of predicting the degradation of the mechanical properties of composite marine structures due to long-term exposure to the marine environment.

The research is divided into 5 phases, as follows:

- **First phase:** a review of available literature and knowledge on structural models of composite materials and polymer matrix/fiber bonds, environmental impact, especially marine, on mechanical properties of composites with an emphasis on the impact on durability and reliability of marine structures during service life.
- **Second phase:** experimental study of the environmental impact on the composite material samples. Changes in the mechanical properties of the composite material (breaking strength, toughness), the occurrence of stress concentrators and fatigue indicators of the material, as well as morphological structures at the microscopic level are documented. Testing the impact of absorbed seawater is performed on samples (coupons) under real conditions by immersion in the sea in the Bay of Rijeka for a period of 6, 12 and 24 months. The tests are performed in accordance with the international standards ISO 527, ISO 2818, and ASTM D 3039.
- **Third phase:** development of a numerical structural model for predicting mechanical behavior of composite materials exposed to the marine environment, based on the data collected in the second phase and a stochastic approach to determine the value and frequency of input load parameters. The interdependencies of static and dynamic stresses with the effects of water penetration into the matrix of composite materials, and consequently the influence on the mechanical properties of the material are determined.
- **Fourth phase:** the developed stochastic structural model is applied to the analysis of typical structural elements of maritime facilities, with an evaluation of the possibilities of improving the efficiency, economy and environmental acceptability of the facility. In addition to the above, the applicability of the

model in the process of repairing marine structures using composite materials is analyzed.

- **Fifth phase:** compiling a set of conclusions that can be used to improve regulations, recommended practices, and standards in order to modify the technical rules based on the knowledge acquired during the research.

Chapter 2

Experimental analysis

Based on the initial survey of existing research in this area, the experimental analysis procedure was defined. The predominantly used composite materials in the maritime industry are identified through a study of recent applications in shipbuilding and offshore facilities construction. As water absorption is known to be the most important factor influencing the composite material integrity when exposed to the environment, the experimental phase of the research involved submerging coupons (specimens) in the sea and testing the mechanical properties over various time periods.

The data on composite material failure are mainly collected experimentally. The main issue here is the cost and time required for such experiments if all aspects of the real marine environment is to be taken into consideration. Nonetheless, the real marine environment differs significantly from artificial conditions created in a laboratory, so this research strives to identify the most important influences of the sea on the mechanical properties of composite materials.

2.1 Experiment setup

The experimental part of the research is performed using standardized glass fiber reinforced polymer materials (INTERNATIONAL STANDARD, 2020; ISO 2818, 2018), with three different fiber layup configurations, namely:

- unidirectional – designated UD0°,
- cross-ply – designated (0/90)_s,
- angle-ply – designated (0/±45/90)_s.

The coupons are cutouts of 300×450 mm rectangular plates, produced for each of the material combinations using 8 plies of the 0,35 mm thick UD fabric (lamina) per plate.

The epoxy/glass plates are manufactured by vacuum assisted infusion process, resulting in 3 ± 0.2 mm thick plates, whilst the polyester/glass plates are produced by hand layup process, resulting in 5 ± 0.5 mm thick plates. The dimensions chosen for the coupons are 250×25 mm, as shown in Figure I.2.

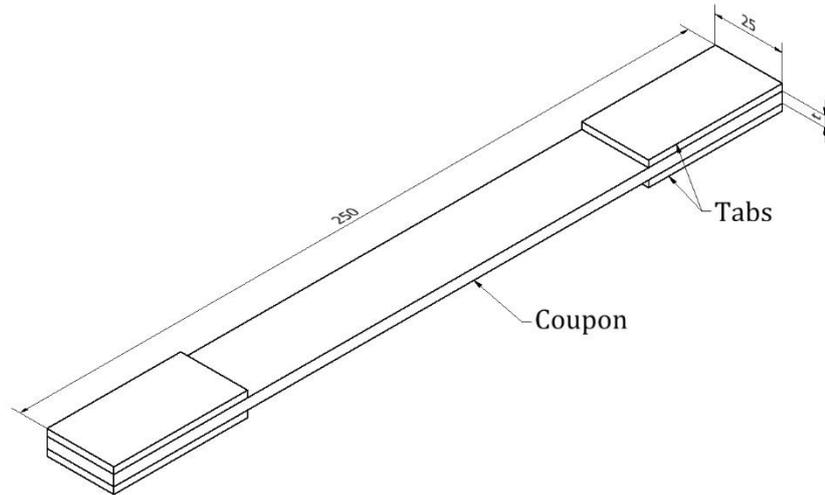

Figure I.2 Coupon dimensions

The notation used in the designations of fiber layout orientation configurations are based on the description of the lay-up sequence of prepreg laminas of the same thickness, which is the case in this study (Milenkovic et al., 2021). The laminas are numbered starting at the bottom and the angles are given from bottom up, as illustrated in Figure I.3.

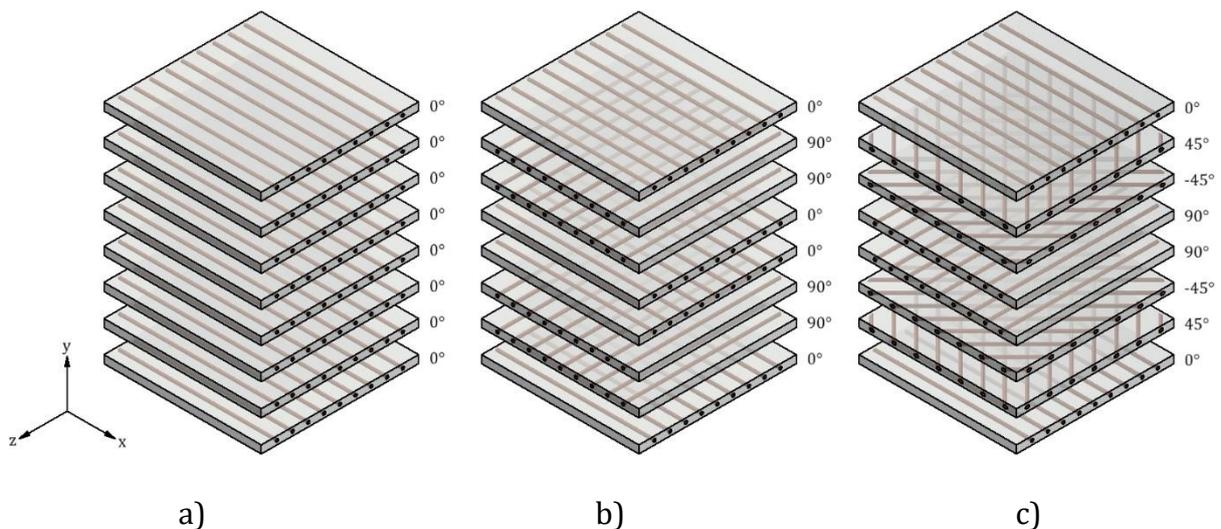

Figure I.3 Fiber layout configurations: a) UD_0° , b) $(0/90)_s$, c) $(0/\pm 45/90)_s$ coupons

For symmetric lamina layup an abbreviated notation is used where only half of the stacking sequence is given and a subscript (s) is added to specify the symmetry.

Two types of resin are used as matrix materials, i.e. the epoxy resin (Sicomin SR 8200 and SD 720 series hardener) and polyester resin (Reichhold POLYLITE 507-574). The main mechanical characteristics of the selected resin systems are given in Table 1.

Table 1 Resin systems basic mechanical properties

Property	Epoxy	Polyester
Tensile strength [MPa]	47	42
Elasticity modulus [MPa]	3,240	2,700
Glass transition temperature [°C]	50	55

The material of the fiber chosen here is E-glass in the form of fiber mat fabric (Sicomin UDV600), with 594 g/m² ply specific area weight, due to its combination of mechanical performance characteristics, corrosion resistance and low cost which make this type of glass fiber the most commonly used one as reinforcement in FRP composites.

Vacuum assisted infusion process was used for the epoxy/glass coupons and hand layup process was used for the polyester/glass coupons. Reinforcement tabs, made of printed circuit board cutouts and glued at coupon ends prior the tensile test minimized the influence of the tensile test machine's grips pressure on the test results (Belingardi et al., 2011). The size of the tabs was chosen based on ISO 527-4 recommendations.



Figure I.4 Coupons with tabs before submersion

Composite marine structures are usually protected against the negative effects of the marine environment by a final gel-coat resin-based finishing layer. This material cures into a hard, shell-like casing. This layer should protect the structure from UV rays and harmful corrosive chemical reactions. However, if this protective damage becomes damaged (fading and cracking due to UV radiation exposure, oxidization, impact with heavy objects, repeated stress, warping from the sunlight over time etc.), the composite material underneath becomes exposed. It is not uncommon that the structure beneath becomes damaged as well, especially during impact. To determine if the presence of such points on the material has any influence on the long-term behavior of the composite material exposed to the real marine environment, damage spots were introduced intentionally in several coupons during waterjet cutting. The known issue of cracking that brittle materials undergone the first impact of the cutting waterjet on the material is exploited here to create these damage points inside the gauge length of the coupons.

The majority of available studies concerning the environmental degradation of composite material properties are based on laboratory experiments that either simulate a real environment (Choi et al., 2019) or are conducted in an accelerated manner (Kovač et al., 2021). The operational environment of marine structures is harsh and corrosive and the required operational life time is significant. A gap in the pertaining research is noticeable when it comes to experiments that are conducted in the natural environment for prolonged periods of time (Vukelic et al., 2021).

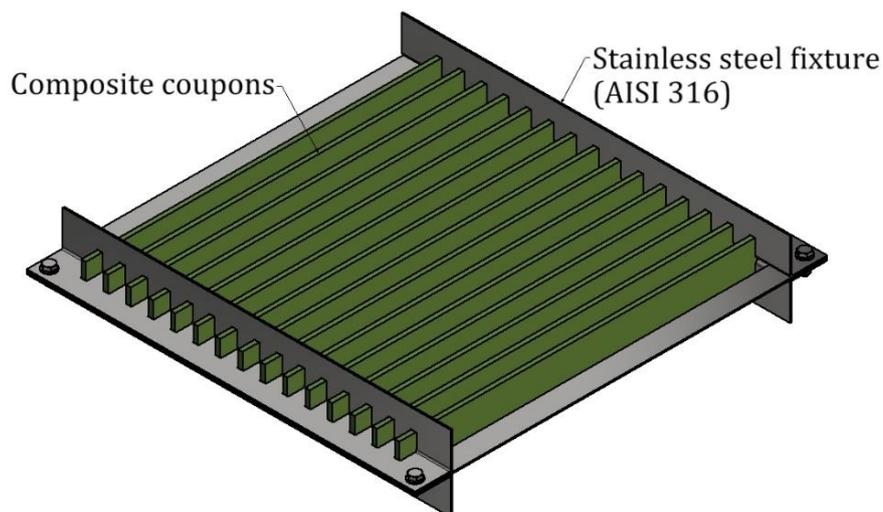

Figure I.5 Stainless steel fixture 3D CAD model

Specially designed stainless-steel submersion fixtures, Figure I.5, facilitated the submersion in the sea, assuring a fixed position on the sea bed.

Groups of coupons were scheduled for submersion in a real marine environment (depth of 10 m in the northern Adriatic off of the city of Rijeka), for 6, 12 and 24 months. An additional group of coupons is to be kept “dry” (room conditions) as a reference group. The sea conditions at selected sites are: sea temperature at the location of experiment varies between 10–14 °C annually, salinity varies between 37.8–38.3 PPT, while the pH value is between 8.22–8.29 (Institute of Oceanography and Fisheries, 2012).

After each of the indicated time periods the coupons were taken out of the sea for analysis of changes in morphological and mechanical properties. The experimental analysis was comprised of optical observations of the coupons’ geometry and surface changes, mass measurements of dry and submerged coupons, optical and scanning electron microscopy and tensile testing.



Figure I.6 Coupons in frame after 6 months of submersion

2.2 Optical observations

Significant accumulation of various marine organisms is expected to be observed on all coupons. The combined mass gain due to growth and attachment of algae/marine organisms and water absorption for both matrix resins is expected to intensify with

increasing coupons submersion time. This phenomenon underscores the importance of including aspects of real marine environment exposure as opposed to idealized laboratory conditions and accelerated aging environments predominantly used by researchers.

The superficial changes in coupons are monitored and photographically documented to enable comparison for various stages of the research (Vizentin et al., 2021).

2.3 Mass measurements

Monitoring the mass of the coupons during the submerging period yields a model of mass gain due to seawater absorption in the composite matrices. Each coupon is weighed using the same digital scale (200 g measuring range and 0.01 g resolution) in the dry state and after the submerging period to determine the mass gain of the absorbed seawater. The coupons are measured with both attached and cleaned organisms.

Special care must be taken in cleaning the adhering marine organisms from the coupon surface to prevent damage that could affect the test results. Cleaning must be done while the coupons are still submerged to prevent air drying which would skew the results. The excess water that has settled on the surface of the coupon is removed by draining and superficial drying with a cloth. The entire procedure is kept under 1 minute (Vizentin et al., 2021).

2.4 Microscopic observations

Optical (Olympus SZX10 stereo optical microscope and Olympus BX51 SM optical microscope analysis system) and scanning electron microscopy (SEM, FEI QUANTA 250 FEG with the OXFORD INSTRUMENTS PENTAFET, UK, Energy Dispersive Spectroscopy (EDS) analysis module) are used to identify and monitor morphological changes in the structure of the coupons as well to identify structural changes in the material on the microscopic level.

Special attention is to be paid to the areas where fracture occurred during the tensile test, as these locations represent the part of the material that has been most affected by exposure to the marine environment (Vizentin et al., 2021).

2.5 Tensile tests

Tensile tests performed on all coupons on the same testing machine (Zwick 400 kN universal testing machine coupled with a BTS Exmacro-H02 macro extensometer, Figure I.7) are instrumental for determining changes in ultimate tensile strength (UTS) for the coupons exposed to the marine environment compared to the reference values for the dry coupons.



Figure I.7 Coupon on completion of the tensile test

The UTS of a composite is theoretically dependent on the matrix and fiber materials chosen, fiber orientation, volumetric content of the fibers in the composite material itself. The aim here is to establish the basic material data set that will be used to

develop a numerical model for predicting fatigue life degradation of fiber-reinforced (FRP) composite materials exposed to real marine environments over extended periods of time.

The UTS of the material, along with the actual stress that a structure has to endure during the exploitation period, is the basic parameter used to determine fatigue life of the material. A fatigue failure model for glass fiber composites is described in this research. It is worth mentioning that the loads on marine structures and vessels depend mainly on environmental and operating conditions (DNV, 2014). The most influential are wave, wind, and water current loads. Ocean waves are predominantly irregular and random in shape, height, length, and propagation speed. However, for structural design properties, this load can be simplified by deterministic or stochastic methods. To determine the quasi-static response of marine structures and vessels, design procedures prescribed by classification societies allow wave loads to be defined by wavelength and corresponding wave period, wave height, and crest height (DNV, 2021).

The aim of this research is, thus, to determine the correlation between the exposure to the marine environment based on time of exposure and changes in the fatigue life behavior of composite marine structures and to validate the need for modification of the existing process used for obtaining composite material S–N curves in marine structures (Vizentin and Vukelic, 2022a).

Chapter 3

Numerical analysis

Experimental and numerical analysis results need to be compared so that a valid numerical model of the material behavior under loading can be developed and subsequently used for similar loading conditions.

3.1 Tensile test numerical modelling

A composite material is by definition a material produced from two or more distinct constituent materials that have different chemical and physical properties and are combined to create a “new” material with a new set of properties different from the constituent’s properties (Barbero, 2017). This material is inherently orthotropic and numerical modelling for FEA (Finite Element Analysis) applications can prove to be challenging, especially at the micromechanical level.

In practice, marine structural design engineers tend to “by-pass” the often complicated and time consuming microlevel models and try to use macro models-based design tools, thus ignoring this aspect in the design process and turning to rules and procedures which can be conservative, empirical, and do not completely encompass all the specificities of newly emerging materials such as FRP composites.

The ANSYS® FEA software package contains the ACP (ANSYS® Composite PrepPost) (Ansys inc., 2022) add-in that can be used to model the composite material of various fiber layout configurations and geometries. In this dissertation, the ACP add-in is used in pre- and postprocessing of FEM (Finite Element Modelling) data as it considers the layered structure of the composite material.

The coupon geometry is very regular and thin so shell finite elements can be used to model the geometry enabling the optimization of time and hardware resources needed

for FEA. In this research the FE model was meshed using 4-node shell elements with six degrees of freedom at each node, namely translations and rotations in and about the 3 coordinate axis directions (ANSYS element designation SHELL181 (Ansys inc., 2021a)), comprising 1034 nodes and 930 elements in total. There was no need for a larger number of elements since the solution converged.

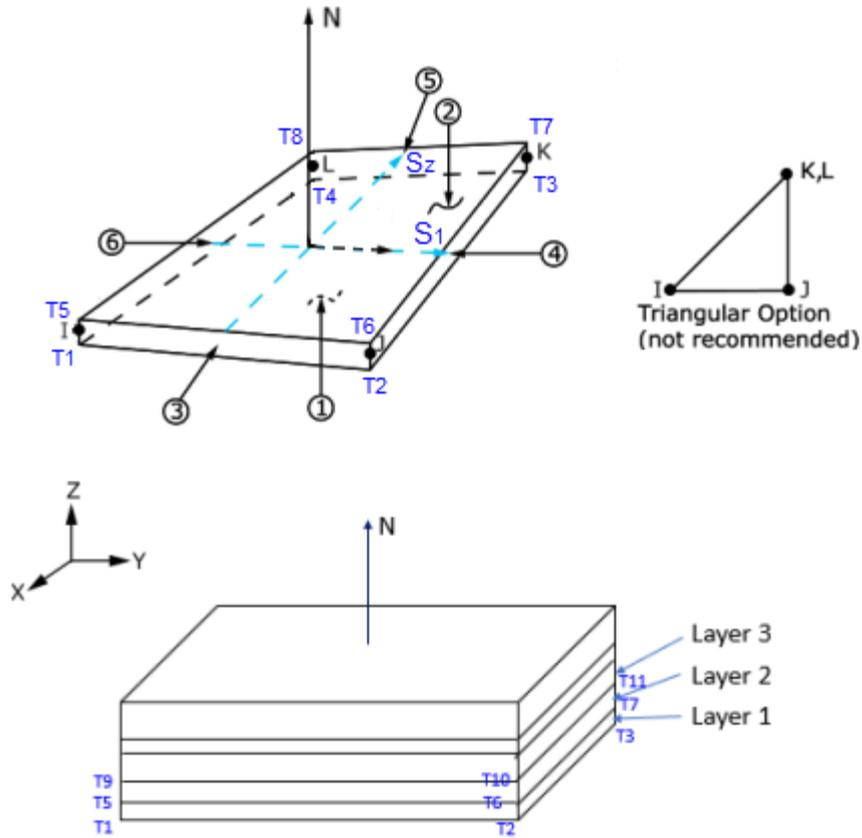

Figure I.8 ANSYS SHELL181 element geometry (Ansys inc., 2021a)

The critical loads can then be identified ply-wise by applying the software built-in first ply failure (FPF) criteria functionality for any fiber layout configuration. This critical load is actually the load at which the first failure occurs in any layer of the coupon FEM model. Any of the included and widely accepted (Ansys inc., 2021b; Hinton et al., 2004; Rahimi et al., 2012) criteria indicators theories, namely maximum strain and stress, Tsai-Wu, Tsai-Hill, Hoffman, Hashin, Puck LaRC and Cuntze, can be applied during the analysis.

The results obtained numerically must be compared with the experimental ones to validate the FE model (Vizentin and Vukelic, 2022b).

3.2 Material degradation prediction model

The UTS variation data collected in the experimental phase of the research is used for regression analysis in order to obtain a mathematical model for strength degradation correlated to the material exposure time in the marine environment. The obtained mathematical model can then be used to predict the loss of strength for a required time period in the future.

Marine structures (vessels and offshore) and any components used must undergo a certification process prescribed by the regulations in order to prove their safety and functionality up to the end of their design life, which typically spans from 25 to 40 years. Current regulations tend to make very conservative assumptions regarding long-term structural behavior, mainly due to the lack of detailed data. For example, the DNV standards (DNV-OS-C501, 2010; DNV GL AS, 2017) prescribe the procedures for identifying critical failure mechanisms and the need for redesign if required. The qualification process for a marine structure or a vessel requires identification of static strength, resistance to cyclic fatigue (full fatigue analysis using SN curves at different R-ratios required), stress rupture, damage tolerance and environmental effects on the structure.

Classification societies prescribe the procedure for obtaining S-N curves for composite materials. Various authors have reported results in modelling S-N curves for composites (Burhan and Kim, 2018; Vázquez et al., 1998; Yasar et al., 2014) and predicting the fatigue life of composite structures (Djeghader and Redjel, 2017; Kim and Huang, 2021; Silvera et al., 2011). A failure model for groups of similar fiber/matrix combination composites as the ones used in this research, can be defined in the form of:

$$\log(N) = \alpha \left(\frac{\sigma_u}{\sigma_{\max}} \right)^\beta \quad (1.1)$$

where N is the number of fatigue life cycles, σ_u is the ultimate tensile strength (UTS) value, σ_{\max} is the maximum tensile stress occurring in the loaded structure, α and β are experimental data fitting coefficients (Silvera et al., 2011).

In this dissertation, the results of the regression process are obtained based on data gathered for UD0°, (0/90)s and (0/45/90)s fiber layout configurations. The model of

regression that showed the best correlation to the experimental data was an exponential equation in the form of:

$$\sigma_u = Ae^{Bt} \quad (1.2)$$

where σ is the tensile strength value, t is the time of exposure to the marine environment and A and B are experimental data fitting coefficients. The coefficient A represents the average ultimate tensile stress of the non-submerged specimens tested.

By combining equations (1.1) and (1.2) a modified S-N curve equation can be obtained in the form of:

$$\log(N) = \alpha \left(\frac{Ae^{Bt}}{\sigma_{\max}} \right)^\beta \quad (1.3)$$

This model can now be used to predict the variations in the S-N curves caused by the change in the ultimate strength value of the samples due to the degradation of the mechanical properties of the composite material exposed to the marine environment. The described phenomenon directly affects the traditionally calculated expected fatigue life of the structure.

Chapter 4

Conclusion

4.1 Main Contributions

This dissertation focuses on determining the effects of a real marine environment on the mechanical properties of composite marine structures in real-time analysis. Epoxy/glass and polyester/glass composite coupons (specimens) were used to study and model the deterioration of the material's mechanical properties. The research has proven that the real marine environment has considerable effects on composite materials in the form of reduced mechanical strength, which differ from the effects observed in laboratory conditions.

The main contributions of this research can be summarized as follows:

- The growth of microorganisms embedded in the resin and invertebrate organisms (Nematoda) attached to the surface of the coupons, both originating from the real marine environment, effectively created voids in the matrix resin and directly affected the mechanical properties. This is a direct indication of the importance of testing in a real environment versus the somewhat idealized, and more commonly used, laboratory conditions of climate chambers and artificial seawater environments that do not contain any marine organisms.
- Data collected during the experimental phase of the doctoral research represents a contribution in itself due to the fact that only a small number of marine composite standards and researchers address long-term material properties in a real marine environment. The loss of ultimate tensile strength identified by the experimental part of this research indicated that corrections of the existing procedures used for predicting the fatigue life of composites exposed to the sea is required.

- A basic durability assessment model is proposed that can be used to predict fatigue life degradation of fiber-reinforced (FRP) composite materials exposed to real marine environments for prolonged periods. The data collected during the research were used to perform a regression analysis with the goal to obtain a mathematical model for the strength degradation correlated to the exposure time in the marine environment. The obtained mathematical model can be used to predict the loss of strength over prolonged periods of time
- The study on the necessity of modifying the process used for obtaining composite material S-N curves, considering the influence of the marine environment, has been conducted taking into consideration the technical standards, recommended practices and certification process of marine industry sector classification societies. The research which resulted in this dissertation has shown that the long-term properties of composite materials exposed to the demanding marine environment must be determined in order to integrate the durability issues into the design standards. Current regulations tend to make very conservative assumptions regarding long-term structural behavior, mainly due to a lack of detailed data. Fatigue life decrease model has been proposed for three most commonly used fiber layout configurations exposed to real a marine environment, relative to the initial value calculated for dry coupons.
- In this research, an experimental and numerical analysis was conducted to verify a suitable repair technique of a failed pressure vessel with a composite material patch in order to restore the vessel's functionality. The results of the analysis clearly indicated that the repair with the composite patch enabled the structure to successfully withstand the working and test pressure. Since this relatively simple method of structural repair proved to be valid, new areas of application in the marine transport sector (and not solely to this sector) are foreseeable.
- The entirety of the findings obtained in this research serves as a basis for a proposal to classification societies to revise design procedures for marine structures exposed to a real marine environment in order to include the effects of degradation of mechanical properties caused by living organisms. Although

existing rules and regulations (for example Det Norske Veritas (DNV) regulations) do acknowledge composites as structural materials, a paradigm shift is needed in ship construction as the early stages of design open up more opportunities for composite materials compared to the traditionally used materials of steel and aluminum. Standards often recommend “documenting test results” in order to determine the behavior of the composite material and recommend using the same design procedures as for steel, aluminum or wood, thus emphasizing the lack of reliable analytical or numerical models in this field or research. Structural design standards issued by classification societies progressively introduce guideline for composite elements for specific structural elements (for example composite tendons for offshore structures), assuming that “material properties such as strength and stiffness are normally distributed”(DNV-OS-C501, 2010), which is not the case for all fiber layout configurations. The same standards state that the “stacking sequence shall be clearly identified”, that “the orientation of non-homogenous or anisotropic materials shall be clearly specified on the materials level and the structural level” and that the “laminates shall be specified in a way that they can be described by a sequence of stacked orthotropic plies”. The standards also assume that “the UD ply has linear elastic properties” and “the cross-ply is bi-linear in tension and in compression”. All this results in an obligation to treat a composite laminate as a stack of orthotropic plies, with no mention whatsoever of environmentally influenced material properties degradation. When defining mechanical strength properties, the classification standard requires the usage of a “characteristic strength” value that is to be obtained by experimental measurements for long term static, cyclic and high rate loads, again not taking into consideration the effect of long-time exposure to the real marine environment identified as significant by this research. The standards specify that “The term environment designates in this standard the surroundings that impose no direct load on the product, e.g. ambient temperature, moisture or chemicals”. The findings of this research can be integrated into the definitions of the ultimate strength values by introducing the degradation of material properties caused by coupled effects of moisture intake and marine dwelling organisms attachment and embedding in the composite material.

4.2 Future work

The research has indicated possible future work and expansion topics which include:

- The manufacturing process plays a significant role in resulting composite part or structure mechanical properties. The polyester coupons were fabricated by the hand-layup process, whilst the epoxy coupons were produced by vacuum-assisted infusion. One research direction that could improve the proposed material behavior model would be to integrate the various composite material manufacturing processes that have negative effects on the material properties.
- Surface attachment and the matrix embedding mechanisms of sea dwelling organism's (invertebrate and microorganisms alike) at the micro level is still not fully known. The activity of these organisms directly led to the degradation of the composite material mechanical properties. There is currently ongoing microbiological research trying to determine whether the aforementioned organisms are eating or drilling their way into the material. These research results would be used to further develop the mechanical degradation model.
- The effect of the real marine environment on the composite data set collected in this research was done on a certain number of coupons submerged in a single location of the sea. Further experiments of the same kind performed under different environmental conditions and locations, could significantly increase the accuracy of the model and certainty of its application.
- There is, the possibility to further develop the numerical method that would incorporate continuous UTS decay, all of the aspects of the stochastic nature of the marine environment, increasing the accuracy of the prediction.

Chapter 5

Summary of Papers

A Effect of Time-Real Marine Environment Exposure on the Mechanical Behavior of FRP Composites

Fiber reinforced polymer (FRP) composites coupons were exposed to real sea environment to assess the influence on the mechanical behavior of composite materials used in the construction of marine structures. Real-life sea environment conditions were opted for instead of the more common simulated and laboratory versions of seawater in the attempt to obtain more realistic structural modeling environmental input design parameters for marine structures. Exposure was performed over prolonged time span instead of the usual accelerated tests. Epoxy and polyester resins, reinforced with glass fibers in three fiber layout configurations, were used to manufacture standardized tensile testing coupons. Mass changes due to seawater absorption, microorganism growth, changes in tensile strength (standard tensile tests), and surface morphology of the coupons were evaluated after 6- and 12-month long periods of submersion in the sea in the Rijeka bay, Croatia. All specimens showed mass increase due to water absorption and growth of attached algae and sea microorganisms. Various levels of reduction in tensile strength, depending on the fiber layout configurations, were observed. Significant changes in the matrix material structure were noticed, effectively producing “voids”. Based on these results, sustainability of FRP composites in marine environment is addressed and discussed.

Vizentin, G.; Glujić, D.; Špada, V., 2021. Effect of Time-Real Marine Environment Exposure on the Mechanical Behavior of FRP Composites. Sustainability, 13, 9934.

<https://doi.org/10.3390/su13179934>

B Marine Environment Induced Failure of FRP Composites Used in Maritime Transport

Fiber reinforced polymer (FRP) composites are being extensively considered for construction of ships and marine structures. Due to harsh environmental operational conditions, failure prediction of such structures is an imperative in this industry sector. This paper presents the final results of a 2-year research of real marine environment induced changes of mechanical properties in FRP composites.

Realistic environmental input parameters for structural modeling of marine structures are crucial and can be obtained by conducting tests in real sea environment for prolonged periods, as opposed to usual accelerated laboratory experiments. In this research, samples of epoxy/glass and polyester/glass with various fiber layout configurations have been submerged under the sea for periods of 6, 12 and 24 months. An analysis of mass changes, marine microbiology growth, tensile strength and morphological structures of the coupons was performed and compared with samples exposed to room environment.

All samples exhibited an increase in mass due to seawater absorption and microorganism growth in the organic resins (matrix). The tensile strength loss variation through the periods of submersion showed a correlation with the fiber layout configuration. The results of optical and scanning electron microscopical investigation indicated significant matrix morphological changes primarily due to salt crystal formation and the impact of sea microorganisms embedding in and attaching to the resin.

The outcome of this research will be the basis for a set of realistic input parameters for a failure analysis numerical tool currently in development that can be applied for life-time behavior predictions of marine structures.

*Vizentin, G.; Vukelic, G.; 2022. Marine Environment Induced Failure of FRP Composites Used in Maritime Transport. Engineering Failure Analysis, 137.
<https://doi.org/10.1016/j.engfailanal.2022.106258>*

C Prediction of FRP Composites Properties Deterioration Induced by Marine Environment

A model for prediction of fatigue life degradation of fiber reinforced (FRP) composite material exposed for prolonged periods to real marine environment is proposed. The data collected during previous phases of a more comprehensive research of real marine environment induced changes of mechanical properties in FRP composites was used to assess the influence of these changes on the durability characteristic of composites. Attention has been given to classification societies design and exploitation rules in this matter. The need for modification of the composite material S-N curves obtaining process, considering the marine environment influence has been considered. Regression analysis of the experimental data has been conducted, resulting in a mathematical strength degradation in time model. The regression analysis has shown an acceptable correlation value. S-N curves for E-glass/polyester composite with three different fiber layout configurations have been evaluated and modified in order to encompass the findings of the research.

*Vizentin, G.; Vukelic, G.; 2022. Prediction of FRP Composites Properties Deterioration Induced by Marine Environment. Journal of Marine Science and Engineering, 10, 510.
<https://doi.org/10.3390/jmse10040510>*

D Composite wrap repair of a failed pressure vessel— Experimental and numerical analysis

This experimental and numerical study deals with the failure of two steel pressure vessels that failed during hydrostatic test at a pressure lower than test pressure. Failure was noticed because of pressure drop and fluid leakage during the test and, later, by observing through-wall cracks that formed on the vessels. Experimentally, visual and ultrasonic non-destructive testing was performed to check the vessel for possible cracks and to measure wall thickness. Microscopy was employed to inspect the existing cracks and determine their dimensions. Results revealed pitting corrosion at the bottom part of the vessel to be the cause of the cracks. Numerical analysis was performed to assess the possibility of retaining the functionality of the vessel by using composite patch repair procedure. Results proved that repaired vessel can retain the pressure bearing capacity and numerically obtained results were confirmed by experimental investigation on the similar vessels. As a conclusion, some recommendations are given to avoid future failures of such pressure vessels.

Vukelic, G.; Vizentin G.; 2021. Composite wrap repair of a failed pressure vessel—Experimental and numerical analysis. Thin-Walled Structures, 169.
<https://doi.org/10.1016/j.tws.2021.108488>

Bibliography

Abioye, O.P., Loto, C.A., Fayomi, O.S.I., 2019. Evaluation of Anti-biofouling Progresses in Marine Application. *J. Bio- Tribo-Corrosion* 5, 22. <https://doi.org/10.1007/s40735-018-0213-5>

Afshar, A., 2017. Synergistic effects of marine environments and flexural fatigue on carbon fiber–vinyl ester composites protected by gelcoat. *J. Compos. Mater.* 51, 3711–3717. <https://doi.org/10.1177/0021998317691586>

Afshar, A., Mihut, D., Chen, P., 2020. Effects of environmental exposures on carbon fiber epoxy composites protected by metallic thin films. *J. Compos. Mater.* 54, 167–177. <https://doi.org/10.1177/0021998319859051>

Alam, P., Robert, C., Ó Brádaigh, C.M., 2018. Tidal turbine blade composites - A review on the effects of hygrothermal aging on the properties of CFRP. *Compos. Part B Eng.* 149, 248–259. <https://doi.org/10.1016/j.compositesb.2018.05.003>

Ali Ghaffari, M., Hosseini-Toudeshky, H., 2013. Fatigue Crack Propagation Analysis of Repaired Pipes With Composite Patch Under Cyclic Pressure. *J. Press. Vessel Technol.* 135. <https://doi.org/10.1115/1.4023568>

Alizadeh, E., Dehestani, M., 2018. Analytical and numerical fracture analysis of pressure vessel containing wall crack and reinforcement with CFRP laminates. *Thin-Walled Struct.* 127, 210–220. <https://doi.org/10.1016/j.tws.2018.02.009>

Ansys inc., 2022. ACP User's Guide.

Ansys inc., 2021a. Element Reference.

Ansys inc., 2021b. Theory Reference Ansys.

Ayaz, Y., Çitil, Ş., Şahan, M.F., 2016. Repair of small damages in steel pipes with composite patches. *Materwiss. Werksttech.* 47, 503–511. <https://doi.org/10.1002/mawe.201600526>

Barbero, E.J., 2017. Introduction to Composite Materials Design, Third Edition. CRC Press. <https://doi.org/10.1201/9781315296494>

Bazli, M., Ashrafi, H., Oskouei, A.V., 2016. Effect of harsh environments on mechanical properties of GFRP pultruded profiles. *Compos. Part B Eng.* 99, 203–215. <https://doi.org/10.1016/j.compositesb.2016.06.019>

Belingardi, G., Paolino, D.S., Koricho, E.G., 2011. Investigation of influence of tab types on tensile strength of E-glass/epoxy fiber einforced composite materials. *Procedia Eng.* 10, 3279–3284. <https://doi.org/10.1016/j.proeng.2011.04.541>

Bian, L., Xiao, J., Zeng, J., Xing, S., 2012. Effects of seawater immersion on water absorption and mechanical properties of GFRP composites. *J. Compos. Mater.* 46, 3151–3162. <https://doi.org/10.1177/0021998312436992>

Bond, D.A., 2005. Moisture Diffusion in a Fiber-reinforced Composite: Part I – Non-Fickian Transport and the Effect of Fiber Spatial Distribution. *J. Compos. Mater.* 39, 2113–2141. <https://doi.org/10.1177/0021998305052030>

Brčić, M., Krščanski, S., Brnić, J., 2021. Rotating Bending Fatigue Analysis of Printed Specimens from Assorted Polymer Materials. *Polymers (Basel)*. 13, 1020.

<https://doi.org/10.3390/polym13071020>

Burhan, I., Kim, H., 2018. S-N Curve Models for Composite Materials Characterisation: An Evaluative Review. *J. Compos. Sci.* 2, 38. <https://doi.org/10.3390/jcs2030038>

Caliri, M.F., Ferreira, A.J.M., Tita, V., 2016. A review on plate and shell theories for laminated and sandwich structures highlighting the Finite Element Method. *Compos. Struct.* 156, 63–77. <https://doi.org/10.1016/j.compstruct.2016.02.036>

Chalmers, D.W., 1994. The Potential for the use of composite materials in marine structures. *Mar. Struct.* 7, 441–456. [https://doi.org/10.1016/0951-8339\(94\)90034-5](https://doi.org/10.1016/0951-8339(94)90034-5)

Chandrasekaran, S., 2015. *Advanced Marine Structures*, Advanced Marine Structures. CRC Press. <https://doi.org/10.1201/b18792>

Chen, D., Yan, R., Lu, X., 2021. Mechanical properties analysis of the naval ship similar model with an integrated sandwich composite superstructure. *Ocean Eng.* 232, 109101. <https://doi.org/10.1016/j.oceaneng.2021.109101>

Chen, N.-Z., Guedes Soares, C., 2008. Spectral stochastic finite element analysis for laminated composite plates. *Comput. Methods Appl. Mech. Eng.* 197, 4830–4839. <https://doi.org/10.1016/j.cma.2008.07.003>

Choi, Y.Y., Lee, S.H., Park, J.-C., Choi, D.J., Yoon, Y.S., 2019. The impact of corrosion on marine vapour recovery systems by VOC generated from ships. *Int. J. Nav. Archit. Ocean Eng.* 11, 52–58. <https://doi.org/10.1016/j.ijnaoe.2018.01.002>

Davies, P., Germain, G., Gaurier, B., Boisseau, A., Perreux, D., 2013. Evaluation of the durability of composite tidal turbine blades. *Philos. Trans. R. Soc. A Math. Phys. Eng. Sci.* 371, 20120187. <https://doi.org/10.1098/rsta.2012.0187>

Davies, P., Rajapakse, Y.D.S. (Eds.), 2018. *Durability of Composites in a Marine Environment 2, Solid Mechanics and Its Applications*. Springer International Publishing, Cham. <https://doi.org/10.1007/978-3-319-65145-3>

Davies, P., Rajapakse, Y.D.S. (Eds.), 2014. *Durability of Composites in a Marine Environment, Solid Mechanics and Its Applications*. Springer Netherlands, Dordrecht. <https://doi.org/10.1007/978-94-007-7417-9>

Diez de Ulzurrun, I., López, F., Herreros, M.A., Suárez, J.C., 2007. Tests of deck-to-hull adhesive joints in GFRP boats. *Eng. Fail. Anal.* 14, 310–320. <https://doi.org/10.1016/j.engfailanal.2006.02.012>

Djehader, D., Redjel, B., 2017. Fatigue of glass-polyester composite immersed in water. *J. Eng. Sci. Technol.* 12, 1204–1215.

DNV-OS-C501, 2010. *Composite Components*. Det Nor. Verit. 119–134.

DNV, 2021. Wave loads. www.dnv.com.

DNV, 2014. *Environmental Conditions and Environmental Loads*. <http://www.dnv.com>.

DNV GL AS, 2017. *DNVGL-ST-C501 Composite components*.

Dong, H., Li, Z., Wang, J., Karihaloo, B.L., 2016. A new fatigue failure theory for multidirectional fiber-reinforced composite laminates with arbitrary stacking sequence. *Int. J. Fatigue* 87, 294–300. <https://doi.org/10.1016/j.ijfatigue.2016.02.012>

- Echtermeyer, A.T., McGeorge, D., Grave, J.H.L., Weitzenböck, J., 2014. Bonded patch repairs for metallic structures – A new recommended practice. *J. Reinf. Plast. Compos.* 33, 579–585. <https://doi.org/10.1177/0731684413510754>
- Eslami, Shahram, Honarbakhsh-Raouf, A., Eslami, Shiva, 2015. Effects of moisture absorption on degradation of E-glass fiber reinforced Vinyl Ester composite pipes and modelling of transient moisture diffusion using finite element analysis. *Corros. Sci.* 90, 168–175. <https://doi.org/10.1016/j.corsci.2014.10.009>
- Fang, H., Mao, Y., Liu, W., Zhu, L., Zhang, B., 2016. Manufacturing and evaluation of Large-scale Composite Bumper System for bridge pier protection against ship collision. *Compos. Struct.* 158, 187–198. <https://doi.org/10.1016/j.compstruct.2016.09.013>
- Gagani, A.I., Krauklis, A.E., Echtermeyer, A.T., 2018. Orthotropic fluid diffusion in composite marine structures. Experimental procedure, analytical and numerical modelling of plates, rods and pipes. *Compos. Part A Appl. Sci. Manuf.* 115, 196–205. <https://doi.org/10.1016/j.compositesa.2018.09.026>
- George, J.M., Kimiaei, M., Elchalakani, M., Fawzia, S., 2021. Experimental and numerical investigation of underwater composite repair with fibre reinforced polymers in corroded tubular offshore structural members under concentric and eccentric axial loads. *Eng. Struct.* 227, 111402. <https://doi.org/10.1016/j.engstruct.2020.111402>
- Gljušić, M., Franulović, M., Lanc, D., Božić, Ž., 2021. Digital image correlation of additively manufactured CFRTP composite systems in static tensile testing. *Procedia Struct. Integr.* 31, 116–121. <https://doi.org/10.1016/j.prostr.2021.03.019>
- Gonabadi, H., Oila, A., Yadav, A., Bull, S., 2021. Structural performance of composite tidal turbine blades. *Compos. Struct.* 278, 114679. <https://doi.org/10.1016/j.compstruct.2021.114679>
- Grabovac, I., Bartholomeusz, R.A., Baker, A.A., 1993. Composite reinforcement of a ship superstructure—project overview. *Composites* 24, 501–509. [https://doi.org/10.1016/0010-4361\(93\)90020-9](https://doi.org/10.1016/0010-4361(93)90020-9)
- Grace, L.R., 2016. Projecting long-term non-Fickian diffusion behavior in polymeric composites based on short-term data: a 5-year validation study. *J. Mater. Sci.* 51, 845–853. <https://doi.org/10.1007/s10853-015-9407-0>
- Graham-Jones, J., Summerscales, J., 2015. Marine Applications of Advanced Fibre-Reinforced Composites, Marine Applications of Advanced Fibre-Reinforced Composites. Elsevier. <https://doi.org/10.1016/C2013-0-16504-X>
- Greene, E., 1999. *Marine Composites*, 2nd ed. Eric Greene Associates, Inc.
- Grogan, D., Flanagan, M., Walls, M., Leen, S., Doyle, A., Harrison, N., Mamalis, D., Goggins, J., 2018. Influence of microstructural defects and hydrostatic pressure on water absorption in composite materials for tidal energy. *J. Compos. Mater.* 52, 2899–2917. <https://doi.org/10.1177/0021998318755428>
- Hinton, M.J., Kaddour, A.S., Soden, P.D. (Eds.), 2004. *Failure Criteria in Fibre-Reinforced-Polymer Composites*. Elsevier. <https://doi.org/10.1016/B978-0-080-44475-8.X5000-8>
- Institute of Oceanography and Fisheries, 2012. Početna procjena stanja i opterećenja morskog okoliša hrvatskog dijela Jadrana. Split, Croatia.

INTERNATIONAL STANDARD, 2020. ISO 527 Plastics - Determination of tensile properties.

ISO 2818, 2018. Plastics - Preparation of test specimens by machining.

Joliff, Y., Belec, L., Chailan, J.F., 2013. Modified water diffusion kinetics in an unidirectional glass/fibre composite due to the interphase area: Experimental, analytical and numerical approach. *Compos. Struct.* 97, 296–303. <https://doi.org/10.1016/j.compstruct.2012.09.044>

Joliff, Y., Rekik, W., Belec, L., Chailan, J.F., 2014. Study of the moisture/stress effects on glass fibre/epoxy composite and the impact of the interphase area. *Compos. Struct.* 108, 876–885. <https://doi.org/10.1016/j.compstruct.2013.10.001>

Karbhari, V.M. (Ed.), 2015. *Rehabilitation of Pipelines Using Fiber-reinforced Polymer (FRP) Composites*. Elsevier. <https://doi.org/10.1016/C2013-0-16345-3>

Kastratović, G., Grbović, A., Sedmak, A., Božić, Ž., Sedmak, S., 2021. Composite material selection for aircraft structures based on experimental and numerical evaluation of mechanical properties. *Procedia Struct. Integr.* 31, 127–133. <https://doi.org/10.1016/j.prostr.2021.03.021>

Kim, D.-U., Seo, H.-S., Jang, H.-Y., 2021. Study on Mechanical Bearing Strength and Failure Modes of Composite Materials for Marine Structures. *J. Mar. Sci. Eng.* 9, 726. <https://doi.org/10.3390/jmse9070726>

Kim, H.S., Huang, S., 2021. S-N Curve Characterisation for Composite Materials and Prediction of Remaining Fatigue Life Using Damage Function. *J. Compos. Sci.* 5, 76. <https://doi.org/10.3390/jcs5030076>

Kovač, N., Ivošević, Š., Vastag, G., Vukelić, G., Rudolf, R., 2021. Statistical Approach to the Analysis of the Corrosive Behaviour of NiTi Alloys under the Influence of Different Seawater Environments. *Appl. Sci.* 11, 8825. <https://doi.org/10.3390/app11198825>

Lin, Y., Yan, J., Wang, Z., Zou, C., 2021. Effects of steel fibers on failure mechanism of S-UHPC composite beams applied in the Arctic offshore structure. *Ocean Eng.* 234, 109302. <https://doi.org/10.1016/j.oceaneng.2021.109302>

Litwin, W., 2019. Marine Propeller Shaft Bearings under Low-Speed Conditions: Water vs. Oil Lubrication. *Tribol. Trans.* 62, 839–849. <https://doi.org/10.1080/10402004.2019.1625991>

Lukács, J., Koncsik, Z., Chován, P., 2021. Integrity reconstruction of damaged transporting pipelines applying fiber reinforced polymer composite wraps. *Procedia Struct. Integr.* 31, 51–57. <https://doi.org/10.1016/j.prostr.2021.03.009>

Mathijssen, D., 2016. Now is the time to make the change from metal to composites in naval shipbuilding. *Reinf. Plast.* 60, 289–293. <https://doi.org/10.1016/j.repl.2016.08.003>

Milenkovic, S., Slavkovic, V., Fragassa, C., Grujovic, N., Palic, N., Zivic, F., 2021. Effect of the raster orientation on strength of the continuous fiber reinforced PVDF/PLA composites, fabricated by hand-layup and fused deposition modeling. *Compos. Struct.* 270, 114063. <https://doi.org/10.1016/j.compstruct.2021.114063>

Mouritz, A., Gellert, E., Burchill, P., Challis, K., 2001. Review of advanced composite structures for naval ships and submarines. *Compos. Struct.* 53, 21–42.

[https://doi.org/10.1016/S0263-8223\(00\)00175-6](https://doi.org/10.1016/S0263-8223(00)00175-6)

Mulcahy, N.L., Prusty, B.G., Gardiner, C.P., 2010. Hydroelastic tailoring of flexible composite propellers. *Ships Offshore Struct.* 5, 359–370. <https://doi.org/10.1080/17445302.2010.481139>

Muthukumar, T., Aravinthan, A., Lakshmi, K., Venkatesan, R., Vedaprakash, L., Doble, M., 2011. Fouling and stability of polymers and composites in marine environment. *Int. Biodeterior. Biodegradation* 65, 276–284. <https://doi.org/10.1016/j.ibiod.2010.11.012>

Neşer, G., 2017. Polymer Based Composites in Marine Use: History and Future Trends. *Procedia Eng.* 194, 19–24. <https://doi.org/10.1016/j.proeng.2017.08.111>

Neuschwander, K., Moll, J., Memmolo, V., Schmidt, M., Bücker, M., 2019. Simultaneous load and structural monitoring of a carbon fiber rudder stock: Experimental results from a quasi-static tensile test. *J. Intell. Mater. Syst. Struct.* 30, 272–282. <https://doi.org/10.1177/1045389X18806392>

Peret, T., Clement, A., Freour, S., Jacquemin, F., 2019. Homogenization of Fickian and non-Fickian water diffusion in composites reinforced by hydrophobic long fibers: Application to the determination of transverse diffusivity. *Compos. Struct.* 226, 111191. <https://doi.org/10.1016/j.compstruct.2019.111191>

Peret, T., Clement, A., Freour, S., Jacquemin, F., 2017. Effect of mechanical states on water diffusion based on the free volume theory: Numerical study of polymers and laminates used in marine application. *Compos. Part B Eng.* 118, 54–66. <https://doi.org/10.1016/j.compositesb.2017.02.046>

Peret, T., Clement, A., Freour, S., Jacquemin, F., 2014. Numerical transient hygro-elastic analyses of reinforced Fickian and non-Fickian polymers. *Compos. Struct.* 116, 395–403. <https://doi.org/10.1016/j.compstruct.2014.05.026>

Prasad, A.S., Ramakrishna, S., Madhavi, M., 2018. Experimental Investigations on Static and Dynamic Parameters of Steel and Composite Propeller Shafts with an Integrated Metallic Joints. *Mater. Today Proc.* 5, 26925–26933. <https://doi.org/10.1016/j.matpr.2018.08.180>

Rahimi, N., Rahim, M.A., Hussain, A.K., Mahmud, J., 2012. Evaluation of failure criteria for composite plates under tension, in: 2012 IEEE Symposium on Humanities, Science and Engineering Research. IEEE, pp. 849–854. <https://doi.org/10.1109/SHUSER.2012.6269001>

Rocha, I.B.C.M., Raijmaekers, S., van der Meer, F.P., Nijssen, R.P.L., Fischer, H.R., Sluys, L.J., 2017. Combined experimental/numerical investigation of directional moisture diffusion in glass/epoxy composites. *Compos. Sci. Technol.* 151, 16–24. <https://doi.org/10.1016/j.compscitech.2017.08.002>

Rubino, F., Nisticò, A., Tucci, F., Carlone, P., 2020. Marine Application of Fiber Reinforced Composites: A Review. *J. Mar. Sci. Eng.* 8, 26. <https://doi.org/10.3390/jmse8010026>

Saeed, N., Ronagh, H., Virk, A., 2014. Composite repair of pipelines, considering the effect of live pressure-analytical and numerical models with respect to ISO/TS 24817 and ASME PCC-2. *Compos. Part B Eng.* 58, 605–610. <https://doi.org/10.1016/j.compositesb.2013.10.035>

- Saravanan, M., Kumar, D.B., 2021. A review on navy ship parts by advanced composite material. *Mater. Today Proc.* 45, 6072–6077. <https://doi.org/10.1016/j.matpr.2020.10.074>
- Setvati, M.R., Shafiq, N., Mustaffa, Z., Syed, Z.I., 2014. A review on composite materials for offshore structures, in: *Proceedings of the International Conference on Offshore Mechanics and Arctic Engineering - OMAE*. p. 8. <https://doi.org/10.1115/OMAEE2014-23542>
- Silvera, A., Vazquez, J., Vinssac, V., 2011. Strain analysis of a glass-fibre-reinforced polyester under dynamic loads. *Spanish J. Agric. Res.* 9, 49. <https://doi.org/10.5424/sjar/20110901-444-10>
- Sousa, J., Marques, J., Garcia, M., Infante, V., Amaral, P., 2020. Mechanical characterization of sandwich composites with embedded sensors. *Eng. Fail. Anal.* 117, 104765. <https://doi.org/10.1016/j.engfailanal.2020.104765>
- Tamboura, S., Abdessalem, A., Fitoussi, J., Ben Daly, H., Tcharkhtchi, A., 2022. On the mechanical properties and damage mechanisms of short fibers reinforced composite submitted to hydrothermal aging: Application to sheet molding compound composite. *Eng. Fail. Anal.* 131, 105806. <https://doi.org/10.1016/j.engfailanal.2021.105806>
- Telegdi, J., Trif, L., Románszki, L., 2016. Smart anti-biofouling composite coatings for naval applications, in: *Smart Composite Coatings and Membranes*. Elsevier, pp. 123–155. <https://doi.org/10.1016/B978-1-78242-283-9.00005-1>
- Tomasz, M., Szymon, D., Bartosz, B., Joanna, W., Paweł, Z., Grzegorz, L., 2022. Flexural and compressive residual strength of composite bars subjected to harsh environments. *Eng. Fail. Anal.* 133, 105958. <https://doi.org/10.1016/j.engfailanal.2021.105958>
- Vázquez, J., Silvera, A., Arias, F., Soria, E., 1998. Fatigue properties of a glass-fibre-reinforced polyester material used in wind turbine blades. *J. Strain Anal. Eng. Des.* 33, 183–193. <https://doi.org/10.1243/0309324981512904>
- Venkatesan, K., Ramanathan, K., Vijayanandh, R., Selvaraj, S., Raj Kumar, G., Senthil Kumar, M., 2020. Comparative structural analysis of advanced multi-layer composite materials. *Mater. Today Proc.* 27, 2673–2687. <https://doi.org/10.1016/j.matpr.2019.11.247>
- Vizentin, G., Glujić, D., Špada, V., 2021. Effect of Time-Real Marine Environment Exposure on the Mechanical Behavior of FRP Composites. *Sustainability* 13, 9934. <https://doi.org/10.3390/su13179934>
- Vizentin, G., Vukelic, G., 2022a. Prediction of the Deterioration of FRP Composite Properties Induced by Marine Environments. *J. Mar. Sci. Eng.* 10, 510. <https://doi.org/10.3390/jmse10040510>
- Vizentin, G., Vukelic, G., 2022b. Marine environment induced failure of FRP composites used in maritime transport. *Eng. Fail. Anal.* 137, 106258. <https://doi.org/10.1016/j.engfailanal.2022.106258>
- Vizentin, G., Vukelic, G., 2019. Degradation and damage of composite materials in marine environment. *Medziagotyra*. <https://doi.org/10.5755/j01.ms.26.3.22950>
- Vukelic, G., Vizentin, G., Ivosevic, S., 2021. Tensile strength behaviour of steel plates

- with corrosion-induced geometrical deteriorations. *Ships Offshore Struct.* 1–9. <https://doi.org/10.1080/17445302.2021.2006969>
- Wang, C., Ge, S., Jaworski, J.W., Liu, L., Jia, Z., 2019. Effects of Different Design Parameters on the Vortex Induced Vibration of FRP Composite Risers Using Grey Relational Analysis. *J. Mar. Sci. Eng.* 7, 231. <https://doi.org/10.3390/jmse7070231>
- Xie, H., Ren, H., Qu, S., Tang, H., 2018. Numerical and experimental study on hydroelasticity in water-entry problem of a composite ship-hull structure. *Compos. Struct.* 201, 942–957. <https://doi.org/10.1016/j.compstruct.2018.06.030>
- Yang, Z., Cao, Y., Liu, J., 2021. A Buckling Analysis and Optimization Method for a Variable Stiffness Cylindrical Pressure Shell of AUV. *J. Mar. Sci. Eng.* 9, 637. <https://doi.org/10.3390/jmse9060637>
- Yasar, A., Kacar, İ., Keskin, A., 2014. Tensile and Fatigue Behavior of Glass Fiber-Reinforced (MAT-8)/Polyester Automotive Composite. *Arab. J. Sci. Eng.* 39, 3191–3197. <https://doi.org/10.1007/s13369-013-0897-2>
- Yoon, S.W., Park, C.W., 2021. Laminated design for the application of composite materials for ship radar mast. *Int. J. Mod. Phys. B* 35, 2140039. <https://doi.org/10.1142/S0217979221400397>
- You, J.H., 2009a. Triple-scale failure estimation for a composite-reinforced structure based on integrated modeling approaches. Part 1: Microscopic scale analysis. *Eng. Fract. Mech.* 76, 1425–1436. <https://doi.org/10.1016/j.engfracmech.2008.12.014>
- You, J.H., 2009b. Triple-scale failure estimation for a composite-reinforced structure based on integrated modeling approaches. Part 2: Meso- and macroscopic scale analysis. *Eng. Fract. Mech.* 76, 1437–1449. <https://doi.org/10.1016/j.engfracmech.2008.10.017>
- Young, Y.L., Baker, J.W., Motley, M.R., 2010. Reliability-based design and optimization of adaptive marine structures. *Compos. Struct.* 92, 244–253. <https://doi.org/10.1016/j.compstruct.2009.07.024>
- Zayed, A., Garbatov, Y., Guedes Soares, C., 2018. Corrosion degradation of ship hull steel plates accounting for local environmental conditions. *Ocean Eng.* 163, 299–306. <https://doi.org/10.1016/j.oceaneng.2018.05.047>
- Zhang, L.W., Xiao, L.N., 2017. Mechanical behavior of laminated CNT-reinforced composite skew plates subjected to dynamic loading. *Compos. Part B Eng.* 122, 219–230. <https://doi.org/10.1016/j.compositesb.2017.03.041>
- Zhao, X., Wang, X., Wu, Z., Zhu, Z., 2016. Fatigue behavior and failure mechanism of basalt FRP composites under long-term cyclic loads. *Int. J. Fatigue* 88, 58–67. <https://doi.org/10.1016/j.ijfatigue.2016.03.004>

List of figures

Figure I.1 Composite ship hull section (source: http://www.fibreship.eu/fibreship-2nd-public-workshop/	2
Figure I.2 Coupon dimensions	14
Figure I.3 Fiber layout configurations: a) UD0°, b) (0/90)s, c) (0/±45/90)s coupons. 14	14
Figure I.4 Coupons with tabs before submersion	15
Figure I.5 Stainless steel fixture 3D CAD model	16
Figure I.6 Coupons in frame after 6 months of submersion	17
Figure I.7 Coupon on completion of the tensile test	19
Figure I.8 ANSYS SHELL181 element geometry (Ansys inc., 2021a)	22

List of tables

Table 1 Resin systems basic mechanical properties.....	15
--	----

List of publications

- Books and book chapters:
 - Vukelić, G.; Vizentin, G., 2017. Common Case Studies of Marine Structural Failures. // Failure Analysis and Prevention / Aidy Ali (ed.). Rijeka, Intech, pp. 135-151, DOI: 10.5772/intechopen.72789

- Journal articles
 - Vizentin, Goran; Vukelic, Goran. Prediction of the Deterioration of FRP Composite Properties Induced by Marine Environments. // Journal of marine Science and Engineering (2022). DOI: 10.3390/jmse10040510 (international peer review)
 - Vizentin, Goran; Vukelic, Goran. Marine Environment Induced Failure of FRP Composites Used in Maritime Transport. // Engineering Failure Analysis, 137 (2022). DOI: 10.1016/j.engfailanal.2022.106258 (international peer review)
 - Vukelić, Goran; Vizentin, Goran; Ivošević, Špiro; Božić, Željko. Analysis of Prolonged Marine Exposure on Properties of AH36 Steel. // Engineering failure analysis (2022) DOI: 10.1016/j.engfailanal.2022.106132 (international peer review, online first)
 - Vukelić, Goran; Vizentin, Goran; Ivošević, Špiro. Tensile strength behaviour of steel plates with corrosion-induced geometrical deteriorations. // Ships and Offshore Structures (2021) DOI: 10.1080/17445302.2021.2006969 (international peer review, online first)
 - Vukelić, Goran; Vizentin, Goran; Frančić, Vlado, Prospects for use of extended reality technology for ship passenger evacuation simulation. // Pomorstvo:

scientific journal of maritime research, 35 (2021), 49-56
doi:10.31217/p.35.1.6 (peer review, review, scholarly)

- Vukelić, Goran; Vizentin, Goran; Brnić, Josip; Brčić, Marino, Sedmak, Florian. Long-Term Marine Environment Exposure Effect on Butt-Welded Shipbuilding Steel. // Journal of marine science and engineering, 9 (2021), 5; 491, 12 DOI:org/10.3390/jmse9050491 (international peer review, article, scholarly)
- Vukelić, Goran; Vizentin, Goran; Bakhtiari, Reza. Failure analysis of a steel pressure vessel with a composite wrap repair proposal. // International journal of pressure vessels and piping, 193 (2021), 104476, 13 DOI: d10.1016/j.ijpvp.2021.104476 (international peer review, article, scholarly)
- Vukelić, Goran; Vizentin, Goran; Perić Hadžić, Ana Comparative SWOT analysis of virtual reality and augmented reality ship passenger evacuation technologies. // Scientific journals of the Maritime University of Szczecin, 68 (2021), 140; 99-107 (international peer review, article, scholarly)
- Vukelić, Goran; Vizentin, Goran. Composite wrap repair of a failed pressure vessel - Experimental and numerical analysis. // Thin-walled structures, 169 (2021), 108488, 9 DOI: 10.1016/j.tws.2021.108488 (international peer review, article, scholarly)
- Vizentin, Goran; Glujić, Darko; Špada, Vedrana. Effect of Time-Real Marine Environment Exposure on the Mechanical Behavior of FRP Composites. // Sustainability, 13 (2021), 17; 1307929, 20 doi:10.3390/su13179934 (international peer review, article, scholarly)
- Vukelić, Goran; Vizentin, Goran; Božić, Željko; Rukavina, Luka. Failure analysis of a ruptured compressor pressure vessel. // Procedia structural integrity, 31 (2021), 28-32 DOI: 10.1016/j.prostr.2021.03.006 (international peer review, article, scholarly)
- Vukelić, Goran; Pastorčić, Darko; Vizentin, Goran; Božić, Željko. Failure investigation of a crane gear damage. // Engineering failure analysis, 115

- (2020), 104613, 9 DOI: 10.1016/j.engfailanal.2020.104613 (international peer review, article, scholarly)
- Vizentin, Goran; Vukelić, Goran. Degradation and damage of composite materials in marine environment. // Materials Science-Medziagotyra, 26 (2020), 3; 337-342 DOI: 10.5755/j01.ms.26.3.22950 (international peer review, article, scholarly)
 - Vizentin, Goran; Vukelić, Goran; Murawski, Lech; Recho, Naman; Orović, Josip. Marine Propulsion System Failures - A Review. // Journal of marine science and engineering, 8 (2020), 9; 662, 13 DOI: 10.3390/jmse8090662 (international peer review, article, scholarly)
 - Vukelić, Goran; Vizentin, Goran; Masar, Aleksandra. Hydraulic torque wrench adapter failure analysis. // Engineering Failure Analysis, 96 (2019), 530-537 DOI: 10.1016/j.engfailanal.2018.11.010 (international peer review, article, scholarly)
 - Vukelić, Goran; Vizentin, Goran. Damage-Induced Stresses and Remaining Service Life Predictions of Wire Ropes. // Applied Sciences-Basel, 7 (2017), 1; 107-113 DOI: 10.3390/app7010107 (international peer review, article, scholarly)
 - Vizentin, Goran; Vukelić, Goran; Srok, Mateo. Common failures of ship propulsion shafts. // Pomorstvo: scientific journal of maritime research, 31 (2017), 2; 85-90 DOI: 10.31217/p.31.2.1 (peer review, review, scholarly)
 - Turkalj, Goran; Brnić, Josip; Vizentin, Goran; Lanc, Domagoj. Numerical simulation of instability behaviour of thin-walled frames with flexible connections. // Materials Science & Engineering A - Structural Materials Properties Microstructure and Processing, 499 (2009), 1-2 Special Issue; 74-77 DOI: 10.1016/j.msea.2007.10.117 (international peer review, article, scholarly)
 - Turkalj, Goran; Vizentin, Goran; Lanc, Domagoj. Finite element modelling of the behaviour of connections in the stability analysis of thin-walled beam-type

structures. // Transactions of FAMENA, 31 (2007), 1; 5-36 (international peer review, article, scholarly)

- Turkalj, Goran; Brnić, Josip; Vizentin, Goran; Lanc, Domagoj. Modelling of connections in FE stability analysis of framed structures. // Bulletins for Applied & Computer Mathematics, 109 (2007), 2284; 91-96 (information about peer review not available, article, scholarly)
- Turkalj, Goran; Vizentin, Goran; Brnić, Josip; Lanc, Domagoj. Finite element buckling analysis of frames with flexible connections. // Mashinostroene, LV (2006), 7-8; 72-75 (information about peer review not available, article, scholarly)
- Turkalj, Goran; Vizentin, Goran; Lanc, Domagoj. FE stability analysis of elastic frames accounting for connections flexibility. // Scientific Bulletin of the 'Politehnica' University of Timisoara, Transactions on Mathematics & Physics, 51(65) (2006), 2; 41-49 (information about peer review not available, article, scholarly)
- Čehić, Zlatan; Turkalj, Goran; Vizentin, Goran. Buckling analysis of curved beam considering curvature effects. // Bulletins for Applied and Computer Mathematics, 107 (2005), 2238; 29-34 (information about peer review not available, article, scholarly)
- Turkalj, Goran; Brnić, Josip; Vizentin, Goran. Finite element model for initial stability analysis of semi-rigid frames. // Bulletins for Applied and Computer Mathematics (BAM), 107 (2004), 2226; 31-38 (information about peer review not available, article, scholarly)
- Turkalj, Goran; Čanađija, Marko; Vizentin, Goran. Free vibration of biclamped beam-type structures. // Bulletins for Applied and Computer Mathematics, 103 (2003), 2078; 35-42 (information about peer review not available, article, scholarly)

- Scientific conference proceedings papers
 - Vizentin, Goran; Vukelić, Goran. Failure Analysis of FRP Composites Exposed to Real Marine Environment. // Book of abstracts of the 4th International Conference on Structural Integrity / Moreira, Pedro; Tavares, Paulo (ed.). Madeira: The International Conference on Structural Integrity, 2021. pp. 84-84 (lecture, abstract, scholarly)
 - Vukelić, Goran; Vizentin, Goran; Masar, Aleksandra. Hydraulic Torque Wrench Adapter Failure Analysis. // Proceedings of 18th International Conference on New Trends in Fatigue and Fracture / Reis, Luis; Freitas, Manuel; Anes, Vitor (ed.). Lisbon: IDMEC Instituto de Engenharia Mecânica Instituto Superior Técnico University of Lisbon, 2018. pp. 213-216 (lecture, international peer review, abstract, scholarly)
 - Vukelić, Goran; Vizentin, Goran. Experimental and Computational Failure Analysis of a Compressor Pressure Regulator. // ACE-X 2017. Abstract Book / Öchsner, Andreas (ed.). Wien: ACE-X Conference, 2017. pp. 20-21 (lecture, international peer review, abstract, scholarly)

Curriculum Vitae

Goran Vizentin was born in Rijeka, Croatia in 1975. He obtained bachelor's degrees in mechanical and electrical engineering. He received the masters of science (MSc) degree in 2006 at the Faculty of Engineering, University of Rijeka. Since the end of 2016 he is an employee of the University of Rijeka, Faculty of Maritime Studies, Department of Marine Engineering and Energetics as a research and teaching assistant. He has been a teaching assistant on the courses Engineering Mechanics, Thermodynamics and Materials at the undergraduate university studies of Marine Engineering and Technology and Organization of Transport, and Applied Numerical Methods in Engineering at the graduate study of Marine Engineering and Maritime Transport Technology. In 2017 he enrolled in the Postgraduate Doctoral (PhD) Program "Maritime Studies", Marine Power and Engineering Systems module, under the supervision of Assoc. Prof. Goran Vukelić, Ph.D. Since 2017 he is involved various research projects in the areas of structural failures, behavior of materials exposed to the marine environment and maritime educational standards. He is a member of the Croatian Chamber of Mechanical Engineers and Croatian Society for Mechanics

PART II
INCLUDED PUBLICATIONS

A. Effect of time-real marine environment exposure on the mechanical behavior of FRP composites

Goran Vizentin, Darko Glujić, Vedrana Špada

Abstract: Fiber reinforced polymer (FRP) composites coupons have been exposed to real sea environment in order to assess the influence on the mechanical behavior of composite materials used in the construction of marine structures. Real life sea environment conditions were opted for instead of the more common simulated and laboratory versions of seawater in the attempt to obtain more realistic structural modeling environmental input design parameters for marine structures. Exposure was performed over prolonged time span, instead of usual accelerated tests. Epoxy and polyester resins, reinforced with glass fibers in three fiber layout configurations were used to manufacture standardized tensile testing coupons. Mass changes due to seawater absorption, microorganism's growth, changes in tensile strength (standard tensile tests) and surface morphology of the coupons were evaluated after 6- and 12-months long periods of submersion in the sea in the Rijeka bay, Croatia. All specimens have shown mass increase due to water absorption and growth of attached algae and sea microorganisms. Various levels of reduction in tensile strength, depending on the fiber layout configurations, were observed. Significant changes in the matrix material structure were noticed, effectively producing "voids". Based on these results, sustainability of FRP composites in marine environment is addressed and discussed.

Keywords: composites; sustainability of composites; marine environment; FRP composites

1. Introduction

Fiber reinforced polymer (FRP) composites have been used in the construction of marine vessels and structures since the middle of the 20th century, whether it be as an exclusive option for construction [1] or as a combination with traditional materials, like steel [2] or concrete [3]. The design of these structures in aspects of strength, durability and environmental influence on the mechanical properties has been based mainly on experience for the best part of the said period. In the last couple of decades, significant effort has been made to combine the experimental and scientific knowledge obtained so far in these field of research in order to enable prediction models that can be safely used to achieve sustainable and safe design of marine structures [4–7].

Mechanical properties of composite materials can be customized accordingly to specific applications demands by defining layup sequences, number of plies and fiber orientation in the load direction [8–10], which makes them appealing for design of marine structures with complex shapes. As the application field for marine composites widens, the request for resilience to mechanical loading and environmental influences

rises. Adequate knowledge of limit state assessment, durability and life span, failure modes, fracture toughness, fire resistance and environment influence parameters are crucial for an efficient and sustainable design process for structures in this demanding industry sector [11].

The micromechanical aspect of composite materials design is often considered too complex and time consuming for marine structural designers to be dealt with. The scientific research in this field of study should be aimed to simplify the complex, micromechanical level analysis and transform it into simple to use and time saving engineering tools. The current practice for obtaining data for composites failure is based on experiments. As experiments can be relatively expensive and micro scale data is usually unavailable to shipbuilders, they often turn to data and models prescribed by rules and procedures, thus leading to empirical based design process of marine structures. All of this yield in rules that are very conservative in formulating the design requests, which in turn hinders optimal design of marine structures concerning failure mechanisms.

One of the most important parameters influencing the mechanical properties of composite materials in marine applications is the absorption of seawater [12]. Previous research on this matter is based on immersing test samples, called coupons, in laboratory conditions using accelerated procedures [13] to simulate 20+ years of expected lifespan of typical marine structures [14,15]. The ageing of composites is usually carried out in climatic chambers in laboratory conditions [6,16,17] in order to reduce the time of the test [18–21].

In addition, water absorption tests are often done with tap, demineralized water or artificial seawater [22,23]. This approach yields a lack of long-term data pertaining to degradation of mechanical properties exposed to the marine environment. Furthermore, the effects of the moving seawater (waves, sea level variations due to tides), radically variant environmental effects that a typical marine vessels and structures are exposed during their life cycle (vessels sailing all over the world, changes in salinity, climate) are not considered in accelerated ageing laboratory methods.

The absorption process of moisture and water of a composite exhibits complex behavior and dependence on various factors [24] such as resin type and curing

characteristics, void content, resin/fiber volume fractions [25], the manufacturing technique etc. [26–28].

All this served as motivation to concentrate the research presented here on the influence of absorbed water on marine composites in real life conditions, not laboratory, by submerging the coupons in the sea for prolonged periods of 6 and 12 months.

The dominant choice of composite materials in the civil sector of the marine vessels industries is glass fiber reinforced plastics (GRP), both for commercial and leisure vessels hulls [29], resulting in a more cost-effective product. Classification societies can be somewhat restrictive when it comes to allowing composites as structural material. The choice of fibers is restricted to E-glass or carbon fibers, whilst resins are limited to epoxy, polyester or vinyl-ester [30], [31], [32].

The scope of the experimental research presented in this paper is the absorption of composite coupons in real sea environment and the assessment on the impact of the seawater on the mechanical properties of the material.

2. Materials and Methods

2.1. Materials

The ISO 527-4 [33] standard prescribes the testing procedures for determination of tensile properties of fiber-reinforced plastic composites, both for unidirectional (UD) and multidirectional reinforcements.

In this paper, epoxy and polyester resins with glass fibers were used to manufacture standardized tensile testing coupons. Two matrix/fiber combinations were used, namely epoxy/glass and polyester/glass. The epoxy resin (Sicomine SR 8200 and SD 720 series hardener) and the polyester resin (Reichhold POLYLITE 507-574) mechanical properties are shown in Table 1, as provided by the manufacturers of each component.

Table 1. Resin systems properties

Property	Epoxy	Polyester
Tensile strength [MPa]	47	42
Elasticity modulus [MPa]	3240	2700
Glass transition temperature [°C]	50	55

The fibers used in manufacturing the coupons are in the form of a UD stitched E-glass fiber fabric (Sicomín UDV600), with 594 g/m² ply specific area weight.

Four different layup configurations have been chosen for both matrix/fiber combinations in order to evaluate mechanical properties deterioration in the marine environment. The layup schematics are as follows, according to standard notation for composite layup [34]:

- Unidirectional with longitudinal fiber orientation – UD0
- Multidirectional – (0/90)_s
- Multidirectional – (0/45/90)_s.

Three rectangular plates measuring 300×450 mm with three different layup schemes (UD0, 0/90, (0/45/90)_s), were produced for each of the material combinations using 8 plies of the UD fabric per plate, Figure 1. The epoxy/glass plates were produced by vacuum assisted infusion process, resulting in 3±0.2 mm thick plates. The infusion process proved problematic for the polyester resin as it was resulting in dry fibers on the tool surfaces, so the polyester/glass plates were finally produced by hand layup process resulting in 5±0.5 mm thick plates.

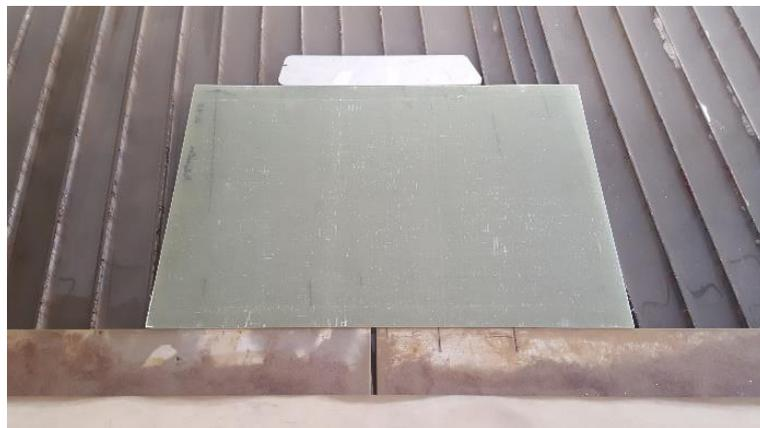

Figure 1. Composite plate prepared for waterjet cutting.

2.2. Coupons and Exposure to Marine Environment

Coupons measuring 250 mm in length and 25 mm in width [33] were then cut out of the plates on a waterjet cutting machine (OMAX Maxiém series), Figure 2. The cutting

pressure was between 1400 and 3400 bar, with the average cutting speed of 1187 mm/min.

Waterjet cutting was chosen based on previous experience in cutting similar materials. The brittleness of glass and composite materials causes localized damage on the locations of first contact of the cutting high-pressure waterjet with the material. This enabled the precise positioning of the damage point on the coupon gauge length during the configuration of the waterjet machine. The intent here is to introduce a damage point, which is to simulate real damage on marine structures. This damage point represents a facilitated entry point of seawater in a real structure. Composite marine vessels and structures are usually protected by a final layer of gel coat that protects them from water penetration. When this protective layer is damaged during application, a more significant sea water intake rate in the structure material is enabled.

All the coupons were then weighed dry and measured with a ± 0.1 mm accuracy.

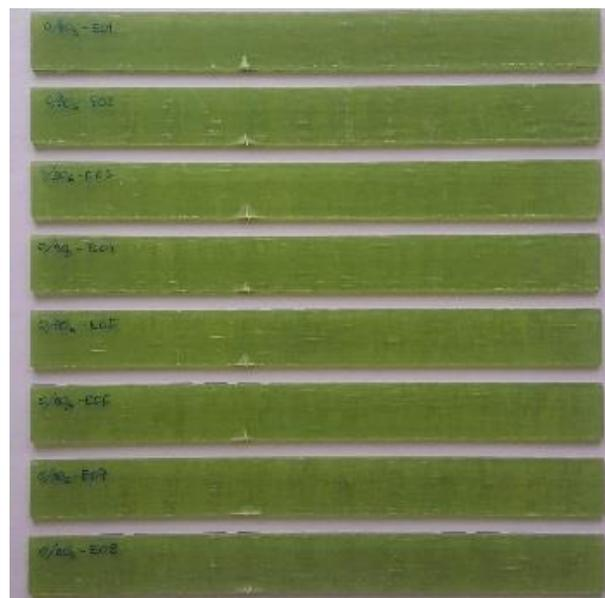

Figure 2. Cut out coupons

The machined coupons were divided into 2 main groups by material combinations (epoxy/glass, polyester/glass), and in 3 subgroups according to the duration of exposure to the marine environment (dry, 6 months, 12 months). Each group consisted of 5 specimens (coupons). The first subgroup of coupons was not submerged but tested dry, to be used as a control group.

The other two subgroups were exposed to real-life sea environment, i.e. submerged into the sea on a depth of 10 m, at northern Adriatic in front of the city of Rijeka in Croatia for a duration of 6 and 12 months, respectively. The sea temperature at the location of experiment is varying between 10 and 14 °C annually, salinity changes between 37.8 and 38.3 PPT, while the pH value is between 8.22 and 8.29 [35]. The coupons were mounted on special stainless-steel frames (AISI 316L), shown in Figure 3.

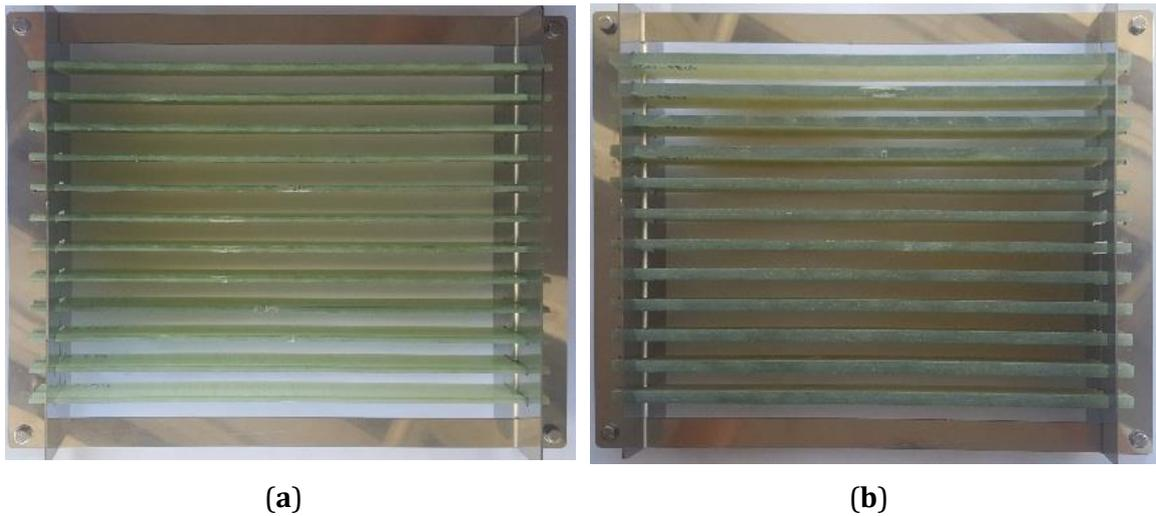

Figure 3. Coupons mounted on special stainless-steel frame before submersion: **(a)** Epoxy/glass; **(b)** Polyester/glass.

2.3. Testing Procedures

Each coupon was weighed with the same digital scale with a 200 g measuring range and 0,01g resolution before (dry) and after the submerging time-period in order to determine the mass gain of the absorbed seawater. Wet coupons were taken out of the sea, cleaned from sea organisms accumulated during submersion with a soft brush, still submerged in seawater. Special care was taken not to damage the coupon. After cleaning, the coupons were left to drain, dried superficially with a cloth and weighed all under one minute to assure minimal possible drying of the coupons.

Reinforcement tabs, made of printed circuit board cutouts, were added at the coupon ends before the tensile test in order to minimize the influence of the grips pressure on the test results [36]. The size of the tabs was chosen based on ISO 527-4 recommendations, Figure 4.

Uniaxial tensile tests used for the determination of the material properties were performed on a Zwick 400 kN (ZwickRoell GmbH, Germany) universal testing machine. A macro extensometer was used to measure the specimens' elongation. The displacement rate of the testing machine crosshead during testing was 2 mm/min.

Tensile testing was conducted in accordance to ISO 527 series standards recommendations.

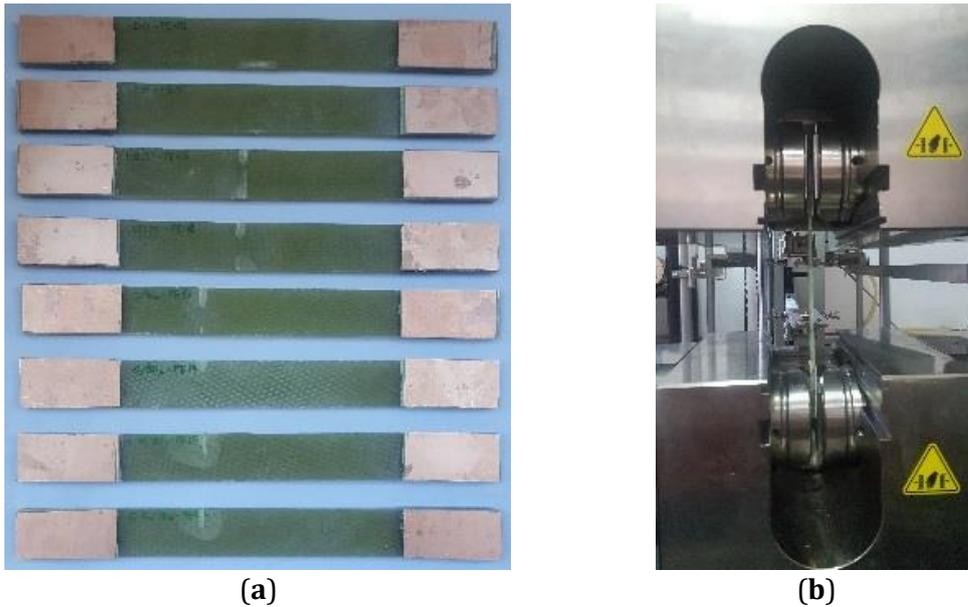

Figure 4. Coupons: (a) with reinforcement tabs; (b) gripped in the tensile testing machine.

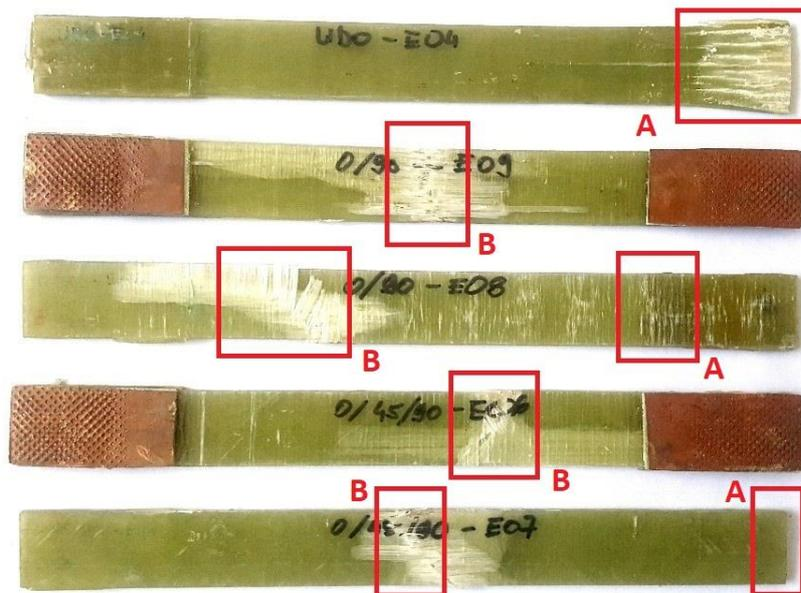

Figure 5. Coupons after tensile testing, locations for microscopical examination.

Microscopical investigation was performed on fractured coupons of three fiber layout configurations (UD0°, (0/90)s, (0/45/90)s) and for both dry coupons and coupons submerged in the sea for different periods i.e. 6 and 12 months. Surface and cross-sectional images were taken of all coupons, with special attention given to the grips areas (A) and locations with observed damage after the tensile test (B), Figure 5.

Optical microscopy systems (Olympus SZX10 stereo optical microscope and Olympus BX51 SM optical microscope analysis system, both produced by Olympus corporation, Japan) and scanning electron microscope (SEM, FEI QUANTA 250 FEG, FEI Company, USA) with the OXFORD INSTRUMENTS PENTAFET, UK, Energy Dispersive Spectroscopy (EDS) analysis module were used to investigate the state of the coupon's surfaces exposed to real sea environment and to identify changes in surface morphology caused by the exposure to seawater. Photographs were taken before and after the tensile tests.

3. Results

The results of the experimental investigation of Epoxy/glass and Polyester/glass coupons exposed to marine environment are presented in the form of diagrams, images and tables. Experimental testing results shown here are comprised of coupon weight change (seawater absorption, algae growth) analysis, tensile strength determination and surface morphology changes observations.

3.1. Algae and marine organisms growth

The average aggregate mass gain due to the coupled algae/marine organisms' growth and water absorption for the two matrix resins is given in table 2.

Table 2. Mass gain due to algae growth and water absorption

Resin	Period of exposure	Mass increase [%]		
		Minimum	Maximum	Average
Epoxy	6 months	0.929	3.892	1.971
	12 months	5.070	11,175	7.856
Polyester	6 months	0.863	1.758	1.286
	12 months	2.551	13.940	8.687

3.2. Water absorption and mass change analysis

The cleaned coupons mass measurement results after the period of 6 and 12 months of submersion are shown below, Figure 6.

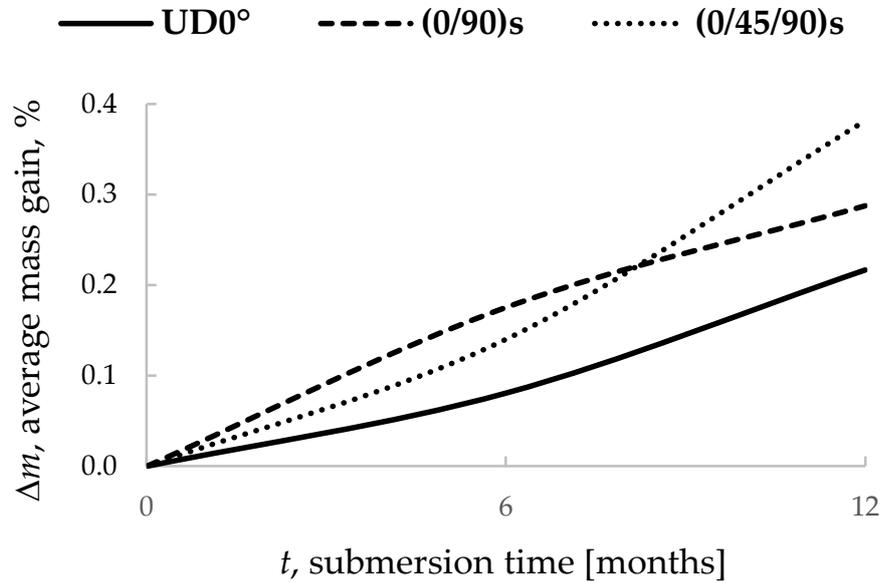

(a)

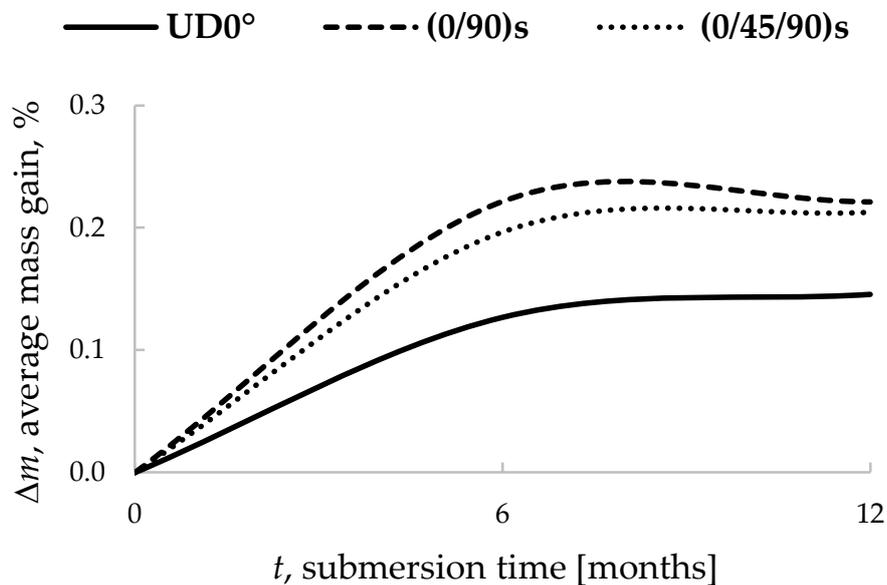

(b)

Figure 6. Average mass gain due to seawater absorption: (a) epoxy resin; (b) polyester resin.

The minimum and maximum values of the mass gain for all layout configurations and material combinations are given in tables 3 and 4.

Table 3. Mass gain due to seawater absorption, epoxy resin

Fiber layout configuration	Period of exposure	Mass increase [%]		
		Minimum	Maximum	Average
UD0°	6 months	0.070	0.092	0.081
	12 months	0.133	0.300	0.217
(0/90) _s	6 months	0.158	0.211	0.175
	12 months	0.087	0.423	0.288
(0/45/90) _s	6 months	0.078	0.198	0.140
	12 months	0.252	0.502	0.381

Table 4. Mass gain due to seawater absorption, polyester resin

Fiber layout configuration	Period of exposure	Mass increase [%]		
		Minimum	Maximum	Average
UD0°	6 months	0.099	0.155	0.127
	12 months	0.018	0.199	0.103
(0/90) _s	6 months	0.194	0.258	0.222
	12 months	0.040	0.128	0.083
(0/45/90) _s	6 months	0.070	0.300	0.197
	12 months	0.173	0.266	0.213

3.3. Tensile test results

Engineering stress-strain diagrams were obtained from performed uniaxial tensile strength on dry coupons and wet coupons that have been submerged in the sea for 6 and 12 months, Figures 7 to 12.

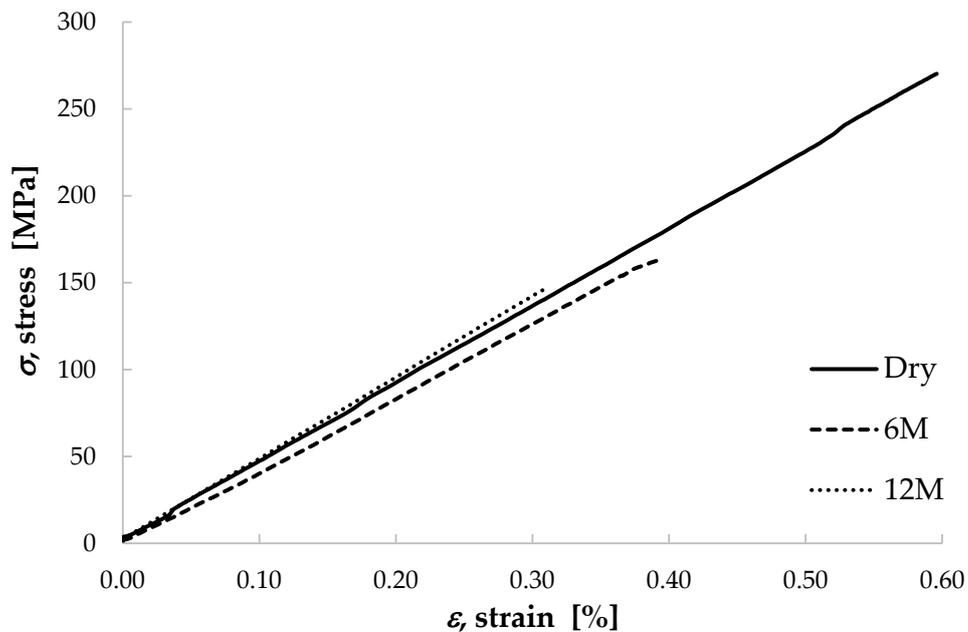

Figure 7. Engineering stress-strain diagrams for epoxy/glass UD0° coupons submerged in the sea for 6 (6M) and 12 months (12M).

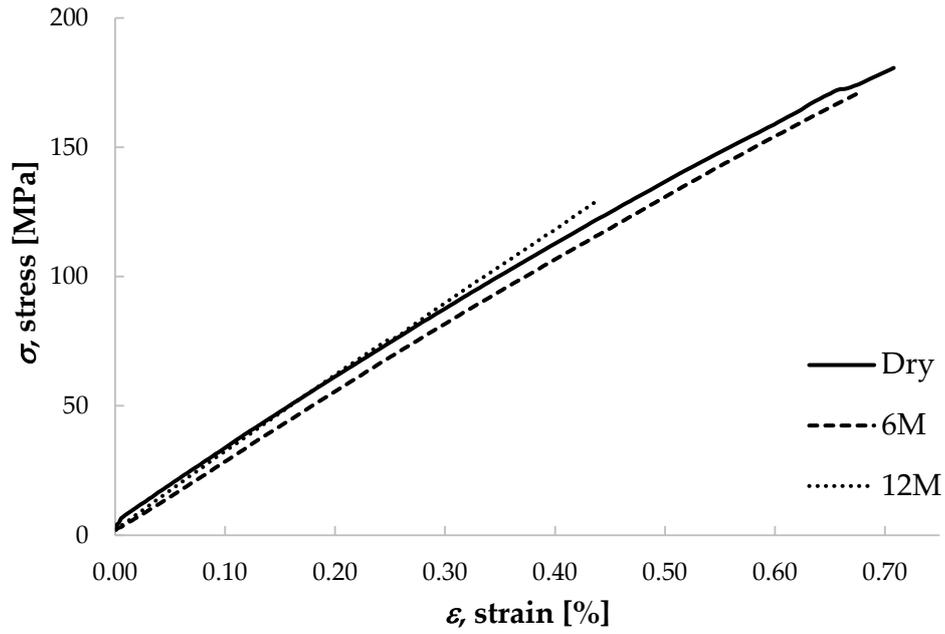

Figure 8. Engineering stress-strain diagrams for epoxy/glass (0/90)s coupons submerged in the sea for 6 (6M) and 12 months (12M).

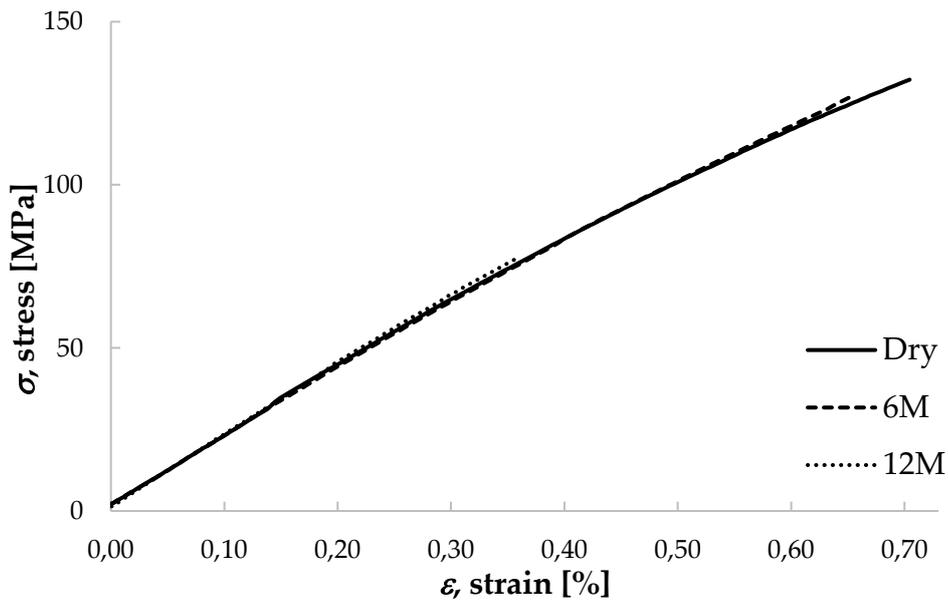

Figure 9. Engineering stress-strain diagrams for epoxy/glass (0/45/90)s coupons submerged in the sea for 6 (6M) and 12 months (12M).

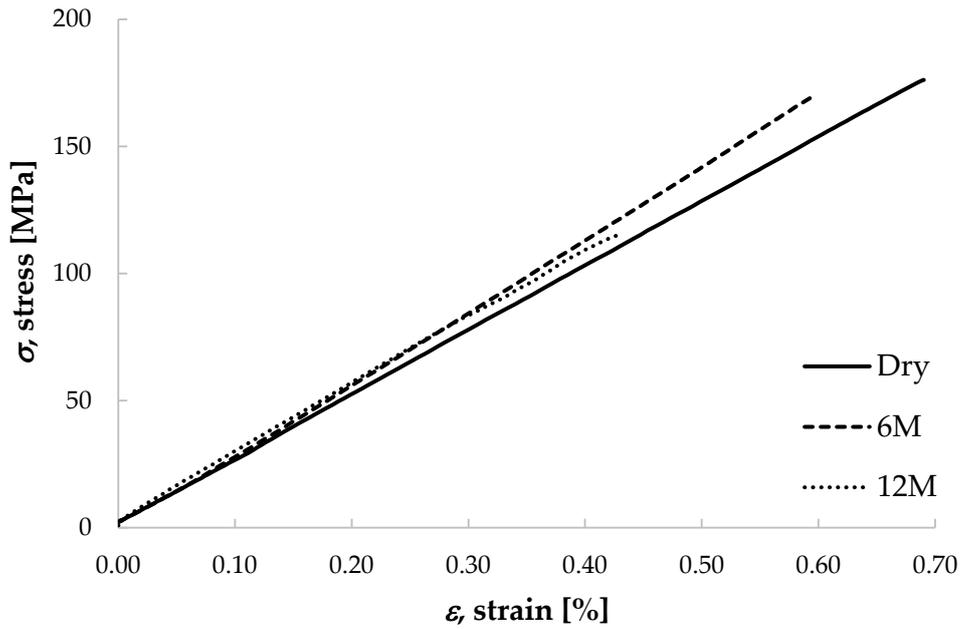

Figure 10. Engineering stress-strain diagrams for polyester/glass UD0° coupons submerged in the sea for 6 (6M) and 12 months (12M).

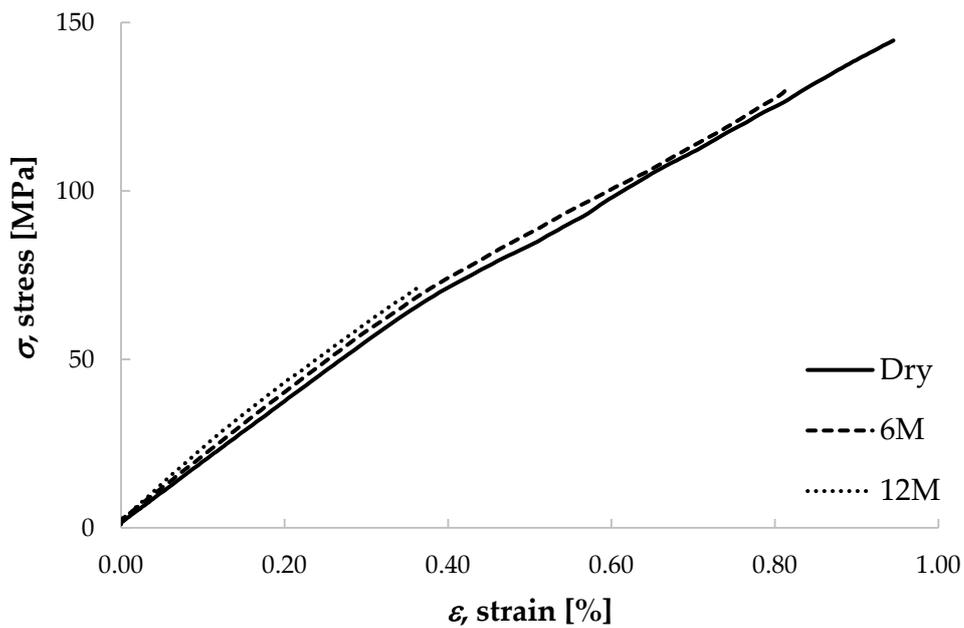

Figure 11. Engineering stress-strain diagrams for polyester /glass (0/90)s coupons submerged in the sea for 6 (6M) and 12 months (12M).

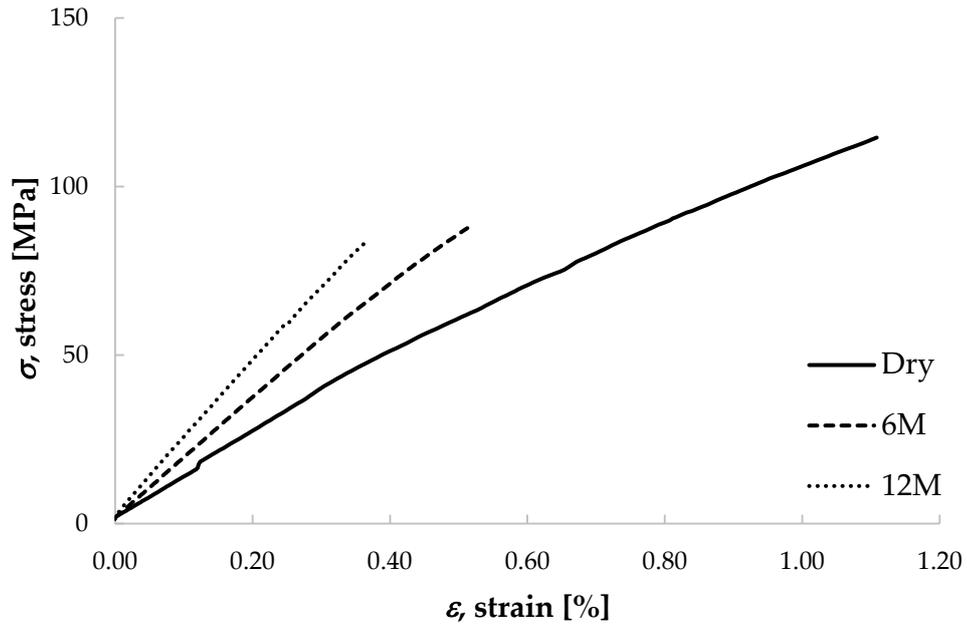
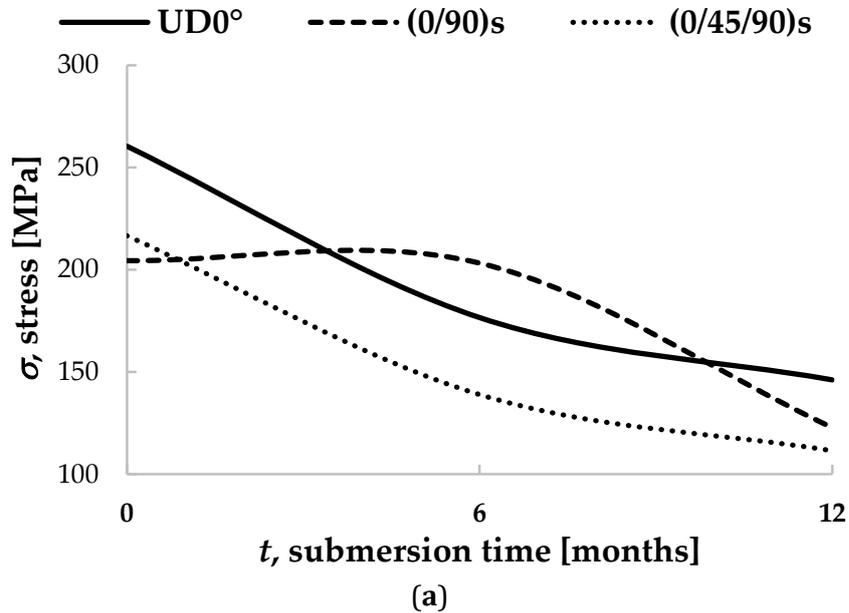
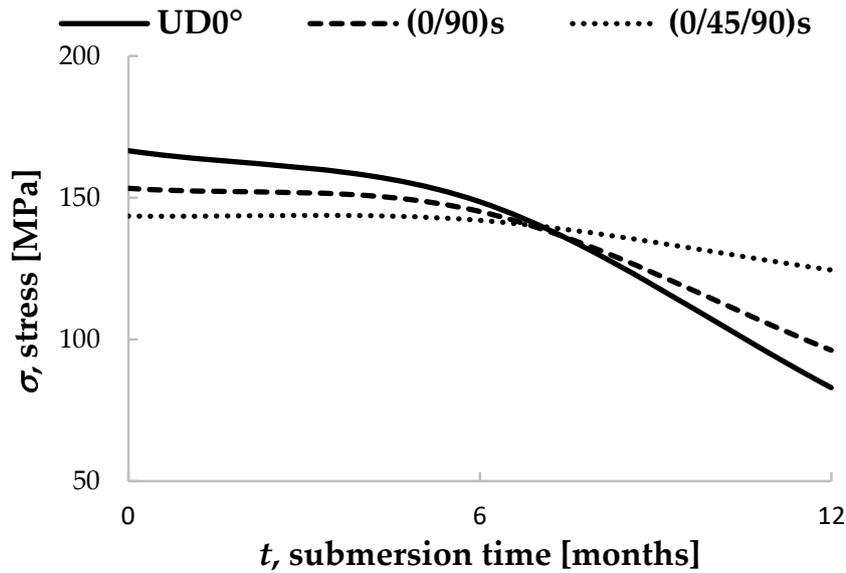

Figure 12. Engineering stress-strain diagrams for polyester /glass (0/45/90)s coupons submerged in the sea for 6 (6M) and 12 months (12M).

The change in tensile strength due to the prolonged submersion in seawater is shown, Figures 13 and 14.



(a)



(b)

Figure 13. Average tensile strength degradation: (a) epoxy resin coupons; (b) polyester resin coupons

3.4. Microscopical investigation

Surface and cross-sectional images obtained by optical microscopy are not presented here but are available in a publicly accessible repository in order to save paper space and keep the readers focus on the more detailed and more illustrative SEM results.

The images obtained by SEM investigation are presented in Figures 14 to 19. Only several representative images were chosen as a portrayal of the performed research in order to limit the length of the paper.

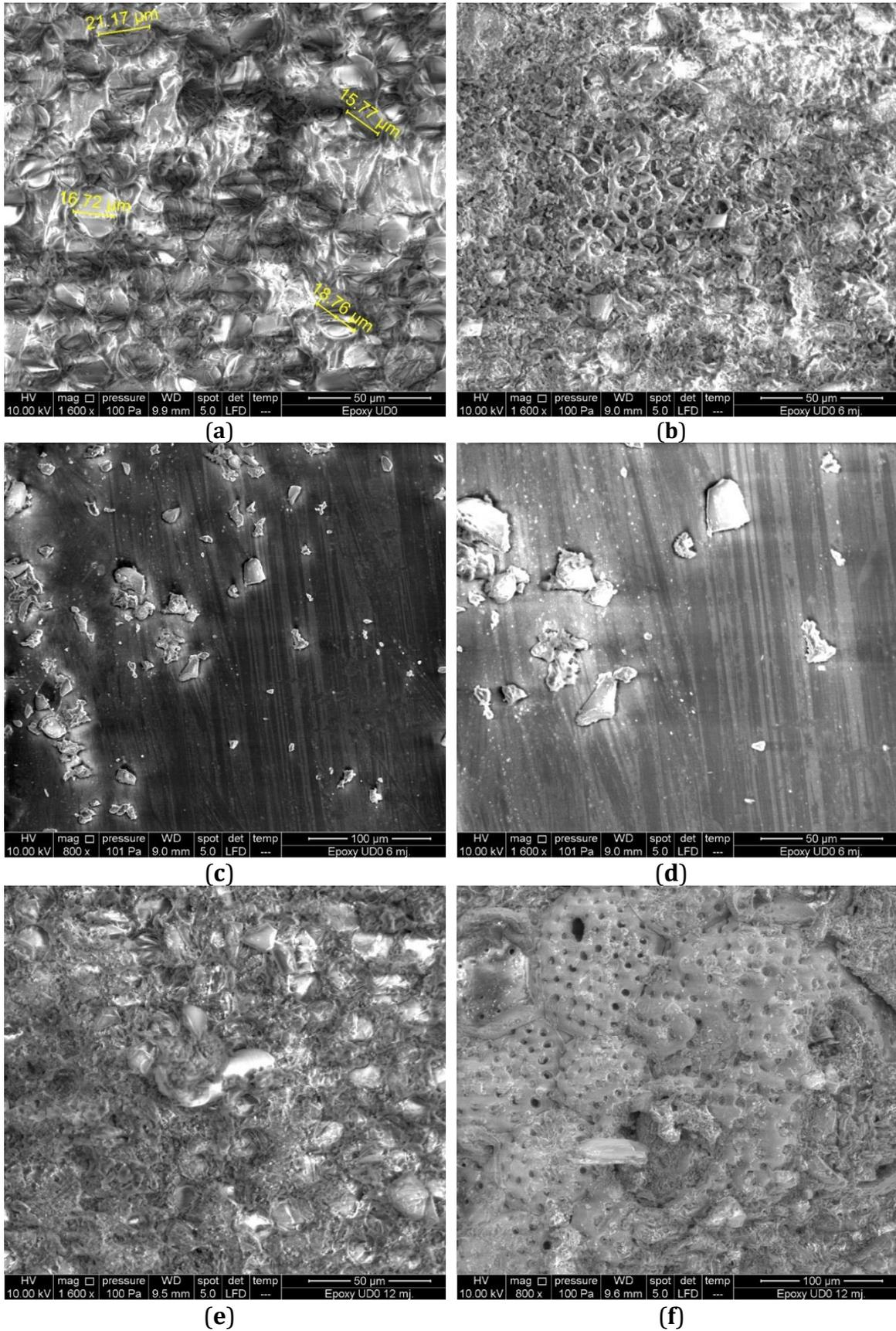

Figure 14. SEM epoxy UD0°: (a) dry; (b) 6 months submersion; (c) and (d) salt crystals after 6 months; (e) and (f) microorganisms' growth after 12 months

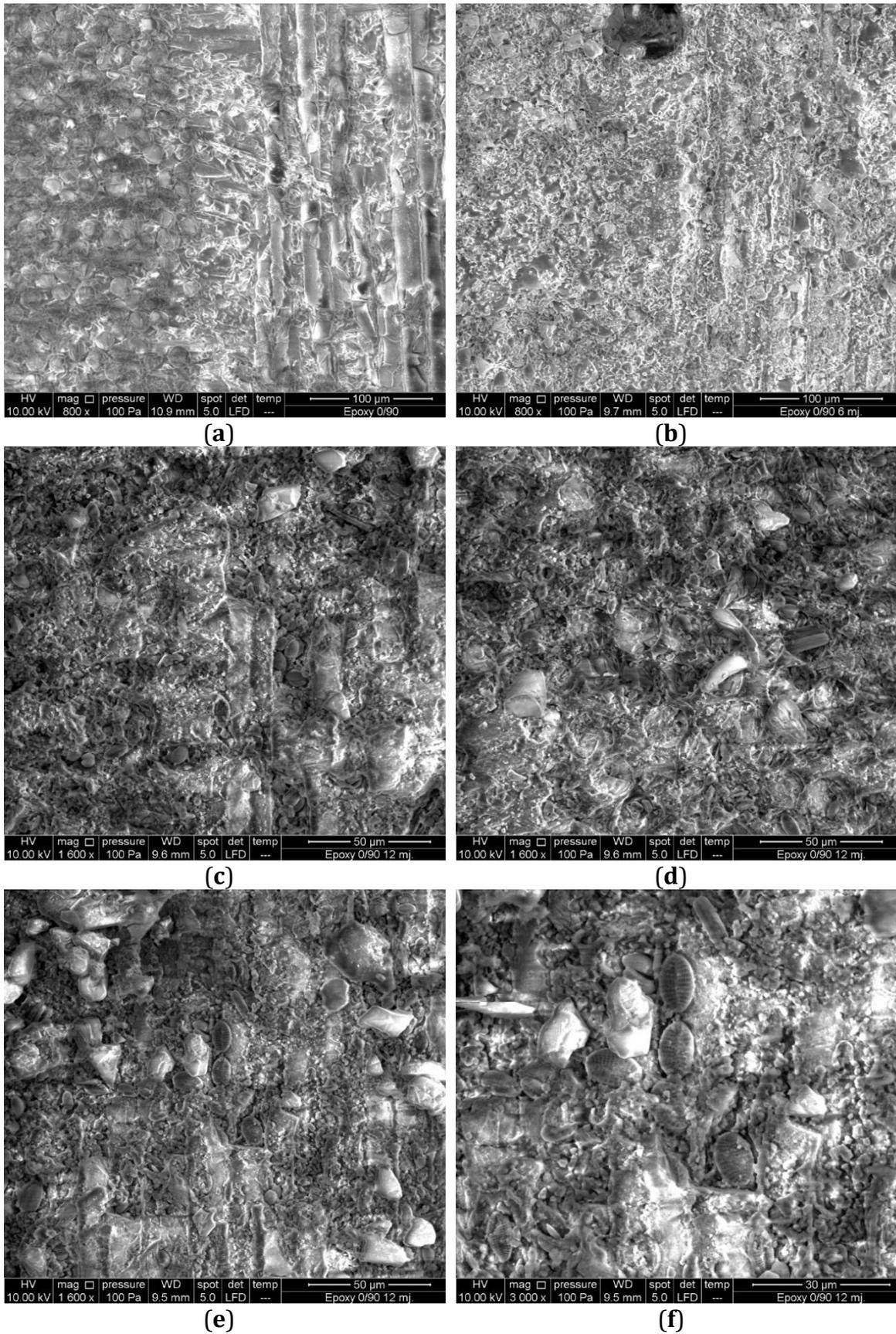

Figure 15. SEM epoxy (0/90)s: (a) dry; (b) 6 months submersion; (c) and (d) salt crystal formations; (e) and (f) microorganisms' growth after 12 months

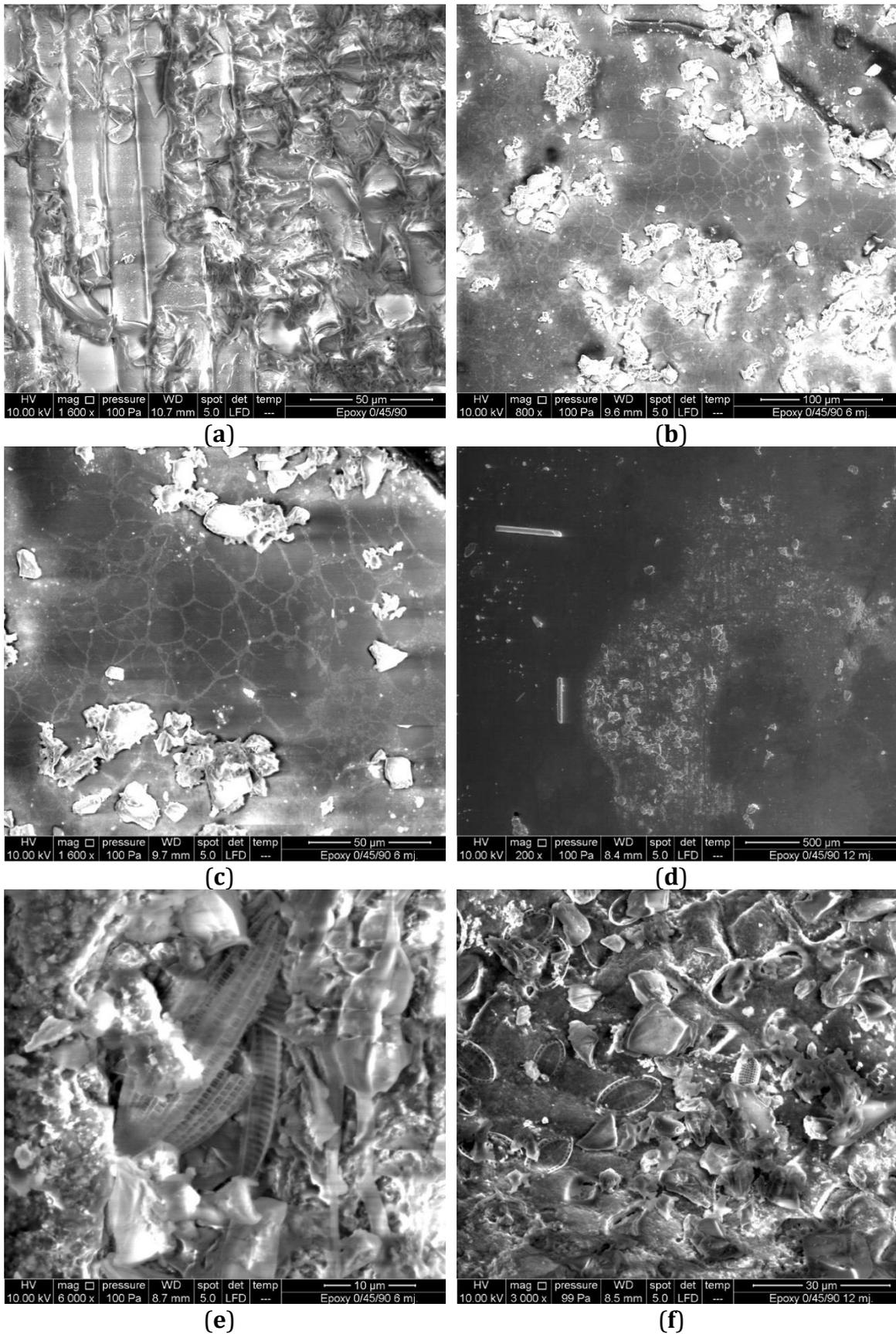

Figure 16. SEM epoxy (0/45/90)s: (a) dry; (b), (c) and (d) salt crystals 6 and 12 months submersion; (e) and (f) microorganisms' growth after 6 and 12 months

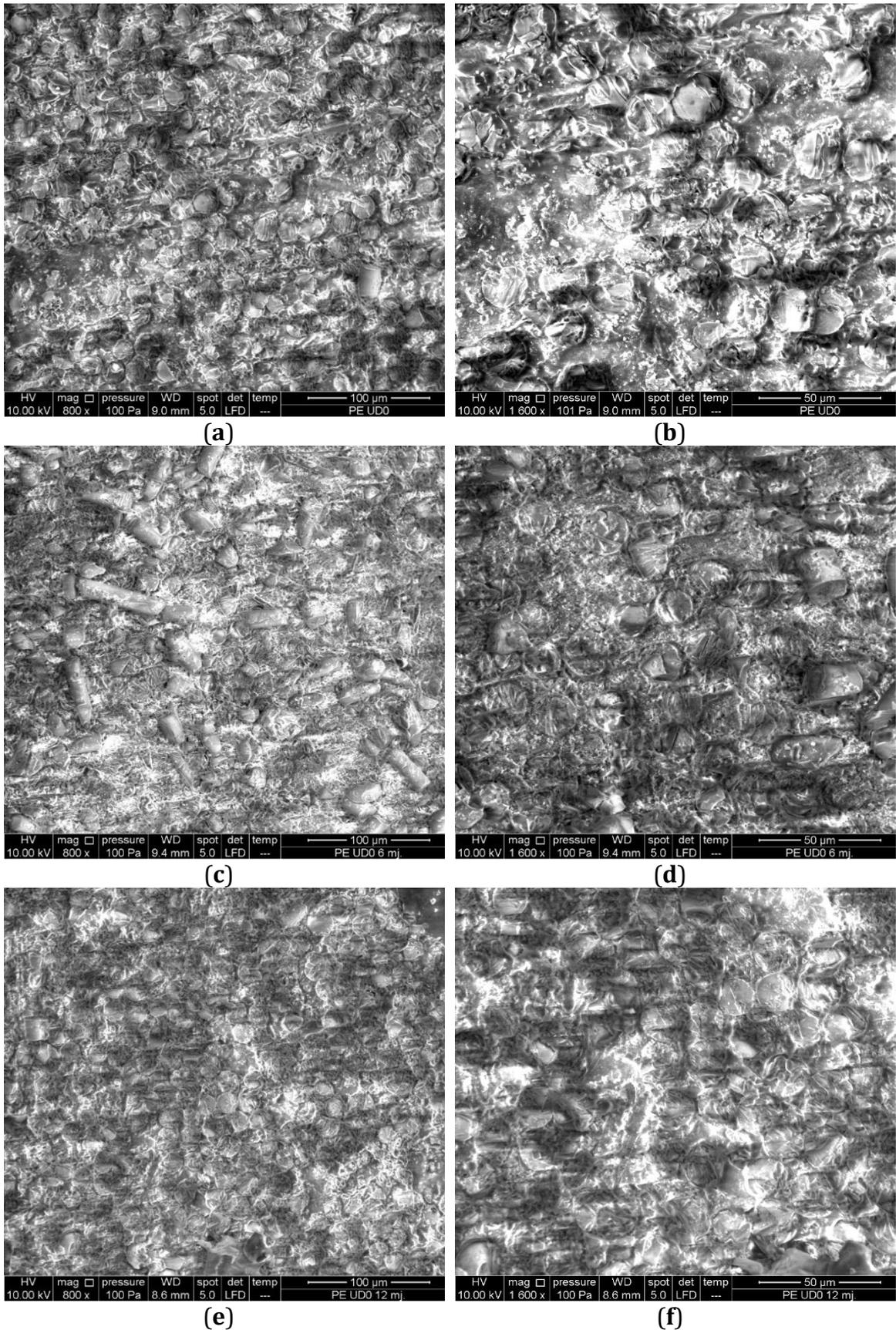

Figure 17. SEM polyester UD0°: (a) and (b) dry; (c) and (d) salt crystals 6- months submersion; (e) and (f) 12- months submersion

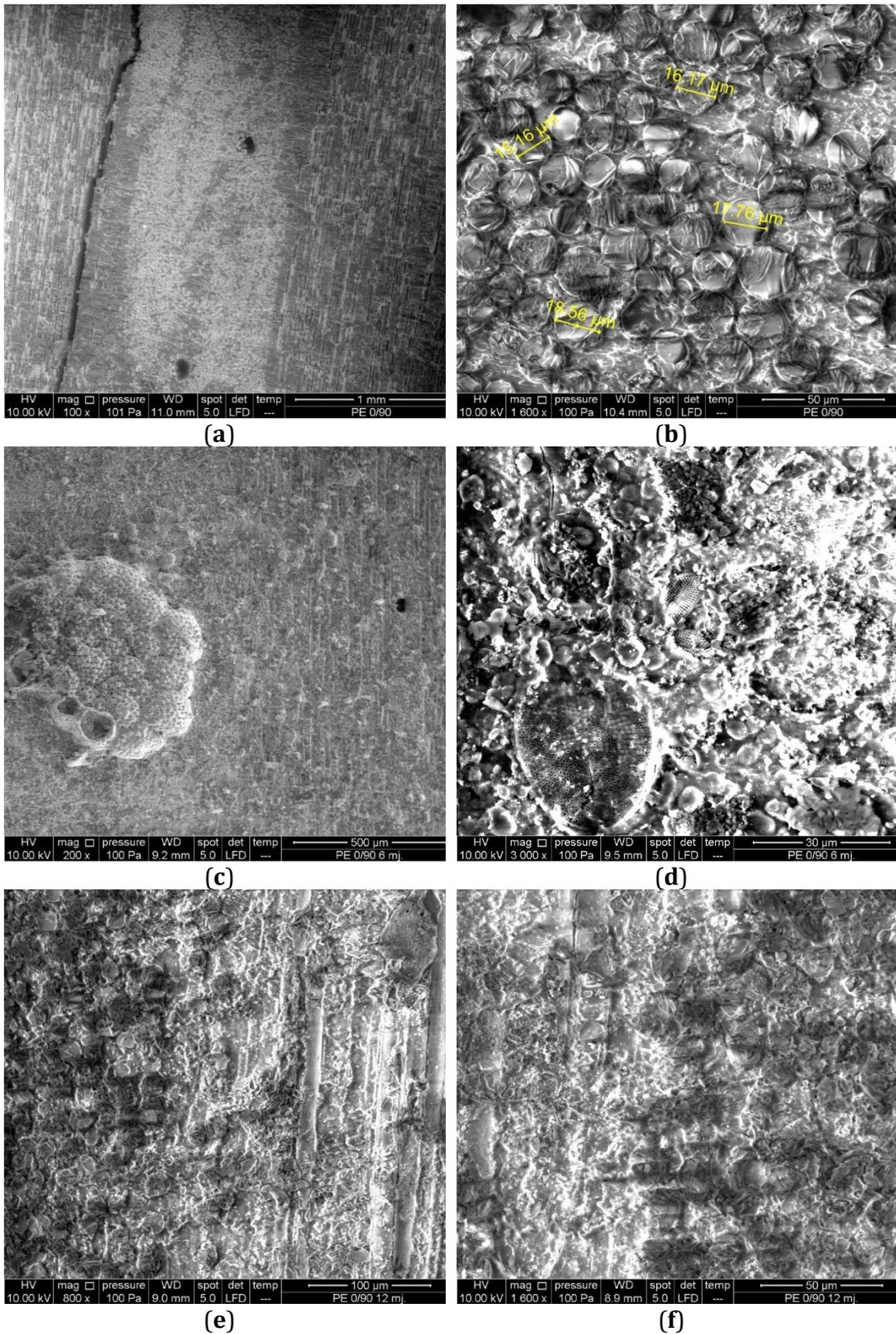

Figure 18. SEM polyester (0/90)s: (a) and (b) dry, manufacturing imperfections; (c) and (d) microorganisms' growth after 6 months of submersion; (e) and (f) 12 months of submersion

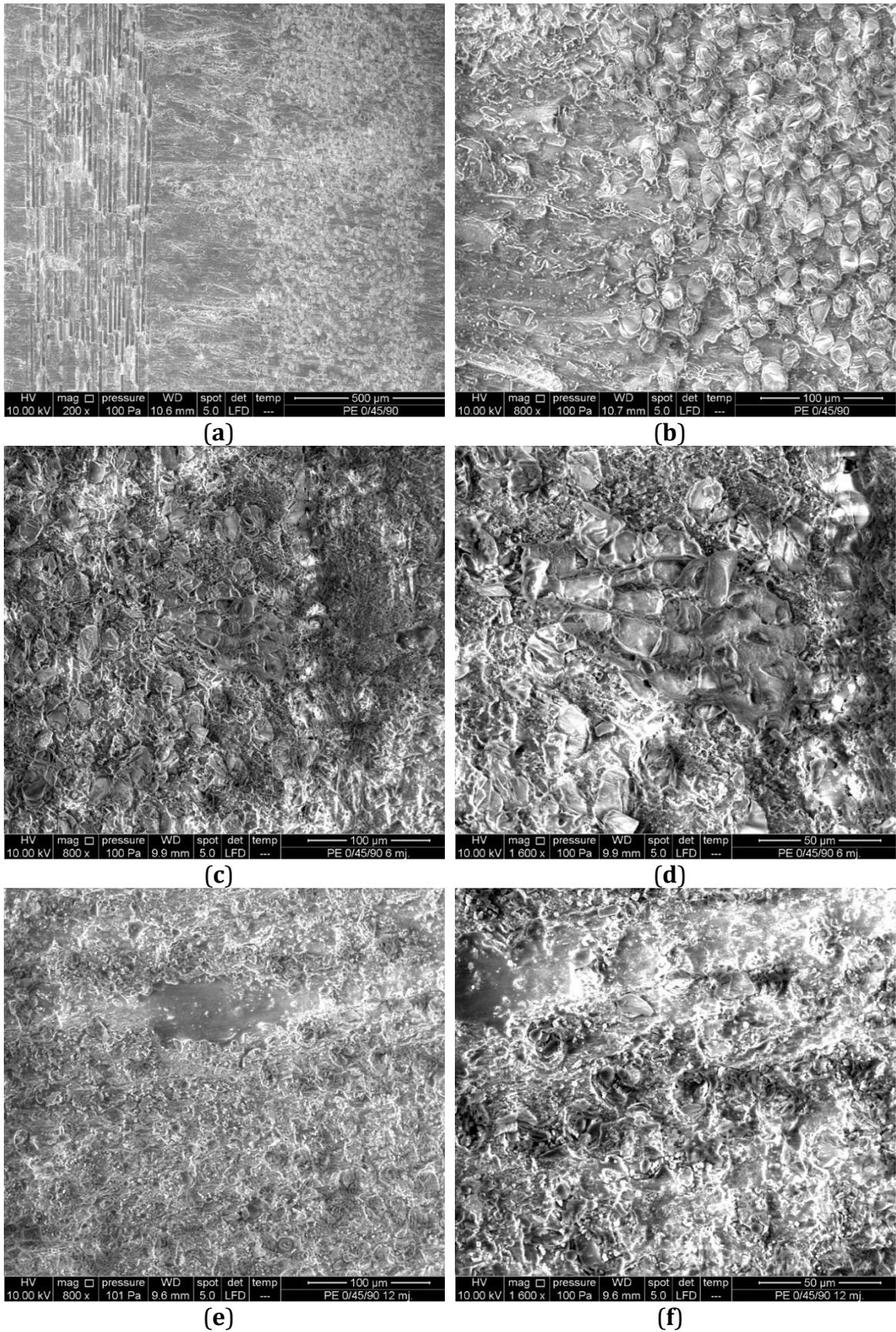

Figure 19. SEM polyester (0/45/90)s: (a) and (b) dry; (c) and (d) resin degradation, 6 months submersion ; (e) and (f) microorganisms in the resin, 12 months of submersion

4. Discussion

The mass measurement of all coupons before and after the submersion has shown an increase of mass for all coupons, Tables 3 and 4, Figure 6. The epoxy resin coupons have shown a greater average mass gain due to water absorption compared to polyester ones. Of the total of six resin material/fiber layout configurations, epoxy coupons with (0/90)s layout and all of the polyester coupons have shown signs of water absorption saturation in the one year period. The epoxy UD0° and (0/45/90)s fiber layout have still and rising mass gain curve indicating that water absorption saturation has not been achieved after one year of submersion, Figure 6a. The (0/45/90)s fiber layout configuration coupons for both resin types have shown the greatest mass gain compared to the other fiber layout configurations.

Polyester matrix coupons have amassed more microbial growth than the epoxy ones. This emphasizes the importance of the application of real sea environment instead of, in similar researches, more commonly used artificial sea and environmental conditions generated in a laboratory.

In all the diagrams in figures 7 to 12 the reference stress-strain curve is designated as “Dry”. This curve represents the tensile mechanical properties of coupons not exposed to seawater. All submerged specimens have had reduced tensile strength in average. Polyester resin coupons had a more pronounced drop in strength in the period from the 6th to the 12th month, figure 13b, while the epoxy resin coupons exhibited greater tensile strength loss after the first 6 months of submersion. The only exception from this behavior was noticed by the epoxy coupons with the (0/90)s fiber layout configuration, figure 14a. This is to be attributed to a single specimen from the group of this material and fiber layout combination submerged in the sea for 6 months exhibiting “extreme” tensile strength. By further examination, a higher fiber content in the said specimen was identified compared to the other specimens from the same group. This goes to show that the manufacturing process has a strong impact on the mechanical properties of the finalized composite part.

It is important to consider that the environmental conditions (sea temperature, currents, sea level etc.) were not constant as they would be in a laboratory-based environment. The first 6 months of submersion spanned from late autumn to early

summer i.e. predominantly colder environmental conditions. Subsequently, the next 6 months were predominantly warmer.

The results obtained in this research show a correlation with previous research results this topic done by other researchers [37–40]. The novelty of this research is the exposure to real sea environment with all the environmental and sea living organisms' effects acting simultaneously and randomly on the materials during the submersion as opposed to, more common, artificial and laboratory conditions often combined with accelerated absorption tests.

Analysis of the images collected during the microscopical investigation showed formation of salt crystals on the surface layers of the coupon as well as embedded salt crystals in both resins. The epoxy resin coupons showed a greater accumulation of salt crystals, figures 14c, 15e and 16c, than polyester ones, figures 17c, 18d and 19d, regardless of the fiber orientation setups.

One additional phenomenon noticed was the attachment and growth of marine microorganism on the organic resins used as matrix materials. The attachment and growth of sea microorganisms on the surface of the coupons was more intense in the first 6 months for the epoxy matrix coupons, but the total growth and maximum values after 12 months were more significant for the polyester ones, causing significant morphological changes in the resin, figures 17e, 18d and 19f. The (0/45/90)_s fiber configuration attracted the most microorganisms for the epoxy resin coupons, figures 16e and 16f, while for the polyester ones most organism were found in the (0/90)_s configuration, figures 18c and 18d. The algae attached to the surface of the coupons were easily removable during the cleaning of the coupons, and did not leave any noticeable macroscopic damage areas on the coupons.

However, the microorganisms that settled on the coupon's matrix were causing mechanical changes on the organic resin [41] effectively creating voids from the surface and into the matrix, hence additionally changing the mechanical properties of the composite. Since the polyester coupons were manufactured by hand layup, the number of imperfections and voids in the matrix was greater than in the vacuum infused epoxy coupons. This resulted in a greater number of favorable locations for the development of microorganisms and therefore a greater influence on the mechanical properties of the composite material.

5. Conclusions

Considerable effects of the real sea environment on composite materials were noticed in the form of reduced mechanical strength for the tested coupons submerged in the sea. The submerged UD0, (0/90)s and (0/45/90)s epoxy/glass coupons have exhibited tensile strength reduction of 32%, 14% and 36% after 6 months of submersion (with the exception of one inadequately manufactured (0/90)s coupon), whilst 44%, 40% and 49% after 12 months of submersion, respectively. The polyester/glass UD0, (0/90)s and (0/45/90)s coupons have lost 11%, 5% and 1% after 6 months of submersion and 50%, 37% and 13% after 12 months in the sea. The (0/45/90)s layout configuration for the polyester/glas combination has shown the greatest resilience to the marine environment. However, further study is needed here due to the fact that the polyester coupons have been made by hand-layup process which can significantly affect mechanical characteristics of the composite. This issue will be examined more in detail when the, already submerged, 24-month coupons batch will be extracted from the sea.

The growth of microorganisms embedded in the resin and invertebrate (Nematoda) organism attached to the surface of the coupons effectively created voids in the matrix resin and produced a direct effect on mechanical properties. As microorganisms are only able to accelerate chemo-physical erosion of the plastic surfaces in marine environment, probably through the secretion of corrosive substance (acids, hydrolytic catalysers etc.), further in-depth research on this effect is necessary.

The findings of the research indicate to the importance of biofouling in environmental degradation of mechanical properties of composite materials in the marine environment. Ageing of FRP composites in real-time and real marine environment differs to the more commonly used accelerated ageing methods, due to the effects of the marine organisms attached to the material. This can affect the accuracy of results obtained by the artificial environment and accelerated testing methodology if sufficient care is not taken to assure the replication of real marine environment and its effects.

More data from longer exposure is needed in order to enable the development of a reliable predictive numerical model of the mechanical behavior of composite materials exposed to real sea environment, which would represent a basic tool to assess the

durability and the sustainability of composite marine structures during their exploitation. Additional coupons have already been submerged in the sea to ensure the continuation of this research. This additional set of data will help in building predictive numerical model that could successfully replace the time and resource consuming experiments. However, stochastic nature of the environmental loading must be incorporated in that model. For that reason, placing coupons in different types of marine environment (regarding the temperature, salinity, pH value, etc.) would bring even better accuracy of the numerical model. Also, when it comes to use of composites in marine industry, it would be beneficial to place the test coupons in different locations in order to account for change in the structure of micro-organisms due to ballast water discharge. This is the path that should be followed in future research.

Sustainability of composites in general in the marine industry has often been emphasized in terms that composite materials offer the possibility of building lighter vessels that can carry more cargo and/or produce lower emissions, with the expansion of the maintenance intervals [42]. Potential sustainability needs, however, to be validated since different types of composites react differently when exposed to harsh marine environment. This study presents a step in that direction giving insight into the behavior and change of me-chemical properties for specific type of composites exposed for prolonged periods to the real marine environment.

Supplementary Materials: The complete set of SEM images obtained during this research is available on Vizentin, Goran (2021), “Marine Composites SEM”, Mendeley Data, V1, doi: 10.17632/j8tvmkpmwf.1

Author Contributions: Conceptualization, G.V.; methodology, G.V.; validation, G.V., D.G. and V.Š.; formal analysis, G.V.; investigation, G.V., D.G. and V.Š.; writing—original draft preparation, G.V.; writing—review and editing, D.G. and V.Š.; All authors have read and agreed to the published version of the manuscript.”

Funding: This research was funded by University of Rijeka, under the project number uniri-technic-18-200 “Failure analysis of materials in marine environment”.

Conflicts of Interest: The authors declare no conflict of interest. The funders had no role in the design of the study; in the collection, analyses, or interpretation of data; in the writing of the manuscript, or in the decision to publish the results.

References

1. Cejuela, E.; Negro, V.; del Campo, J.M. Evaluation and Optimization of the Life Cycle in Maritime Works. *Sustain.* **2020**, *12*, doi:10.3390/su12114524.
2. Tang, Y.; Sun, Z.; Wu, G. Compressive Behavior of Sustainable Steel-FRP Composite Bars with Different Slenderness Ratios. *Sustain.* **2019**, *11*, doi:10.3390/su11041118.
3. Mahdavi, G.; Nasrollahzadeh, K.; Hariri-Ardebili, M.A. Optimal FRP Jacket Placement in RC Frame Structures towards a Resilient Seismic Design. *Sustain.* **2019**, *11*, doi:10.3390/su11246985.
4. Pritchard, G. Reinforced Plastics Durability; Woodhead Publishing Limited: Cambridge, 1999; ISBN 0849305470.
5. Durability of Composites in a Marine Environment; Davies, P., Rajapakse, Y.D.S., Eds.; Solid Mechanics and Its Applications; Springer Netherlands: Dordrecht, 2014; Vol. 208; ISBN 978-94-007-7416-2.
6. Durability of Composites in a Marine Environment 2; Davies, P., Rajapakse, Y.D.S., Eds.; Solid Mechanics and Its Applications; Springer International Publishing: Cham, 2018; Vol. 245; ISBN 978-3-319-65144-6.
7. Martin, R. Ageing of Composites; Woodhead Publishing Limited: Cambridge England, 2008; ISBN 978-1-84569-352-7.
8. Irez, A.B.; Zambelis, G.; Bayraktar, E. A New Design of Recycled Ethylene Propylene Diene Monomer Rubber Modified Epoxy Based Composites Reinforced with Alumina Fiber: Fracture Behavior and Damage Analyses. *Materials (Basel)*. **2019**, *12*, 2729, doi:10.3390/ma12172729.
9. İREZ, A.B.; BAYRAKTAR, E. Design of Epoxy Modified Recycled Rubber-Based Composites: Effects of Different Contents of Nano-Silica, Alumina and Graphene Nanoplatelets Modification on the Toughening Behavior. *GAZI Univ. J. Sci.* **2020**, *33*, 188–199, doi:10.35378/gujs.585446.
10. Danilova, S.N.; Yarusova, S.B.; Kulchin, Y.N.; Zhevtun, I.G.; Buravlev, I.Y.; Okhlopko, A.A.; Gordienko, P.S.; Subbotin, E.P. UHMWPE/CaSiO₃ Nanocomposite: Mechanical and Tribological Properties. *Polymers (Basel)*. **2021**, *13*, 570, doi:10.3390/polym13040570.
11. Barsotti, B.; Gaiotti, M.; Rizzo, C.M. Recent Industrial Developments of Marine Composites Limit States and Design Approaches on Strength. *J. Mar. Sci. Appl.* **2020**, doi:10.1007/s11804-020-00171-1.
12. Vizinin, G.; Vukelic, G. Degradation and Damage of Composite Materials in Marine Environment. *Medziagotyra* **2019**, doi:10.5755/j01.ms.26.3.22950.
13. Morla, P.; Gupta, R.; Azarsa, P.; Sharma, A. Corrosion Evaluation of Geopolymer Concrete Made with Fly Ash and Bottom Ash. *Sustain.* **2021**, *13*, 1–16, doi:10.3390/su13010398.
14. Bond, D.A. Moisture Diffusion in a Fiber-Reinforced Composite: Part I - Non-Fickian Transport and the Effect of Fiber Spatial Distribution. *J. Compos. Mater.* **2005**, *39*, 2113–2142, doi:10.1177/0021998305052030.
15. Eftekhari, M.; Fatemi, A. Tensile Behavior of Thermoplastic Composites Including Temperature, Moisture, and Hygrothermal Effects. *Polym. Test.* **2016**, *51*, 151–164, doi:10.1016/j.polymertesting.2016.03.011.
16. Ounaies, M.; Harchay, M.; Dammak, F.; Daly, H. Ben Prediction of Hygrothermal Behavior of Polyester/Glass Fiber Composite in Dissymmetric Absorption. *J. Compos. Mater.* **2018**, *52*, 4001–4007, doi:10.1177/0021998318773458.

17. Bank, L.C.; Gentry, T.R.; Barkatt, A. Accelerated Test Methods to Determine the Long-Term Behavior of FRP Composite Structures: Environmental Effects. *J. Reinf. Plast. Compos.* 1995, 14, 559–587, doi:10.1177/073168449501400602.
18. Davies, P. Towards More Representative Accelerated Aging of Marine Composites. In *Advances in Thick Section Composite and Sandwich Structures*; Springer International Publishing: Cham, 2020; pp. 507–527.
19. de Souza Rios, A.; de Amorim, W.F.; de Moura, E.P.; de Deus, E.P.; de Andrade Feitosa, J.P. Effects of Accelerated Aging on Mechanical, Thermal and Morphological Behavior of Polyurethane/Epoxy/Fiberglass Composites. *Polym. Test.* 2016, 50, 152–163, doi:10.1016/j.polymertesting.2016.01.010.
20. Cysne Barbosa, A.P.; P. Fulco, A.P.; S.S. Guerra, E.; K. Arakaki, F.; Tosatto, M.; B. Costa, M.C.; D. Melo, J.D. Accelerated Aging Effects on Carbon Fiber/Epoxy Composites. *Compos. Part B Eng.* 2017, 110, 298–306, doi:10.1016/j.compositesb.2016.11.004.
21. Panaitescu, I.; Koch, T.; Archodoulaki, V.-M. Accelerated Aging of a Glass Fiber/Polyurethane Composite for Automotive Applications. *Polym. Test.* 2019, 74, 245–256, doi:10.1016/j.polymertesting.2019.01.008.
22. Helbling, C.S.; Karbhari, V.M. Investigation of the Sorption and Tensile Response of Pultruded E-Glass/Vinylester Composites Subjected to Hygrothermal Exposure and Sustained Strain. *J. Reinf. Plast. Compos.* 2008, 27, 613–638, doi:10.1177/0731684407081769.
23. Bian, L.; Xiao, J.; Zeng, J.; Xing, S. Effects of Seawater Immersion on Water Absorption and Mechanical Properties of GFRP Composites. *J. Compos. Mater.* 2012, 46, 3151–3162, doi:10.1177/0021998312436992.
24. Mayya, H.B.; Pai, D.; Kini, V.M.; N H, P. Effect of Marine Environmental Conditions on Physical and Mechanical Properties of Fiber-Reinforced Composites—A Review. *J. Inst. Eng. Ser. C* 2021, 102, 843–849, doi:10.1007/s40032-021-00676-w.
25. Joliff, Y.; Belec, L.; Chailan, J.F. Modified Water Diffusion Kinetics in an Unidirectional Glass/Fibre Composite Due to the Interphase Area: Experimental, Analytical and Numerical Approach. *Compos. Struct.* 2013, 97, 296–303, doi:10.1016/j.compstruct.2012.09.044.
26. Gellert, E.P.; Turley, D.M. Seawater Immersion Ageing of Glass-Fibre Reinforced Polymer Laminates for Marine Applications. *Compos. Part A Appl. Sci. Manuf.* 1999, 30, 1259–1265, doi:10.1016/S1359-835X(99)00037-8.
27. Vailati, M.; Mercuri, M.; Angiolilli, M.; Gregori, A. Natural-Fibrous Lime-Based Mortar for the Rapid Retrofitting of Masonry Heritage. *Preprints* 2021, doi:doi:10.20944/preprints202107.0431.v1.
28. Fan, Y.; Gomez, A.; Ferraro, S.; Pinto, B.; Muliana, A.; Saponara, V. La Diffusion of Water in Glass Fiber Reinforced Polymer Composites at Different Temperatures. *J. Compos. Mater.* 2019, 53, 1097–1110, doi:10.1177/0021998318796155.
29. Rubino, F.; Nisticò, A.; Tucci, F.; Carlone, P. Marine Application of Fiber Reinforced Composites: A Review. *J. Mar. Sci. Eng.* 2020, 8, 26, doi:10.3390/jmse8010026.
30. DNV GL AS DNVGL-ST-C501 Composite Components; 2017;
31. DNV-OS-C501 Composite Components. *Det Nor. Verit.* 2010, 119–134.
32. Lloyd's Register Guidance Notes for the Classification of Special Service Craft Calculation - Procedures for Composite Construction 2013.
33. INTERNATIONAL STANDARD ISO 527 Plastics - Determination of Tensile Properties; 2020; p. 14;

34. Milenkovic, S.; Slavkovic, V.; Fragassa, C.; Grujovic, N.; Palic, N.; Zivic, F. Effect of the Raster Orientation on Strength of the Continuous Fiber Reinforced PVDF/PLA Composites, Fabricated by Hand-Layup and Fused Deposition Modeling. *Compos. Struct.* 2021, 270, 114063, doi:10.1016/j.compstruct.2021.114063.
35. Institute of Oceanography and Fisheries Početna Procjena Stanja i Opterećenja Morskog Okoliša Hrvatskog Dijela Jadrana; Split, Croatia, 2012;
36. Belingardi, G.; Paolino, D.S.; Koricho, E.G. Investigation of Influence of Tab Types on Tensile Strength of E-Glass/Epoxy Fiber Reinforced Composite Materials. *Procedia Eng.* 2011, 10, 3279–3284, doi:10.1016/j.proeng.2011.04.541.
37. Davies, P.; MazÉas, F.; Casari, P. Sea Water Aging of Glass Reinforced Composites: Shear Behaviour and Damage Modelling. *J. Compos. Mater.* 2001, 35, 1343–1372, doi:10.1106/MNBC-81UB-NF5H-P3ML.
38. Siriruk, A.; Penumadu, D. Effect of Sea Water on Polymeric Marine Composites. In; Springer, Dordrecht, 2014; pp. 129–142.
39. José-Trujillo, E.; Rubio-González, C.; Rodríguez-González, J. Seawater Ageing Effect on the Mechanical Properties of Composites with Different Fiber and Matrix Types. *J. Compos. Mater.* 2019, 53, 3229–3241, doi:10.1177/0021998318811514.
40. Abdurohman, K.; Adhitya, M. Effect of Water and Seawater on Mechanical Properties of Fiber Reinforced Polymer Composites: A Review for Amphibious Aircraft Float Development. *IOP Conf. Ser. Mater. Sci. Eng.* 2019, 694, 012035, doi:10.1088/1757-899X/694/1/012035.
41. Barone, G.D.; Ferizović, D.; Biundo, A.; Lindblad, P. Hints at the Applicability of Microalgae and Cyanobacteria for the Biodegradation of Plastics. *Sustain.* 2020, 12, 1–15.
42. Bel Haj Frej, H.; Léger, R.; Perrin, D.; Ienny, P.; Gérard, P.; Devaux, J.-F. Recovery and Reuse of Carbon Fibre and Acrylic Resin from Thermoplastic Composites Used in Marine Application. *Resour. Conserv. Recycl.* 2021, 173, 105705, doi:10.1016/j.resconrec.2021.105705.

B. Marine Environment Induced Failure of FRP Composites Used in Maritime Transport

Goran Vizentin, Goran Vukelic

Abstract: Fiber reinforced polymer (FRP) composites are being extensively considered for construction of ships and marine structures. Due to harsh environmental operational conditions, failure prediction of such structures is an imperative in this industry sector. This paper presents the final results of a 2-year research of real marine environment induced changes of mechanical properties in FRP composites.

Realistic environmental input parameters for structural modeling of marine structures are crucial and can be obtained by conducting tests in real sea environment for prolonged periods, as opposed to usual accelerated laboratory experiments. In this research, samples of epoxy/glass and polyester/glass with various fiber layout configurations have been submerged under the sea for periods of 6, 12 and 24 months. An analysis of mass changes, marine microbiology growth, tensile strength and morphological structures of the coupons was performed and compared with samples exposed to room environment.

All samples exhibited an increase in mass due to seawater absorption and microorganism growth in the organic resins (matrix). The tensile strength loss variation through the periods of submersion showed a correlation with the fiber layout configuration. The results of optical and scanning electron microscopical investigation indicated significant matrix morphological changes primarily due to salt crystal formation and the impact of sea microorganisms embedding in and attaching to the resin.

The outcome of this research will be the basis for a set of realistic input parameters for a failure analysis numerical tool currently in development that can be applied for life-time behavior predictions of marine structures.

Keywords: composites; durability of composites; marine environment; FRP composites

1. Introduction

Fiber reinforced polymer (FRP) composites are used in the engineering constructions, whether as an exclusive option for construction [1] or as a combination with traditional materials, such as steel [2], concrete [3,4] or rock [5]. FRP composites are also finding their application in transportation industry, especially maritime, whether it be in construction of lightweight ship structures [6] or other marine structures [7]. The research in this field from the last couple of decades aims to merge the experimental and scientific knowledge obtained so far with the goal to develop prediction models that can be used to achieve sustainable and safe design of engineering structures [8–11]. Possibly the most important advantage of composite

materials is the adaptability to specific applications demands by defining layup sequences, number of plies, and fiber orientation in the load direction [12–14], what in turn makes them increasingly appealing to engineers when designing marine structures of complex shapes. As the application field for marine composites widens, the request for mechanical and environmental resilience rises. Limit stress states, durability and life span, failure modes, fracture toughness, fire resistance, and environment influence parameters are crucial for an efficient sustainable and secure design process for structures in this demanding industry sector [15–18].

Marine structural designers often find the micromechanics of composites to too complex and time-consuming and as a result this aspect remains left out during design. Therefore, the scientific research in this field of study should be aimed at simplifying the complex micromechanical level analysis and transform it into simple-to-use and time-saving engineering tools.

The current practice for obtaining data for composites failure is based on experiments. As experiments can be relatively expensive and microscale data are usually unavailable to shipbuilders, they often turn to data and models prescribed by rules and procedures, thus leading to empirical based design process of marine structures. All of this yields rules that are very conservative in formulating design requests, which in turn hinders optimal design of marine structures concerning failure mechanisms.

One of the most important parameters influencing the mechanical properties of composite materials in marine applications is the absorption of seawater [19,20] and negative influences polluted process waters from ship systems to constructive materials [21]. Previous research on change of mechanical properties in this kind of environment is based on immersing test samples, called coupons, in tanks or climate chambers [22–25] in laboratory conditions using accelerated procedures [26] to simulate 20+ years of expected lifespan of typical marine structures [27–29], as an effort to reduce the time of the test.

Water absorption tests are often done with tap water, demineralized water, or artificial seawater [30,31]. Such testing methodology does not yield long-term data pertaining to degradation of mechanical properties exposed to the marine environment. Furthermore, the effects of the moving seawater (waves, sea level

variations due to tides) and radically variant environmental effects that a typical marine vessel or structure are exposed to during their life cycle are not considered in accelerated ageing laboratory methods.

The absorption process of moisture and water of a composite has been found to be complex and dependent on various factors [32], such as resin type and curing characteristics, void content in the resin and resin fiber contact zones, resin/fiber volume fractions [33], fiber layout configuration [34], the manufacturing technique, etc., [35–37].

All this was motivation to concentrate the research presented here on the influence of absorbed water on marine composites in real-life conditions, not laboratory, by submerging the coupons in the sea for prolonged periods of 6, 12 and 24 months.

The dominant choice of composite materials in the civil sector of the marine vessels industries is glass fiber reinforced plastics (GRP), both for commercial and leisure vessels hulls [38], resulting in a more cost-effective product. Classification societies can be somewhat restrictive when it comes to allowing composites as structural material. The choice of fibers is restricted to E-glass or carbon fibers, whilst resins are limited to epoxy, polyester, or vinyl-ester.

2. Experimental investigation

2.1. Coupons materials, geometry and preparation

The ISO 527 standard series [39] was attained to in determining the geometry of the testing coupons as it prescribes the testing procedures for the determination of tensile properties of fiber-reinforced plastic composites, both unidirectional as well as isotropic and orthotropic FRP composites. In this research, standardized tensile testing coupons were produced as various combinations of continuous glass fibers layout with epoxy (Sicommin SR 8200 and SD 720 series hardener) and polyester resin (Reichhold POLYLITE 507-574) used as matrices. The resins mechanical properties are shown in Table 1, as provided by the manufacturers of each component.

UD stitched E-glass fiber matt fabric (Sicommin UDV600), with 594 g/m² ply specific area weight, was used. Four different layup configurations were chosen for both matrix/fiber combinations to evaluate mechanical properties deterioration in the

marine environment. The layup schematics are unidirectional with longitudinal fiber orientation (UD0) and two multidirectional (0/90 and 0/45/90 symmetrical), all according to standard notation for composite layup [40].

Table 1 Resin systems properties.

Property	Epoxy	Polyester
Tensile strength [MPa]	47	42
Elasticity modulus [MPa]	3,240	2,700
Glass transition temperature [°C]	50	55

Rectangular plates (300×450 mm) with the mentioned different layup schemes were produced for each of the material combinations using 8 plies of the UD fabric per plate. The epoxy/glass plates were produced by vacuum assisted infusion process, resulting in 3±0.3 mm thick plates. The infusion process proved problematic for the polyester resin as it was resulting in dry fibers on the tool surfaces, so the polyester/glass plates were finally produced by hand layup process, resulting in 5±0.5 mm thick plates.

The chosen coupon geometry is shown in Figure 1. The coupons were cut out of the plates on a waterjet cutting machine (OMAX Maxiém series). The cutting pressure was between 1,400 and 3,400 bar, with the average cutting speed of 1,187 mm/min.

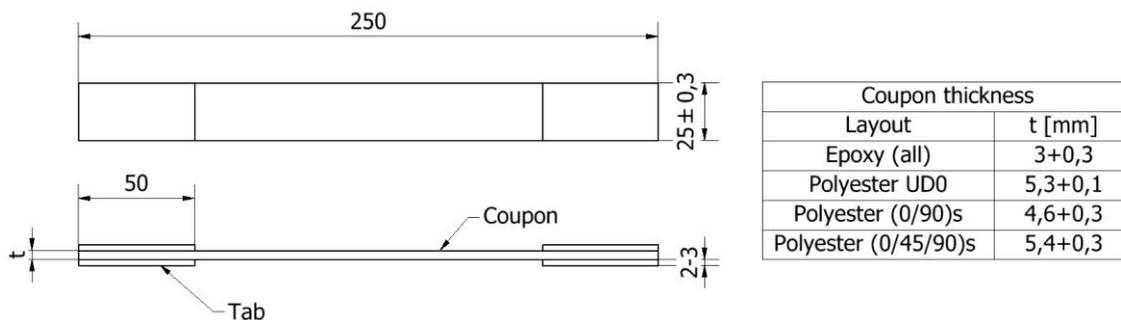

Fig. 1. Coupon geometry

Waterjet cutting takes advantage of the brittleness of composite materials as localized damage points on the locations of first contact of the cutting high-pressure waterjet with the material can be introduced precisely. The intent here is to introduce a point on the coupon in order to simulate real damage on marine structures. This damage point theoretically represents a facilitated entry point of seawater in a real marine structure on eventual damage spots that would occur during exploitation. Composite

marine vessels and structures are usually protected by a final layer of gel coat that protects them from water penetration. When this protective layer is damaged during application, a more significant sea water intake rate in the structure material is expected.

2.2. Exposure to real marine environment

All the coupons were weighed dry and measured with a ± 0.1 mm accuracy. The coupons were divided in groups of 5 pieces according fiber-matrix combinations (epoxy/glass, polyester/glass) and subdivided into 3 groups according the time of exposure to real marine environment (dry, 6 months, 12 months and 24 months). The “dry” groups were control ones, while the other two subgroups were exposed to real-life sea environment, i.e., submerged into the sea on a depth of 10 m, at northern Adriatic in front of the city of Rijeka in Croatia for a duration of 6, 12 and 24 months, respectively. The sea temperature at the location of experiment varies between 10–14 °C annually, salinity changes between 37.8–38.3 PPT, while the pH value is between 8.22–8.29 [41]. The coupons were mounted on special stainless-steel frames (AISI 316L).

2.3. Testing procedures

Each coupon was weighed with the same digital scale (200 g measuring range and 0.01 g resolution) as dry and after the submerging time-period to determine the mass gain of the absorbed seawater. Wet coupons were taken out of the sea, cleaned from sea organisms accumulated during submersion with a soft brush, still submerged in seawater. Special care was taken not to damage the coupon mechanically. After cleaning, the coupons were left to drain, dried superficially with a cloth, and weighed all in a period under one-minute total to assure maximal possible accuracy in measuring of the absorbed water amount.

The coupon ends were reinforced using end tabs before the tensile test to minimize the influence of the grips pressure on the test results [42]. The size of the tabs was chosen based on ISO 527-4 recommendations.

Quasi-static uniaxial tensile tests used for the determination of the material properties were performed on a Zwick 400 kN universal testing machine. A macro extensometer

was used to measure the specimens' elongation. The displacement rate of the testing machine crosshead during testing was 2 mm/min.

Tensile testing was conducted in accordance with ISO 527 series standards recommendations.

Microscopical investigation was performed on all fractured coupons. Surface and cross-sectional images were taken of all coupons, with special attention given to the grips areas and locations with observed damage after the tensile test

Optical microscopy systems (Olympus SZX10 stereo optical microscope and Olympus BX51 SM optical microscope analysis system, both produced by Olympus corporation, Japan) and scanning electron microscope (SEM, FEI QUANTA 250 FEG, FEI Company, USA) with the OXFORD INSTRUMENTS PENTAFET, UK, Energy Dispersive Spectroscopy (EDS) analysis module were used to investigate the state of the coupon's surfaces exposed to real sea environment and to identify changes in surface morphology caused by the exposure to seawater. Photographs were taken before and after the tensile tests.

3. Numerical investigation

The numerical investigation in this research was done in ANSYS software. The composite coupons layouts were modeled using the ACP (ANSYS Composite PrepPost) analysis system. The FE model was meshed using 4-node shell elements (ANSYS element designation SHELL181), in total comprising of 1034 nodes and 930 elements, as shown in figure 2. Each composite matrix-fiber layout configuration was defined in the ACP system.

The software's built in capability of determining the first ply failure (FPF) stress by composite failure criteria [43] was used to determine numerically the critical loads, i.e. the load at which the first failure occurs in any layer of the coupon FEM model. All of the included criteria indicators theories, namely maximum strain and stress, Tsai-Wu, Tsai-Hill, Hoffman, Hashin, Puck LaRC and Cuntze, were applied during analysis.

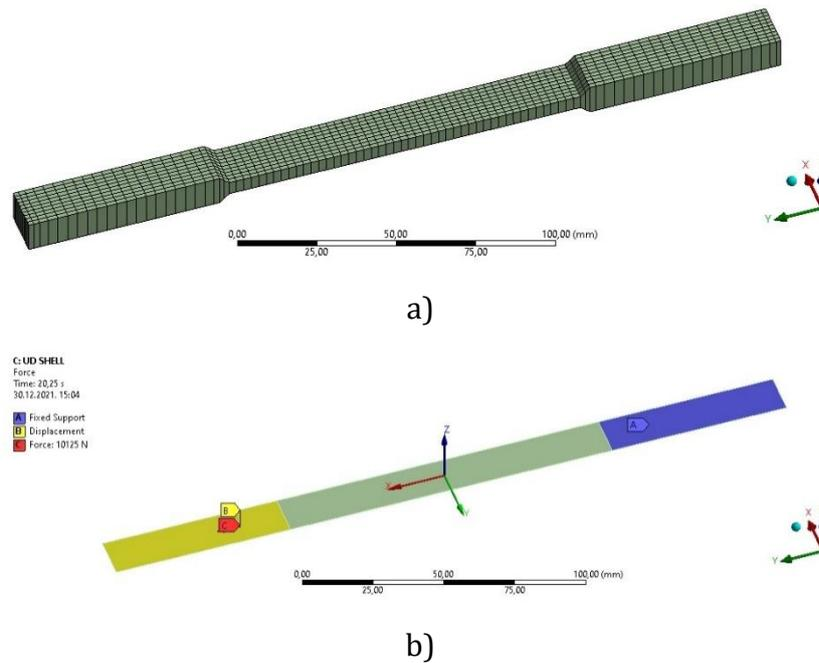

Fig. 2. Numerical analysis model: a) mesh, b) boundary conditions

The process was performed for each resin and fiber layout configurations for the dry coupons. In this work, the FPF critical stress was identified as the stress at which any of the composite layers exhibited a failure indicator factor value equal or greater than 1 for any of the failure criteria through the entire cross section of the said layer.

The load applied in the model was a longitudinal tensile linear step 25 kN force (50 increments of 500 N) at one end of the coupon, whilst the other ends degrees of freedom were fixed simulating the fixed grips and moving crosshead of the tensile testing machine. This intensity of the load was chosen based on the maximal tensile force values observed during experimental test results.

4. Results and discussion

The results of the experimental investigation of epoxy/glass and polyester/glass coupons exposed to marine environment are presented in the form of diagrams, images, and tables. Experimental testing results shown here are comprised of coupon weight change (seawater absorption, algae growth) analysis, tensile strength determination, and surface morphology changes observations. The results of the numerical investigation are presented in the form of table data and images.

Finally, the results obtained by the numerical investigation are compared with experimental results.

4.1. Experimental investigation results

4.1.1. Optical analysis

Exemplary images of attached bio organisms after 24 months of submersion are shown in Figure 3.



a)



b)



c)

Fig. 3. Attached bio-growth after 24 months: a) entire coupon, b) detail optical zoom 3×; c) detail optical zoom 10×

4.1.2. Mass gain - algae and marine organisms' growth and water intake

The average aggregate mass gain due to the coupled algae/marine organisms' growth and water absorption and only water absorption for the two matrix resin coupons is given in Figure 4, where the denotations E and PE stand for epoxy and polyester resin respectively, while the numbers 6, 12 and 24 indicate the period of submersion in months.

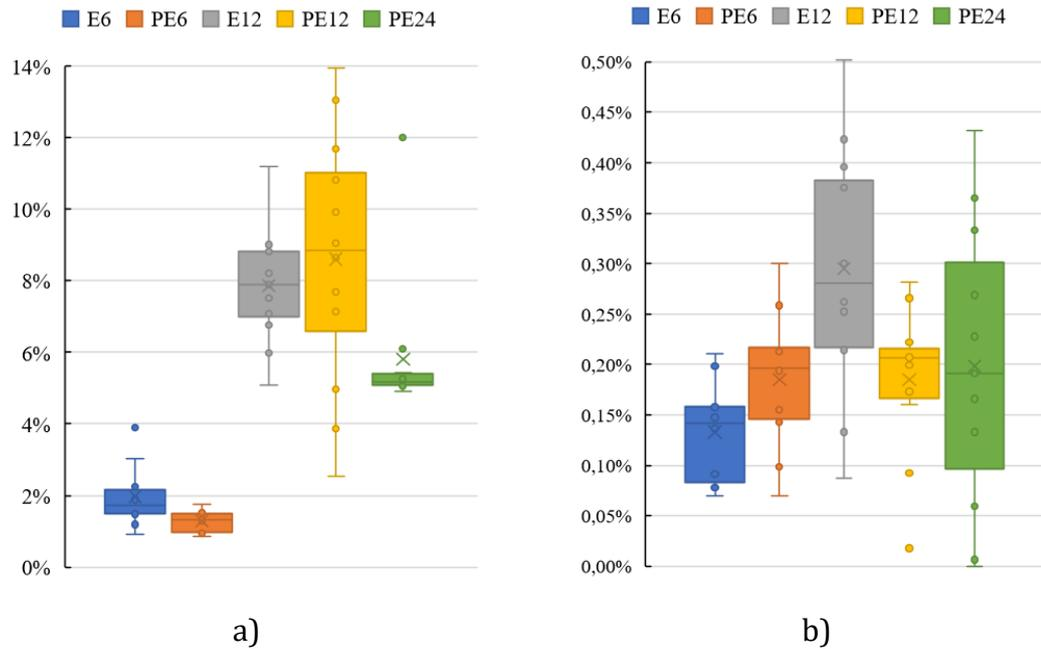
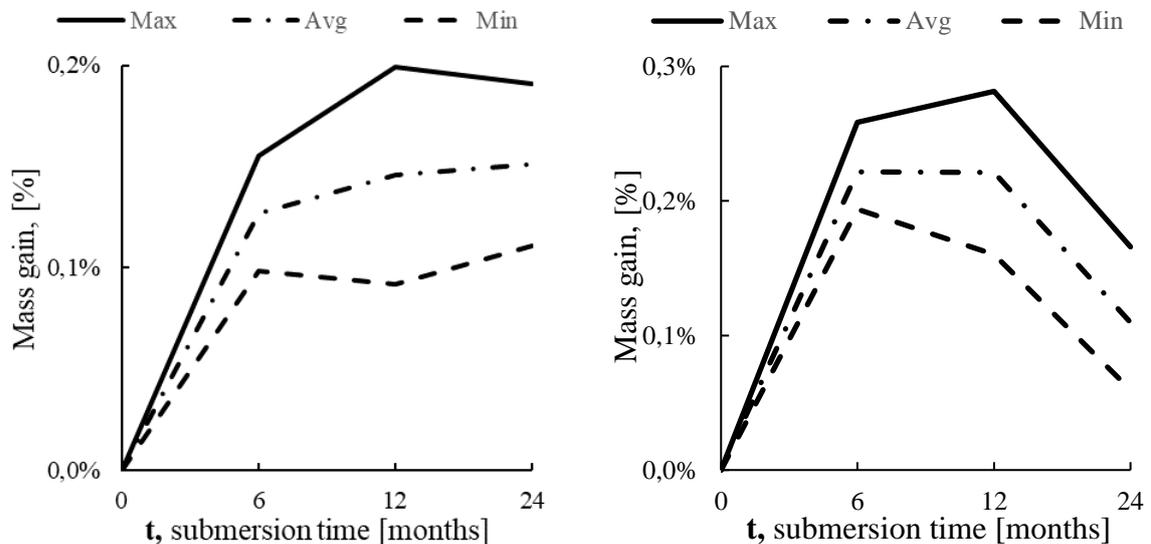

Fig. 4. Mass gain due (a) bio growth and water absorption; (b) only water absorption.

The variations of mass gain due to only the seawater absorption in respect to the fiber layout configuration of the polyester matrix coupons is given in Figure 5.



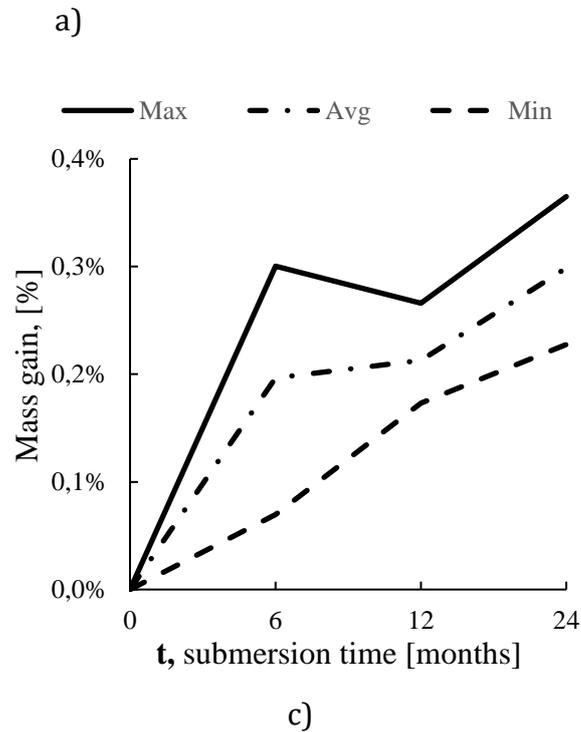

Fig. 5. Mass gain due to sea water absorption, polyester coupons: (a) UD0°; (b) (0/90)s; (c) (0/45/90)s coupons

4.1.3. Tensile test results

Engineering stress-strain diagrams were obtained from performed uniaxial tensile strength on dry coupons and wet coupons that were submerged in the sea for 6, 12 and 24 months. The change in tensile strength due to the prolonged submersion in seawater is shown in Figure 6.

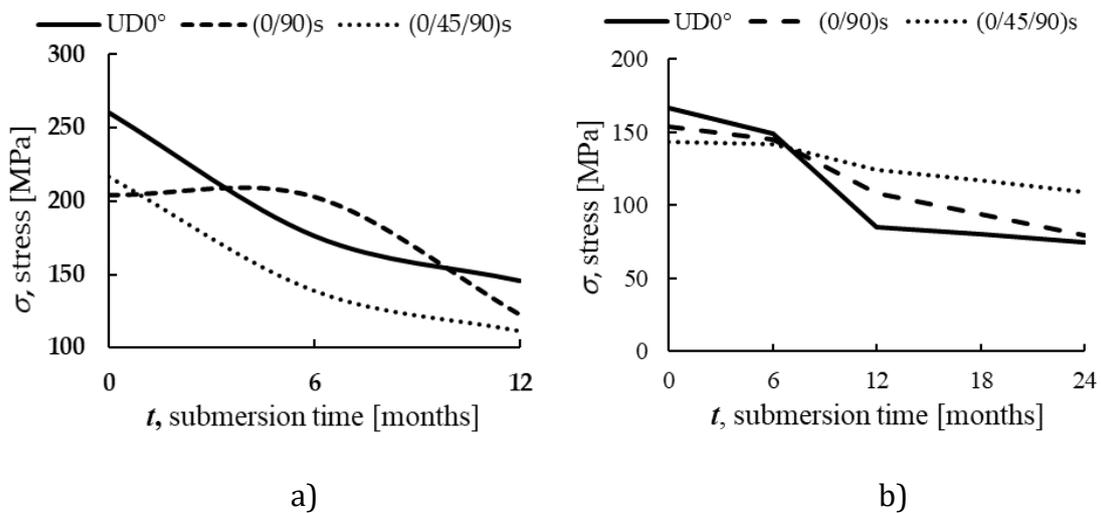

Fig6. Average tensile strength degradation: (a) epoxy resin coupons; (b) polyester resin coupons.

4.1.4. Microscopical investigation

Surface and cross-sectional images obtained by optical microscopy are not presented here but are available in a publicly accessible repository to save paper space and keep the readers focus on the more detailed and more illustrative SEM results.

The images obtained by SEM investigation are presented in Figures 7 and 8. Only some representative images were chosen as a portrayal of the performed research to limit the length of the paper, whilst the complete set of all obtained images is posted on an online repository as supplementary material to this article.

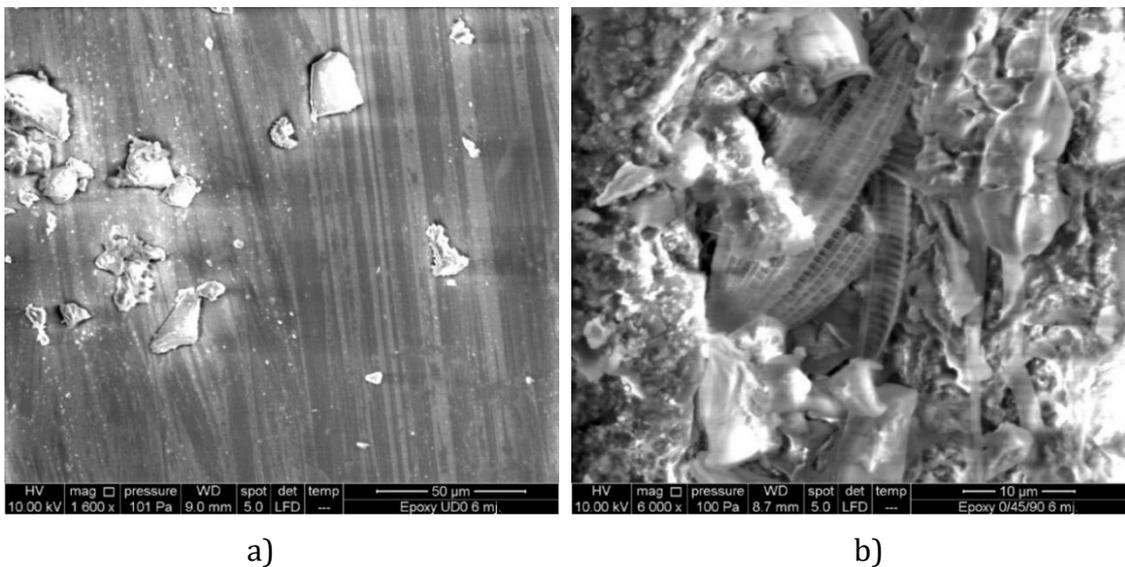

Fig7. Epoxy coupons: (a) salt crystals; (b) embedded microbes.

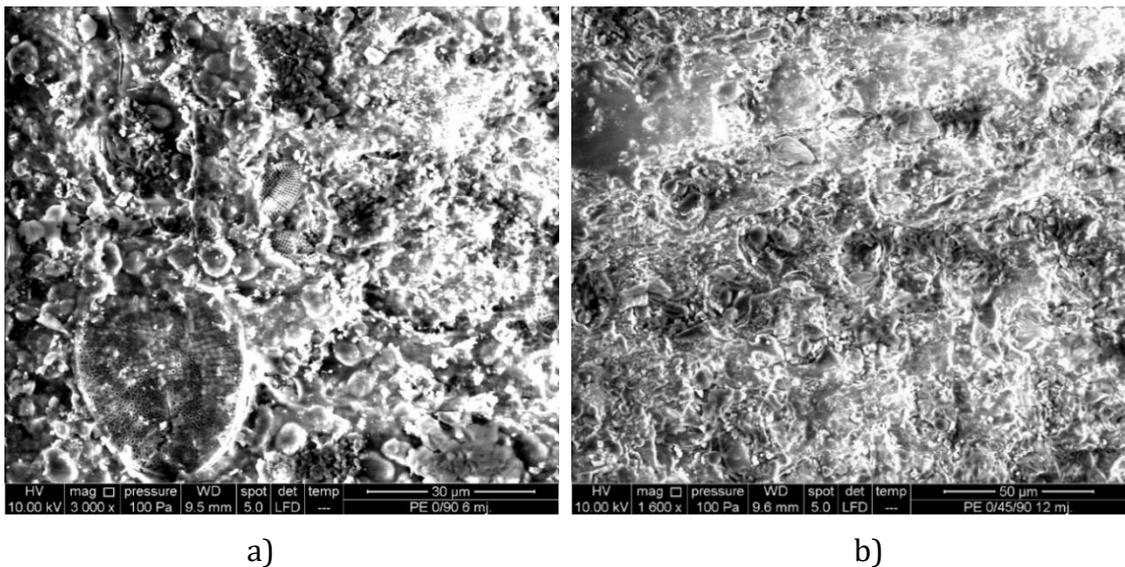

Fig 8. Polyester coupons: (a) embedded microbes; (b) matrix structure deterioration.

4.2. Numerical investigation results

The numerical and experimental analysis results for the dry epoxy matrix coupons are compared in table 2. The comparison shows good correlation of experimental and numerical procedures results with the exception of the (0/45/90)s fiber layout configuration. This discrepancy will be the subject of the authors further research.

Table 2 Experimental and numerical results comparison, epoxy matrix, dry coupons.

Fiber layout configuration	Tensile test		FEM model		Difference	
	[MPa]		[MPa]		[%]	
	Min	Max	Value	Criteria (layer)	Min	Max
UD0°	250,54	270,32	272,45	Tsai-Hill (4)	1	8
(0/90)s	178,33	205,31	172,55	Tsai-Hill (7)	3	19
(0/45/90)s	202,83	230,38	174,37	Tsai-Hill (5)	16	32

Figure 9 shows the stress distribution through the coupon for the UD0 fiber layout configuration.

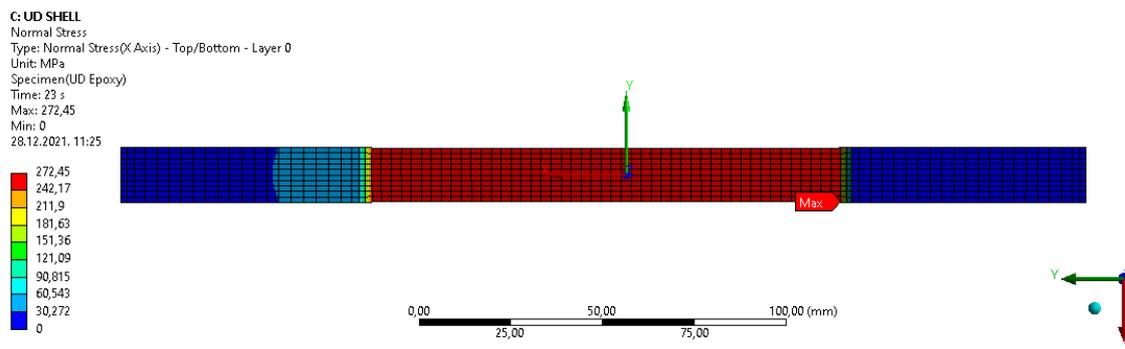

a)

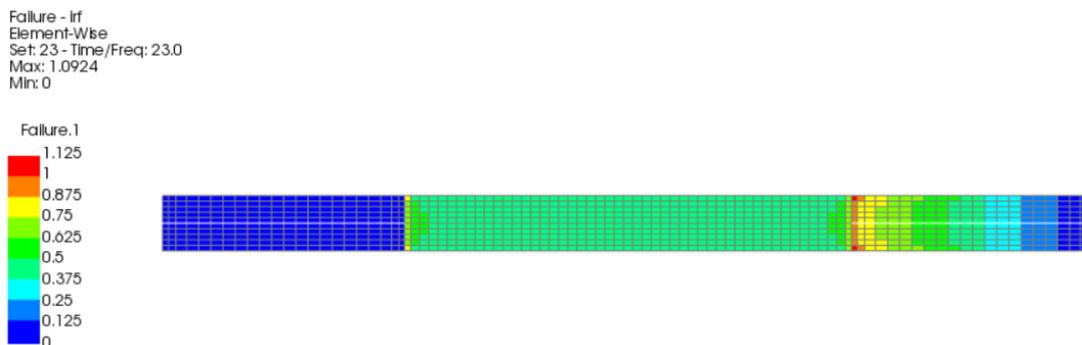

b)

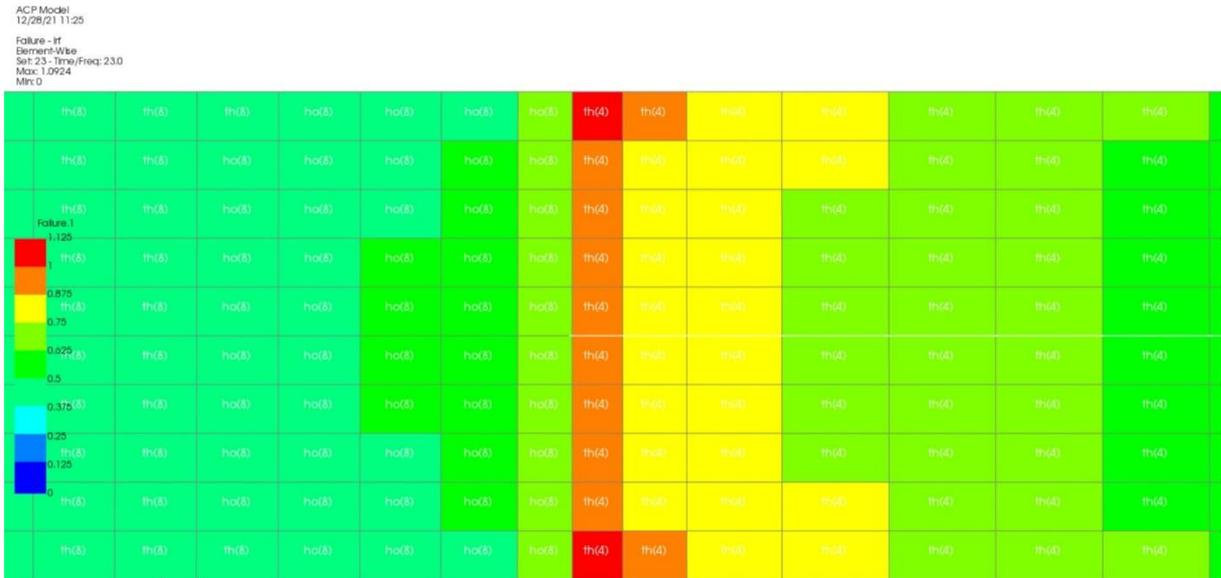

c)

Fig 9. Numerical analysis results epoxy UD coupon: a) stress distribution; b) failure index distribution; c) failure index distribution detail

The numerical and experimental analysis results for the polyester matrix coupons are compared in table 3. In this case, the comparison shows good correlation of experimental and numerical procedures results with the exception of the UD0 fiber layout configuration for which the numerical analysis results in a significant overestimation of the tensile stress. The identification of the reasons for this deviation will be subject of future investigation.

Table 3 Experimental and numerical results comparison, polyester matrix, dry coupons.

Fiber layout configuration	Tensile test		FEM model		Difference	
	[MPa]		[MPa]		[%]	
	Min	Max	Min	Criteria (layer)	Min	Max
UD0°	157,23	175,92	242,55	Tsai-Hill (4)	27	35
(0/90)s	137,48	169,25	165,69	Tsai-Hill (13)	2	17
(0/45/90)s	140,37	146,64	152,07	Tsai-Hill (7)	4	8

Figure 10 shows the stress distribution through the coupon for the (0/45/90)s fiber layout configuration.

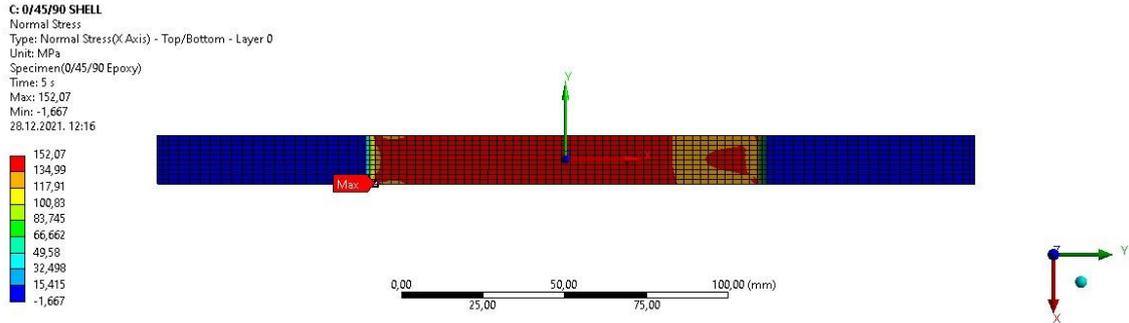

a)

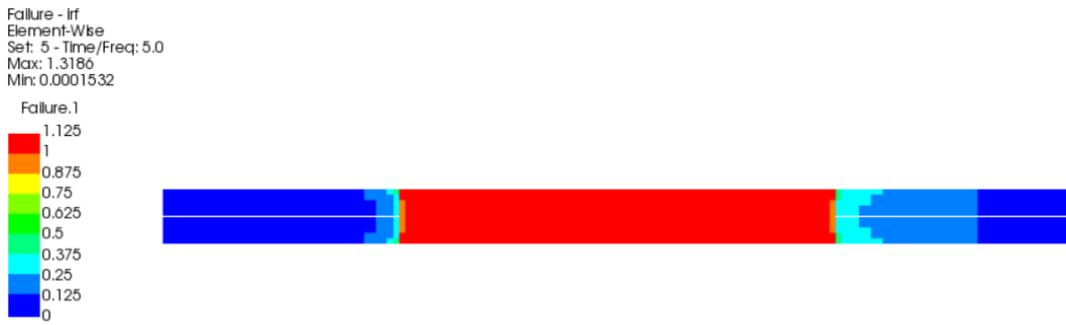

b)



c)

Fig 10. Numerical analysis results polyester (0/45/90)s coupon: a) stress distribution; b) failure index distribution; c) failure index distribution detail

5. Conclusion

The real sea environment has considerable effects on composite materials in the form of reduced mechanical strength for the tested coupons submerged in the sea. The submerged UD0, (0/90)s, and (0/45/90)s epoxy/glass coupons exhibited tensile strength reduction of 32%, 14%, and 36% after 6 months of submersion (with the exception of one inadequately manufactured (0/90)s coupon), whilst 44%, 40%, and 49% after 12 months of submersion, respectively. The polyester/glass UD0, (0/90)s, and (0/45/90)s coupons have lost 11%, 5%, and 1% after 6 months of submersion, 50%, 37%, and 13% after 12 months in the sea and 55%, 48% and 24% after 24 months of marine environment exposure. The (0/45/90)s layout configuration for the polyester/glass combination showed the greatest resilience to the marine environment. The research indicated that further study is needed here because the polyester coupons were made by hand-layup process, which can significantly affect mechanical characteristics of the composite. The numerical analysis results for (0/45/90)s epoxy and UD0 polyester coupons have shown discrepancies in comparison to experimental results. All of these issues will be addressed more in detail during future research.

The growth of microorganisms embedded in the resin and invertebrate (Nematoda) organism attached to the surface of the coupons effectively created voids in the matrix resin and produced a direct effect on mechanical properties. The mechanism of this effects needs deeper analysis and research. The findings of the research indicate the importance of biofouling in environmental degradation of mechanical properties of composite materials in the marine environment. The main goal of this research remains the development of a reliable predictive numerical model of the mechanical behavior of composite materials exposed to real sea environment, which would represent a basic tool to assess the durability of composite marine structures during their exploitation. Research findings can be useful in design process of composite marine structures or in use of composite for repair of already damaged structures [44–46]. In order to fully understand the effect of exposure effect on the composites, a continuation of the research is needed for even longer exposure of the composite material to sea environment. This additional set of data will help in building a predictive numerical model that could successfully replace the time and resource

consuming experiments which is a next step of this research. However, the stochastic nature of the environmental loading must be incorporated in that model [47]. For that reason, placing coupons in different types of marine environment (regarding the temperature, salinity, pH value, etc.) would bring even better accuracy of the numerical model.

Acknowledgements: This work has been supported by the University of Rijeka within the project uniri-technic-18-200 "Failure analysis of materials in marine environment".

Supplementary material: The complete set of SEM images obtained during this research is available on Vizentin, Goran (2021), "Marine Composites SEM", Mendeley Data, V1, doi: 10.17632/j8tvmkpmwf.1

References

- [1] E. Cejuela, V. Negro, J.M. del Campo, Evaluation and optimization of the life cycle in maritime works, *Sustain.* 12 (2020). <https://doi.org/10.3390/su12114524>.
- [2] R. Balokhonov, A. Zemlianov, V. Romanova, R. Bakeev, E. Evtushenko, Computational analysis of the influence of thermal residual stresses on the strength of metal-matrix composites, *Procedia Struct. Integr.* 31 (2021) 58–63. <https://doi.org/10.1016/j.prostr.2021.03.025>.
- [3] I. Kožar, N. Torić Malić, D. Simonetti, Ž. Smolčić, Bond-slip parameter estimation in fiber reinforced concrete at failure using inverse stochastic model, *Eng. Fail. Anal.* 104 (2019) 84–95. <https://doi.org/10.1016/j.engfailanal.2019.05.019>.
- [4] E. Kormanikova, M. Zmindak, P. Novak, P. Sabol, Tensile properties of carbon fiber reinforced polymer matrix composites: Application for the strengthening of reinforced concrete structure, *Compos. Struct.* 275 (2021) 114448. <https://doi.org/10.1016/j.compstruct.2021.114448>.
- [5] I. Andrezza, V. Infante, M.B. Garcia, P. Amaral, Flexural fatigue behaviour of an asymmetric sandwich composite made of limestone and cork agglomerate, *Int. J. Fatigue.* 130 (2020) 105264. <https://doi.org/10.1016/j.ijfatigue.2019.105264>.
- [6] I. Diez de Ulzurrun, F. López, M.A. Herreros, J.C. Suárez, Tests of deck-to-hull adhesive joints in GFRP boats, *Eng. Fail. Anal.* 14 (2007) 310–320. <https://doi.org/10.1016/j.engfailanal.2006.02.012>.
- [7] M.M. Watanabe Junior, J.M.L. Reis, H.S. da Costa Mattos, Polymer-based composite repair system for severely corroded circumferential welds in steel pipes, *Eng. Fail. Anal.* 81 (2017) 135–144. <https://doi.org/10.1016/j.engfailanal.2017.08.001>.

- [8] P. Davies, Y.D.S. Rajapakse, eds., *Durability of Composites in a Marine Environment*, Springer Netherlands, Dordrecht, 2014. <https://doi.org/10.1007/978-94-007-7417-9>.
- [9] P. Davies, Y.D.S. Rajapakse, eds., *Durability of Composites in a Marine Environment 2*, Springer International Publishing, Cham, 2018. <https://doi.org/10.1007/978-3-319-65145-3>.
- [10] R. Martin, *Ageing of composites*, Woodhead Publishing Limited, Cambridge England, 2008. <https://doi.org/10.1533/9781845694937>.
- [11] L. Takacs, L. Kovacs, T. Olajos, Numerical tool with mean-stress correction for fatigue life estimation of composite plates, *Eng. Fail. Anal.* 111 (2020) 104456. <https://doi.org/10.1016/j.engfailanal.2020.104456>.
- [12] M. Gljušćić, M. Franulović, D. Lanc, Ž. Božić, Digital image correlation of additively manufactured CFRTP composite systems in static tensile testing, *Procedia Struct. Integr.* 31 (2021) 116–121. <https://doi.org/10.1016/j.prostr.2021.03.019>.
- [13] M. Brčić, S. Krščanski, J. Brnić, Rotating Bending Fatigue Analysis of Printed Specimens from Assorted Polymer Materials, *Polymers (Basel)*. 13 (2021) 1020. <https://doi.org/10.3390/polym13071020>.
- [14] K. Venkatesan, K. Ramanathan, R. Vijayanandh, S. Selvaraj, G. Raj Kumar, M. Senthil Kumar, Comparative structural analysis of advanced multi-layer composite materials, *Mater. Today Proc.* 27 (2020) 2673–2687. <https://doi.org/10.1016/j.matpr.2019.11.247>.
- [15] G. Kastratović, A. Grbović, A. Sedmak, Ž. Božić, S. Sedmak, Composite material selection for aircraft structures based on experimental and numerical evaluation of mechanical properties, *Procedia Struct. Integr.* 31 (2021) 127–133. <https://doi.org/10.1016/j.prostr.2021.03.021>.
- [16] J. Sousa, J. Marques, M. Garcia, V. Infante, P. Amaral, Mechanical characterization of sandwich composites with embedded sensors, *Eng. Fail. Anal.* 117 (2020) 104765. <https://doi.org/10.1016/j.engfailanal.2020.104765>.
- [17] M. Tomasz, D. Szymon, B. Bartosz, W. Joanna, Z. Paweł, L. Grzegorz, Flexural and compressive residual strength of composite bars subjected to harsh environments, *Eng. Fail. Anal.* 133 (2022) 105958. <https://doi.org/10.1016/j.engfailanal.2021.105958>.
- [18] G. Vizentin, D. Glujić, V. Špada, Effect of Time-Real Marine Environment Exposure on the Mechanical Behavior of FRP Composites, *Sustainability*. 13 (2021) 9934. <https://doi.org/10.3390/su13179934>.
- [19] G. Vizentin, G. Vukelic, Degradation and damage of composite materials in marine environment, *Medziagotyra*. (2019). <https://doi.org/10.5755/j01.ms.26.3.22950>.
- [20] S. Tamboura, A. Abdessalem, J. Fitoussi, H. Ben Daly, A. Tcharkhtchi, On the mechanical properties and damage mechanisms of short fibers reinforced composite submitted to hydrothermal aging: Application to sheet molding compound composite, *Eng. Fail. Anal.* 131 (2022) 105806. <https://doi.org/10.1016/j.engfailanal.2021.105806>.

-
- [21] N.H. Padmaraj, K.M. Vijaya, Shreepannaga, U. Amritha, P. Dayananda, Slurry erosion behaviour of carbon/epoxy quasi-isotropic laminates based on Taguchi's optimization method, *Eng. Fail. Anal.* 123 (2021) 105274. <https://doi.org/10.1016/j.engfailanal.2021.105274>.
- [22] P. Davies, Towards More Representative Accelerated Aging of Marine Composites, in: *Adv. Thick Sect. Compos. Sandw. Struct.*, Springer International Publishing, Cham, 2020: pp. 507–527. https://doi.org/10.1007/978-3-030-31065-3_17.
- [23] A. de Souza Rios, W.F. de Amorim, E.P. de Moura, E.P. de Deus, J.P. de Andrade Feitosa, Effects of accelerated aging on mechanical, thermal and morphological behavior of polyurethane/epoxy/fiberglass composites, *Polym. Test.* 50 (2016) 152–163. <https://doi.org/10.1016/j.polymertesting.2016.01.010>.
- [24] A.P. Cysne Barbosa, A.P. P. Fulco, E. S.S. Guerra, F. K. Arakaki, M. Tosatto, M.C. B. Costa, J.D. D. Melo, Accelerated aging effects on carbon fiber/epoxy composites, *Compos. Part B Eng.* 110 (2017) 298–306. <https://doi.org/10.1016/j.compositesb.2016.11.004>.
- [25] I. Panaitescu, T. Koch, V.-M. Archodoulaki, Accelerated aging of a glass fiber/polyurethane composite for automotive applications, *Polym. Test.* 74 (2019) 245–256. <https://doi.org/10.1016/j.polymertesting.2019.01.008>.
- [26] P. Morla, R. Gupta, P. Azarsa, A. Sharma, Corrosion evaluation of geopolymer concrete made with fly ash and bottom ash, *Sustain.* 13 (2021) 1–16. <https://doi.org/10.3390/su13010398>.
- [27] D.A. Bond, Moisture diffusion in a fiber-reinforced composite: Part I - Non-Fickian transport and the effect of fiber spatial distribution, *J. Compos. Mater.* 39 (2005) 2113–2142. <https://doi.org/10.1177/0021998305052030>.
- [28] M. Eftekhari, A. Fatemi, Tensile behavior of thermoplastic composites including temperature, moisture, and hygrothermal effects, *Polym. Test.* 51 (2016) 151–164. <https://doi.org/10.1016/j.polymertesting.2016.03.011>.
- [29] H.S. da Costa Mattos, J.M.L. Reis, F.C. Amorim, J.F.S. Brandao, L.D.M. Lana, V.A. Perrut, Long-term field performance of a composite pipe repair under constant hydrostatic pressure, *Eng. Fail. Anal.* 130 (2021) 105765. <https://doi.org/10.1016/j.engfailanal.2021.105765>.
- [30] C.S. Helbling, V.M. Karbhari, Investigation of the Sorption and Tensile Response of Pultruded E-Glass/Vinylester Composites Subjected to Hygrothermal Exposure and Sustained Strain, *J. Reinf. Plast. Compos.* 27 (2008) 613–638. <https://doi.org/10.1177/0731684407081769>.
- [31] L. Bian, J. Xiao, J. Zeng, S. Xing, Effects of seawater immersion on water absorption and mechanical properties of GFRP composites, *J. Compos. Mater.* 46 (2012) 3151–3162. <https://doi.org/10.1177/0021998312436992>.
- [32] H.B. Mayya, D. Pai, V.M. Kini, P. N H, Effect of Marine Environmental Conditions on Physical and Mechanical Properties of Fiber-Reinforced Composites—A Review, *J. Inst. Eng. Ser. C.* 102 (2021) 843–849. <https://doi.org/10.1007/s40032-021-00676-w>.

- [33] Y. Joliff, L. Belec, J.F. Chailan, Modified water diffusion kinetics in an unidirectional glass/fibre composite due to the interphase area: Experimental, analytical and numerical approach, *Compos. Struct.* 97 (2013) 296–303. <https://doi.org/10.1016/j.compstruct.2012.09.044>.
- [34] S.A. Setyabudi, M.A. Chiron, A. Purnowidodo, Effect of angle orientation lay-up on uniaxial tensile test specimen of Fiber carbon composite manufactured by using resin transfer moulding with vacuum bagging, *IOP Conf. Ser. Mater. Sci. Eng.* 494 (2019) 012020. <https://doi.org/10.1088/1757-899X/494/1/012020>.
- [35] E.P. Gellert, D.M. Turley, Seawater immersion ageing of glass-fibre reinforced polymer laminates for marine applications, *Compos. Part A Appl. Sci. Manuf.* 30 (1999) 1259–1265. [https://doi.org/10.1016/S1359-835X\(99\)00037-8](https://doi.org/10.1016/S1359-835X(99)00037-8).
- [36] A. Vailati, M.; Mercuri, M.; Angiolilli, M.; Gregori, Natural-Fibrous Lime-Based Mortar for the Rapid Retrofitting of Masonry Heritage, *Preprints.* (2021). <https://doi.org/doi:10.20944/preprints202107.0431.v1>.
- [37] Y. Fan, A. Gomez, S. Ferraro, B. Pinto, A. Muliana, V. La Saponara, Diffusion of water in glass fiber reinforced polymer composites at different temperatures, *J. Compos. Mater.* 53 (2019) 1097–1110. <https://doi.org/10.1177/0021998318796155>.
- [38] F. Rubino, A. Nisticò, F. Tucci, P. Carlone, Marine Application of Fiber Reinforced Composites: A Review, *J. Mar. Sci. Eng.* 8 (2020) 26. <https://doi.org/10.3390/jmse8010026>.
- [39] INTERNATIONAL STANDARD, ISO 527 Plastics - Determination of tensile properties, 2020.
- [40] S. Milenkovic, V. Slavkovic, C. Fragassa, N. Grujovic, N. Palic, F. Zivic, Effect of the raster orientation on strength of the continuous fiber reinforced PVDF/PLA composites, fabricated by hand-layup and fused deposition modeling, *Compos. Struct.* 270 (2021) 114063. <https://doi.org/10.1016/j.compstruct.2021.114063>.
- [41] Institute of Oceanography and Fisheries, Početna procjena stanja i opterećenja morskog okoliša hrvatskog dijela Jadrana, Split, Croatia, 2012.
- [42] G. Belingardi, D.S. Paolino, E.G. Koricho, Investigation of influence of tab types on tensile strength of E-glass/epoxy fiber reinforced composite materials, *Procedia Eng.* 10 (2011) 3279–3284. <https://doi.org/10.1016/j.proeng.2011.04.541>.
- [43] N. Rahimi, M.A. Rahim, A.K. Hussain, J. Mahmud, Evaluation of failure criteria for composite plates under tension, in: 2012 IEEE Symp. Humanit. Sci. Eng. Res., IEEE, 2012: pp. 849–854. <https://doi.org/10.1109/SHUSER.2012.6269001>.
- [44] G. Vukelic, G. Vizentin, Z. Bozic, L. Rukavina, Failure analysis of a ruptured compressor pressure vessel, *Procedia Struct. Integr.* 31 (2021) 28–32. <https://doi.org/10.1016/j.prostr.2021.03.006>.
- [45] G. Vukelic, G. Vizentin, Composite wrap repair of a failed pressure vessel — Experimental and numerical analysis, *Thin-Walled Struct.* 169 (2021) 108488. <https://doi.org/10.1016/j.tws.2021.108488>.

- [46] J. Lukács, Z. Koncsik, P. Chován, Integrity reconstruction of damaged transporting pipelines applying fiber reinforced polymer composite wraps, *Procedia Struct. Integr.* 31 (2021) 51–57. <https://doi.org/10.1016/j.prostr.2021.03.009>.
- [47] I. Kožar, N. Torić Malić, D. Simonetti, Ž. Božić, Stochastic properties of bond-slip parameters at fibre pull-out, *Eng. Fail. Anal.* 111 (2020) 104478. <https://doi.org/10.1016/j.engfailanal.2020.104478>.

C. Prediction of FRP Composites Properties Deterioration Induced by Marine Environment

Goran Vizentin and Goran Vukelic

Abstract: A model for prediction of fatigue life degradation of fiber reinforced (FRP) composite material exposed for prolonged periods to real marine environment is proposed. The data collected during previous phases of a more comprehensive research of real marine environment induced changes of mechanical properties in FRP composites was used to assess the influence of these changes on the durability characteristic of composites. Attention has been given to classification societies design and exploitation rules in this matter. The need for modification of the composite material S-N curves obtaining process, considering the marine environment influence has been considered. Regression analysis of the experimental data has been conducted, resulting in a mathematical strength degradation in time model. The regression analysis has shown an acceptable correlation value. S-N curves for E-glass/polyester composite with three different fiber layout configurations have been evaluated and modified in order to encompass the findings of the research.

Keywords: composites; marine environment; material degradation; fatigue life

1. Introduction

Fiber reinforced polymer (FRP) composites are becoming ever more accepted materials in almost every industry sector either for entire structures [1,2] or in combination with other, so-called traditional materials [3–5]. The marine industry sector is no exception to this trend [6], as FRP composites are finding their application in transportation industry, especially maritime, whether it be in construction of lightweight ship structures [7,8] or other marine structures [9,10].

A number of researches in this field from the last couple of decades aimed to consolidate the experimental and scientific knowledge obtained so far with the goal to develop prediction models that can be used to achieve sustainable and safe design of engineering structures [11–14]. Likely the most important advantage of composite materials is the adaptability to specific applications demands by defining layup sequences, number of plies, and fiber orientation in the principal loading directions [15–17]. Such flexibility in application makes FRP composites increasingly appealing to engineers when designing marine structures of complex shapes. As the application field for marine composites widens, the request for mechanical and environmental resilience rises. Limit stress states, durability and life span, failure modes, fracture

toughness, fire resistance, and environment influence parameters are crucial for an efficient sustainable and secure design process for structures in this demanding industry sector [18–21].

In practice, marine structural designers tend to avoid micromechanics of composite as it can be too convoluted and tedious for everyday use resulting in ignoring this aspect in the design process and turning to rules and procedures which can be conservative, empirical and not completely encompass all the specificities of newly emerging materials such as FRP composites. The design results are consequently often not optimal for failure modelling. It is up to the scientists in this field of study to define, develop and produce simple engineering tools to better the design process.

The dominating methods for composite failure data collection are experiment based. The main downside is the cost and time needed for such experiments if all the aspects of real marine environments are to be taken into consideration. The dominant parameters influencing the mechanical properties of composite materials in marine applications is the absorption of seawater [22,23] and the negative effects of polluted process waters from ship systems to constructive materials [24].

The prevailing composite chosen as constructive material in the civil sector of the marine industry, equally for commercial and small hull vessels, is glass fiber reinforced plastics [25]. This choice is the result of the favorable material characteristics yielding a more cost-effective product. The strict rules, standards and recommended practices of the classification societies restrict the choice in matrix and fiber materials if it is to be used in marine structures down to E-glass or carbon fibers and epoxy, polyester, or vinyl-ester resins [26]. The same standard dictates that the effect on the “properties under long term static and cyclic and high rate loads” and the “influence of the environment on properties” must be considered during the design process of marine structures.

The regulations acknowledge that material properties can “change gradually with time and long exposure times” and that significant changes can occur after one year but neglect to consider the real marine environment influences. Only the effects of seawater and fresh water are mentioned, stating that fresh water has more severe effects on the composite mechanical properties than the seawater. Furthermore, any marine structure is subjected to actions of fouling marine organisms, which has not

been described in the standards regarding to design of the structure but is considered separately (protection coatings, anti-fouling devices etc.).

Fatigue of composites immersed in water has been investigated in the past [27,28]. Early research has assumed that the absorbed moisture has no influence on the material fatigue strength in sinusoidal tension conditions with a moisture content not greater than 0.2 per cent [29]. Newer research however acknowledges the effects of water absorption on fatigue strength of composites [30,31]. Phenomenological base fatigue life model of glass fiber reinforced polymer composite materials has also been proposed [32]. Researchers have also tried to simplify this complex problem to facilitate engineering application of fatigue life calculations [33]

Some research has been done taking into account the protective gel coat influence on fatigue of glass polyester composites [34], concluding that polyester content is the only determinative factor for fatigue strength, while both polyester and gelcoat contents are effective for tensile strength. A comprehensive review for S-N curve models for composite materials characterization [35] indicated which S-N curve models have the highest fitting capabilities for experimental fatigue data.

Nonetheless, the research presented in this paper aims to encompass the real marine environment effects, including the effects of moving seawater (waves, tidal changes), weather influences and the impact of the marine organisms that live attached to any and all typical marine structures. All of these effects are difficult if not impossible to achieve in laboratory conditions.

2. Materials and Methods

2.1. Experimental investigation

The analysis of the data collected during the experimental testing phase of the research (250x25x5 mm coupons, 50±5% fiber reinforcement volume) [21,36] has shown the influence of the real sea environment on epoxy/glass and polyester/glass composite materials (with 3 distinct fiber layout configurations, namely unidirectional UD0°, cross ply (0/90)s and (0/45/90)s) in the form of reduced mechanical strength for the material submerged in the sea. The marine microorganisms embedded in the resin and invertebrates attached to the surface of the material have been identified as

a factor of influence on the composite's mechanical properties. The mechanism (or mechanisms) of the effects that these organisms exert on the material structure needs deeper analysis and research. Nonetheless, the importance of testing in real marine environment instead of laboratory conditions has become evident. The various marine organisms and microorganisms attached to the coupons are shown in Fig. 1.



(a)

(b)



(c)

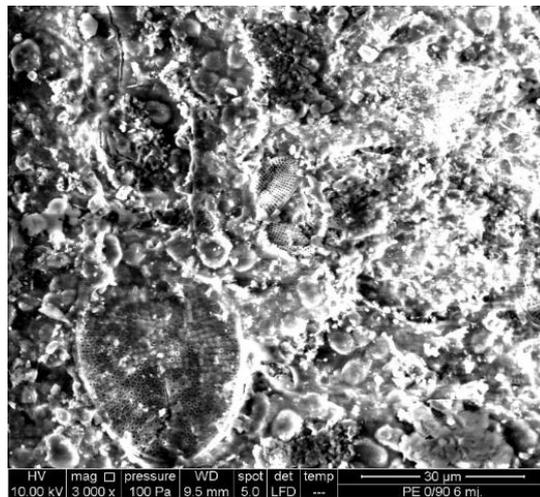

(d)

Figure 1. Attached bio-layer: (a) coupons in submerging fixture; (b) coupons after 2 years of submersion; (c) detail of marine organisms attached; (d) scanning electron image of embedded organisms after 6 months of exposure

The research was conducted keeping in mind the inspection and maintenance procedures of marine structures. Eventual damage points that can occur during the exploitation on the hull or any other point of such structures constructed using composites would represent an entry point for seawater. Marine vessels and structures are generally protected by a final gel coat layer or paint that protects them from water penetration. When damaged occurs on this protective layer during application, a more significant sea water intake rate in the structure material can be expected. Inspection and maintenance procedures should be planned in a manner to identify such problematic spots in time to minimize the negative effects of the environment to the structure itself.

The material used in this research was exposed to real marine environment in the form of standardized coupons [37] for a period of two years with testing and analysis performed after 6, 12 and 24 months. Most of the studies concerned with the environmental degradation of the material properties are based on laboratory experiments that either simulate real environment [38] or are conducted in accelerated manner [39]. Since marine structures need to operate in corrosive environment for long periods, there is a certain gap in research when it comes to experiments that are conducted in the natural environment for prolonged periods [40]. Laboratory results can be useful, but comprehensive overview can be gained only with the studies performed in the natural environment [41]. The parameters evaluated were mass gain due to seawater absorption, dimensional variations, tensile strength changes and material morphological variations. Special attention was given to the influence of marine organisms to the material strength.

2.2. Numerical analysis

2.2.1. Tensile test modelling

The experimental tensile test for dry coupons was modeled in ANSYS FEA software with the intent to verify the correlation of experimental testing and numerical modelling. The ACP (ANSYS Composite PrepPost) analysis system was used to model the three fiber layout configurations. The FE model was meshed using 4-node shell elements (ANSYS element designation SHELL181), in total comprising of 1034 nodes and 930 elements. The FEA model is shown in Fig. 2.

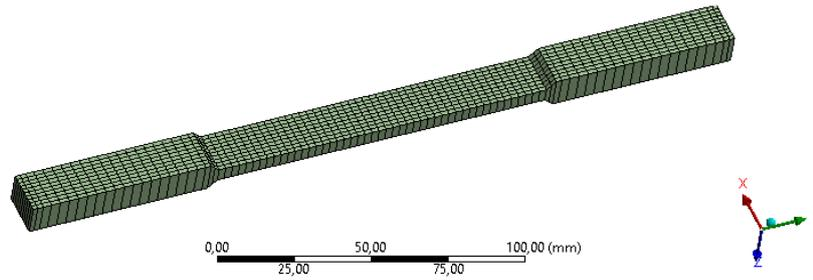

(a)

C: UD SHELL
 Static Structural
 Time: 50, s
 28.2.2022, 12:28

A Fixed Support
 B Displacement
 C Force: 25000 N

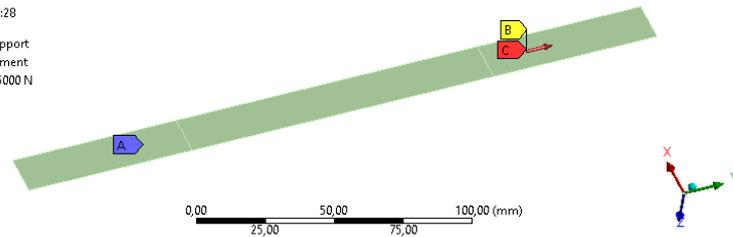

(b)

ACP Model
 Orientations
 Ply-Wise

Thickness,1
 10,999
 10,332
 9,6648
 8,9977
 8,3306
 7,6634
 6,9963
 6,3292
 5,6621
 4,995

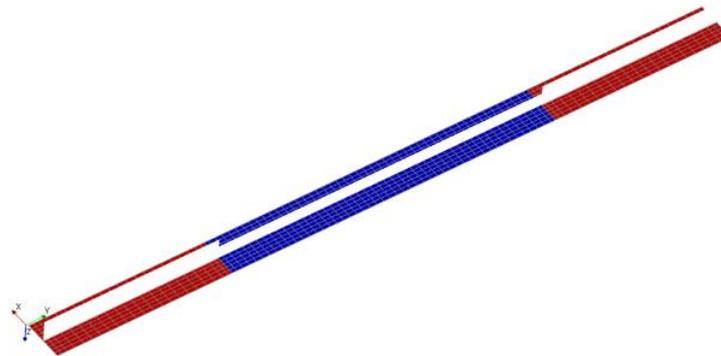

(c)

Figure 2. Tensile test FE model: (a) mesh; (b) boundary conditions; (c) ACP layup plot.

The material characteristics for the polyester resin used are density of 1200 kg/m^3 , elasticity modulus of 3240 MPa , effective stress limit of 42 MPa , Poisson's ratio of 0.316 , whilst the mechanical characteristics of the E-glass fibers were custom specified according to the manufacturer's specifications i.e. density of 2000 kg/m^3 , elasticity modulus of $52,7 \text{ GPa}$ in the fiber direction and 10 GPa in the transverse direction, effective tensile stress limit of 573 MPa along the fiber and 35 MPa in the transverse direction, shear stress limit of 74 MPa and Poisson's ratio of 0.3 . The ply type was set

as woven. Separate stack-up properties were defined for each fiber layout configurations in the ANSYS ACP tool for the 8-layered coupons and the tabs.

The critical loads were identified ply-wise by the first ply failure (FPF) criteria for each fiber layout configuration.

2.2.2. Regression analysis

The data collected during a 2-year period was consequently used for regression analysis in order to obtain a mathematical model for the strength degradation correlated to the exposure time in the marine environment. The obtained mathematical model was used to predict the loss of strength for a 10-year long period.

2.2.3. Structural durability assessment

Every marine structure (and/or component) has to pass a certification process prescribed by the regulations in order to prove its safety and functionality up to the end of the design life. A typical expected life period for such structures is from 25 to 40 years. The behavior of the structure in that period is closely related to durability. Much of research in this field is ongoing and only a small number of marine composite standards contain long term material properties concisely. Long-term properties of composite material exposed to the demanding marine environment must be determined in order to integrate the durability issues in the design standards. Current regulations tend to make very conservative assumptions regarding long-term structural behavior, mainly due to lack of detailed data. For example, the DNV standards [26,42] prescribes the procedure for the identification of critical failure mechanisms and the need for redesign if needed. The same standards emphasize the need for a reliable analysis and in the same time acknowledge a number of uncertainties in loads, materials and engineering models and consequently referring the designer to component and material testing for long term data. The marine structure or vessel qualification process requires identification of static strength, resistance to cyclic fatigue (full fatigue analysis using SN curves at different R-ratios required), stress rupture, damage tolerance and effects of the environment on the structure. It's important to mention that if the need for testing arises from the qualification process, static data and long-term data must be measured for the actual product which further complicates the design process.

The classification societies rules prescribe the procedure for obtaining S-N curves for composite materials. Various authors have reported results in modelling S-N curves for composites [29,34,35] and prediction of the fatigue life of composite structures [27,43,44]. A failure model for groups of similar glass/polyester composites, as the ones used in this research, can be defined in the form:

$$\log(N) = \alpha(\sigma_u/\sigma_{\max})^\beta, \quad (1)$$

where N is the number of fatigue life cycles, σ_u is the ultimate tensile strength (UTS) value, σ_{\max} is the maximal tensile stress occurring in the loaded structure, α and β are experimental data fitting coefficients [44]. Using material data for design purposes obtained previously or by other researchers for similar material type and configuration is acceptable according to classification societies rules.

The loads on marine structures and vessels depend mainly on environmental conditions [45]. The most influential are wave, wind and water current loads. Ocean waves are predominantly irregular and random in shape, height, length and speed of propagation. However, for structural design properties this load can be simplified by deterministic or stochastic methods. In order to determine the quasi-static response of marine structures and vessels design procedures prescribed by classification societies allow the definition of wave loadings by wave length and corresponding wave period, wave height and crest height [46].

3. Results

The results of the experimental investigation of polyester/glass coupons exposed to marine environment are presented in the form of diagrams, images and tables in previously published works by the authors of this article. Experimental testing results shown here pertain to the tensile strength determination and surface morphology changes observations as a continuation of previous work. Regression analysis was performed on the accumulated data and the results are shown here. A prediction model of fatigue life behavior of the material is proposed.

3.1. Regression analysis results

Regression results are shown in Fig.3.

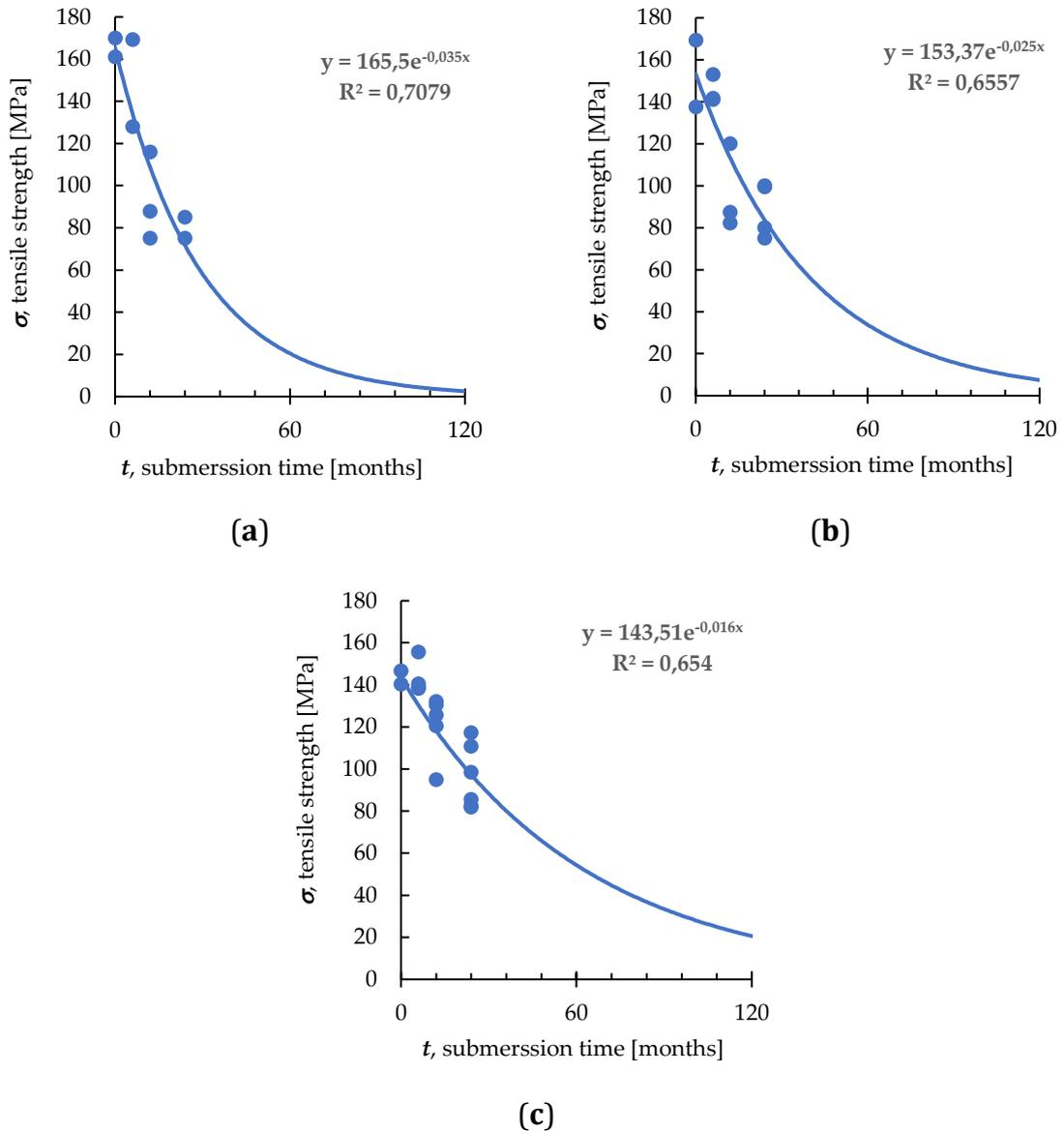

Figure 3. Mathematical strength degradation prediction model: **(a)** UD0°; **(b)** (0/90)s; **(c)** (0/45/90)s fiber layout configuration.

The dots represent the experimental data obtained during a 2-year period, whilst the line represents a future forecast of the degradation.

The model of regression that showed the best correlation to experimental data was an exponential equation in the form of:

$$\sigma_{it} = Ae^{Bt}, \quad (2)$$

where σ is the tensile strength value, t is the time of exposure to the marine environment and A and B are experimental data fitting coefficients. The coefficient A represents the average ultimate tensile stress of the non-submerged specimens tested. The regression parameters for the three considered fiber layout configurations are given in Table 1.

Table 1. Regression model data.

Fiber layout configuration	Coefficient A	Coefficient B	R ² value
UD0°	165,50	-0,0349	0,7079
(0/90)s	153,37	-0,0252	0,6557
(0/45/90)s	143,51	-0,0162	0,6540

By combining Eq (1) and Eq (2) a modified S-N curve equation can be obtained in the form:

$$\log(N) = \alpha[(Ae^{Bt})/\sigma_{\max}]^{\beta}, \quad (3)$$

3.2. Prediction of fatigue life behavior

The predicted changes in the S-N curves caused by the change in the ultimate strength value of the unidirectional samples due to the degradation of properties is shown in Fig. 4, 5 and 6.

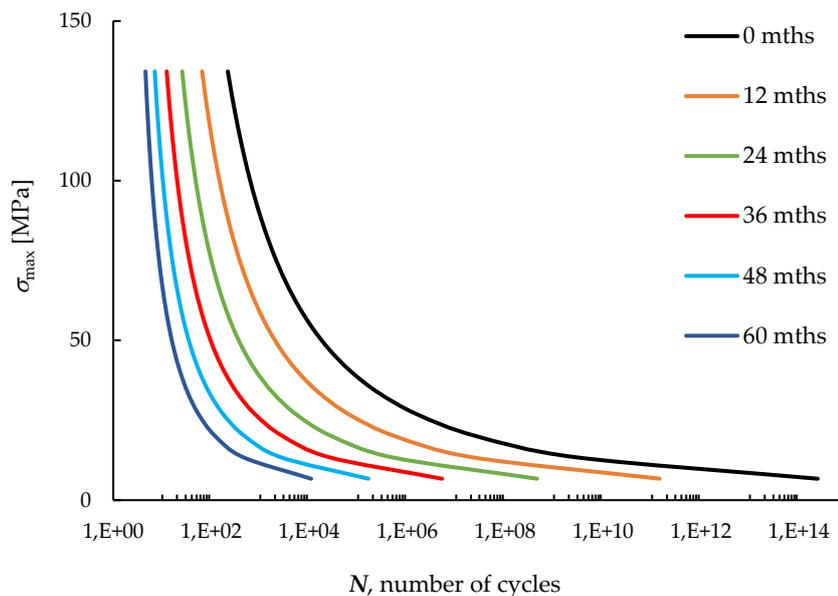

Figure 4. S-N curve change, UD0°polyester/glass composite

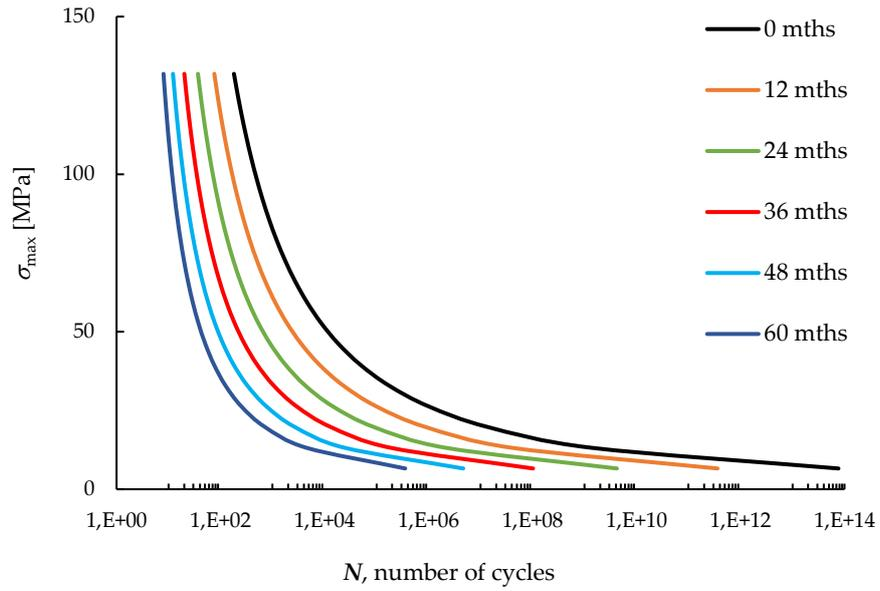

Figure 5. S-N curve change, UD0°polyester/glass composite

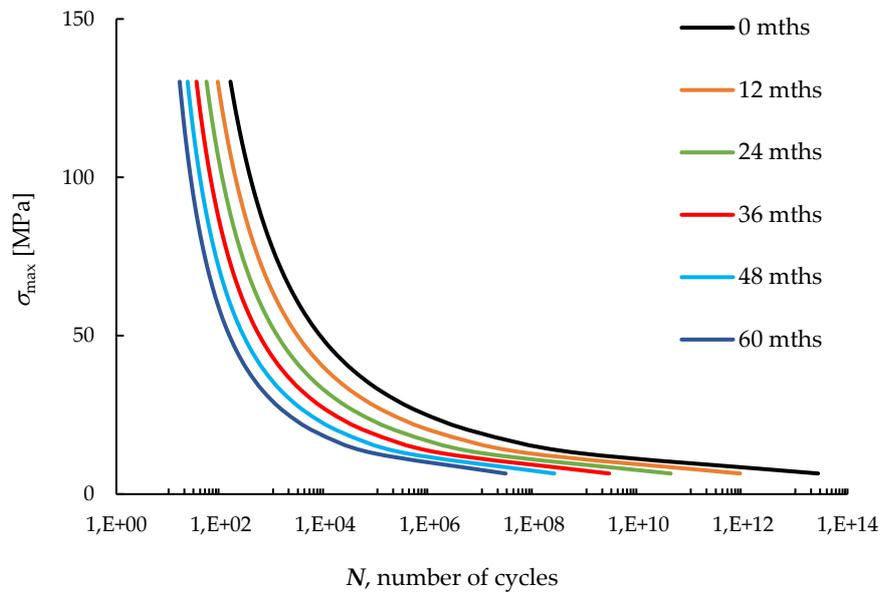

Figure 6. S-N curve change, UD0°polyester/glass composite

The predicted decrease of expected fatigue life caused by the comprehensive effects of the marine environment is shown in Fig. 7.

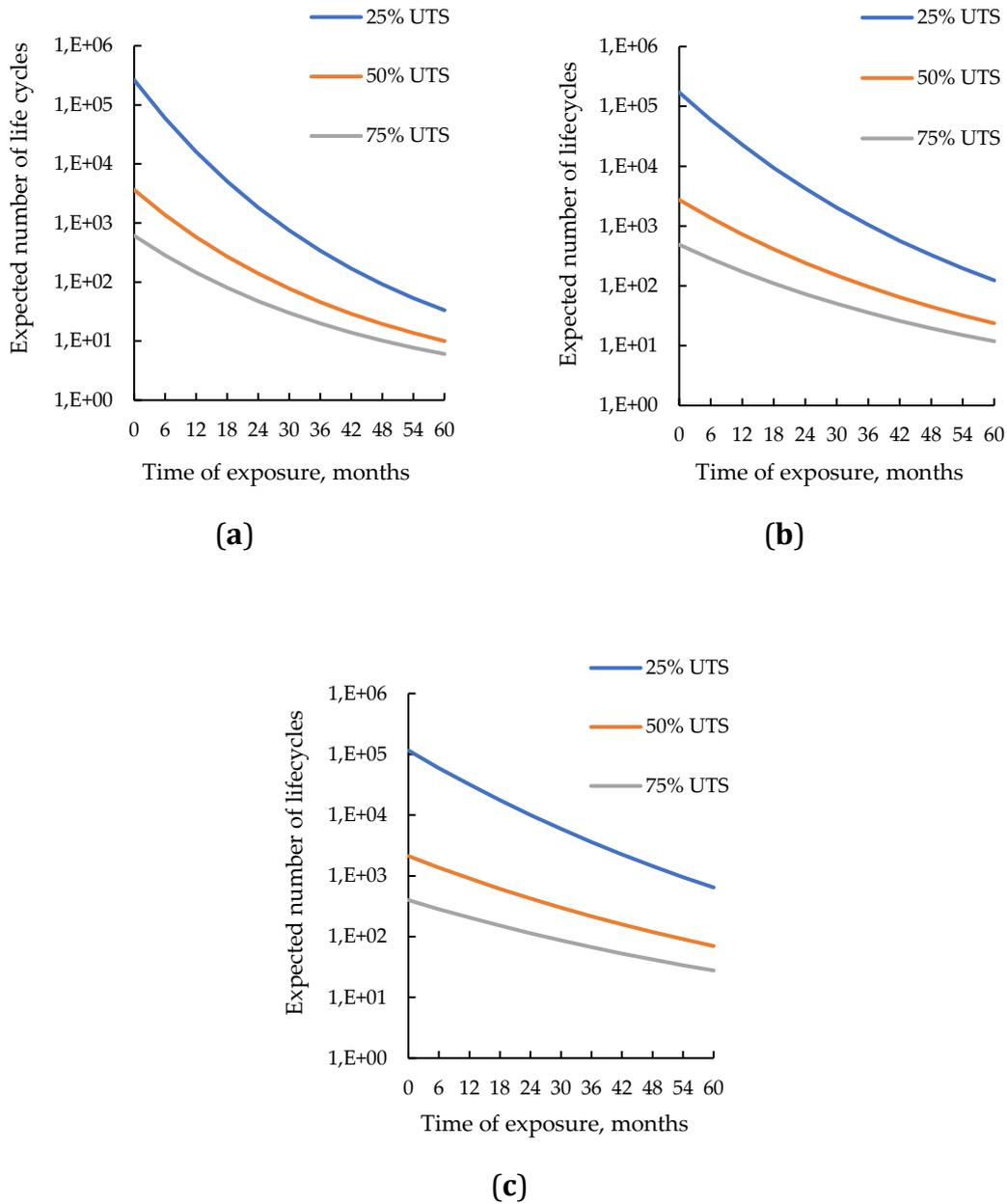

Figure 7. Normalized (α and β set to a single value) decrease of expected numbers of fatigue life cycles, polyester/glass composite: **(a)** UD0°; **(b)** (0/90)s; **(c)** (0/45/90)s fiber layout configuration.

4. Discussion

The results of the previous research phase conducted by the same authors have shown that the real sea environment has considerable effects on composite materials in the form of reduced mechanical strength after prolonged exposure [21]. Fatigue life decrease intensity has been predicted for all fiber layout configurations in respect to

the initial value calculated for dry coupons. The percentage of the strength reduction varies for different fiber layout configurations.

According to the model proposed in this work, after 5 years of exposure to the marine environment the expected fatigue life decrease (\log_{10} value) for the UD0° coupons at is -3.9, -2.6 and -2.0 for 25%, 50% and 75% UTS respectively. The other fiber layout configurations have exhibited similar behavior, namely the (0/90)s coupons values are -3.1, -2.1 and -1.6, while for the (0/45/90)s coupons these values are -2.3, -1.5 and -1.2.

This loss off ultimate strength implies that corrections in predicting the fatigue life have to be made, considering the time period the material has been submerged in the sea. The value of σ_u from Eq. (1) practically becomes time dependent. In order to incorporate the variation of ultimate strength a regression analysis of the tensile test experimental data was performed and a modified S-N curve was obtained.

The actual values of the number of life cycles shown in the results section are not to be considered for design purposes as the curves here shown are normalized to a single value of coefficients α and β . These coefficients should be determined experimentally for the actual type of composite material that would be used for a specific structure. The analysis was performed stepwise, meaning that firstly a fatigue life was estimated for reference (dry) coupons not exposed to the sea, and then re-estimated for the UTS values after each year.

There is no doubt that additional experimental data both for the 2-year long period of exposure (sea temperature at the location of experiment varies between 10–14 °C annually, salinity changes between 37.8–38.3 PPT, while the pH value is between 8.22–8.29) and longer would refine and raise the accuracy of this prediction model. New research has already been planned to broaden the database for composite material behavior in the marine environment, for strength and fatigue structural design aspects. Exposing coupons in various marine environment with different parameters (temperature, salinity, wave and wind characteristics) would broaden the applicability of this approach as well as increase the models' validity and accuracy.

Furthermore, as the UTS value is continually changing in time, a numerical method should be developed to obtain a continuous degradation S-N curve. This is the aim for further research.

Future work will strive to incorporate the continuous UTS change in the fatigue life decrease model described here and broaden the experimental database in order to develop a more comprehensive predictive numerical model that could successfully replace the time and resource consuming experiments related to composite material fatigue behavior characterization. Results of the study could prove helpful to determine the composite material type and fiber layout configuration during the engineering design phase of marine vessels and structures. With the acceptance of the importance of the marine environment influence on the mechanical behavior of composites and the application of the predictive model for fatigue life estimation process the rules and recommendations of classification societies in this industry sector could be amended to better the design of such structures.

5. Conclusions

The influence and real time exposure to actual sea environment on fatigue characteristics of glass/polyester composite material has been investigated showing the need for incorporating the time-decaying ultimate tensile stress in the S-N curves obtaining procedures.

As the previous research phases have shown the changes of composite materials mechanical characteristics induced by the actions of both water and marine organisms of the real sea environment are manifested as reduction of the ultimate mechanical strength. For example, the submerged polyester/E-glass UD⁰, (0/90)_s, and (0/45/90)_s coupons have lost 11%, 5%, and 1% after 6 months of submersion, 50%, 37%, and 13% after 12 months in the sea and 55%, 48% and 24% after 24 months in the water. The results also indicate fiber layout configurations dependency of the UTS changes, with the (0/45/90)_s layout showing the greatest resilience to the marine environment. The research up to this phase has made evident that further study is needed due to the 2 main reasons. Firstly, the polyester coupons were made by hand-layup process, which can significantly affect mechanical characteristics of the composite. Secondly, the exact mechanism of marine organisms attachment on the surface and marine microorganisms imbedding in the resin, as well as the consequences of these phenomenon on the mechanical properties of composites

exposed to the sea is not known to a satisfactory level. These issues will surely be topics of future research.

Research findings summary:

1. An initial mathematical model of the phenomenon has been developed based on experimental data gathered.
2. The loss of ultimate strength requires corrections of the fatigue life predicting procedures for composites exposed to the sea.
3. The reduction of ultimate tensile strength for composite materials exposed to the marine environment has a direct influence on the material's fatigue behavior.
4. The research results confirmed once again the importance of biofouling in the environmental degradation of mechanical properties of composite materials in the marine environment.
5. Future work needed to develop a numerical method to encompass the continuous UTS decay and increase the accuracy of the prediction model.

Supplementary Materials: N/A

Author Contributions: Conceptualization, G.Vi.; methodology, G.Vi.; formal analysis, G.Vi.; investigation, G.Vi.; writing—original draft preparation, G.Vi.; writing—review and editing, G.Vu.; visualization, G.Vi.; supervision, G.Vu.; project administration, G.Vu.; funding acquisition, G.Vu. All authors have read and agreed to the published version of the manuscript.

Funding: This research was funded by University of Rijeka, under the project numbers uniri-technic-18-200 "Failure analysis of materials in marine environment" and uniri-technic-18-42 "Investigation, analysis and modeling the behavior of structural elements stressed at room and high temperatures".

Conflicts of Interest: The authors declare no conflict of interest. The funders had no role in the design of the study; in the collection, analyses, or interpretation of data; in the writing of the manuscript, or in the decision to publish the results.

References

1. Kim, D.-U.; Seo, H.-S.; Jang, H.-Y. Study on Mechanical Bearing Strength and Failure Modes of Composite Materials for Marine Structures. *J. Mar. Sci. Eng.* **2021**, *9*, 726, doi:10.3390/jmse9070726.
2. Wang, C.; Ge, S.; Jaworski, J.W.; Liu, L.; Jia, Z. Effects of Different Design Parameters on the Vortex Induced Vibration of FRP Composite Risers Using Grey Relational Analysis. *J. Mar. Sci. Eng.* **2019**, *7*, 231, doi:10.3390/jmse7070231.

3. Vukelic, G.; Vizentin, G. Composite Wrap Repair of a Failed Pressure Vessel — Experimental and Numerical Analysis. *Thin-Walled Struct.* 2021, 169, 108488, doi:10.1016/j.tws.2021.108488.
4. Vukelic, G.; Vizentin, G.; Bakhtiari, R. Failure Analysis of a Steel Pressure Vessel with a Composite Wrap Repair Proposal. *Int. J. Press. Vessel. Pip.* 2021, 193, 104476, doi:10.1016/j.ijpvp.2021.104476.
5. Lukács, J.; Koncsik, Z.; Chován, P. Integrity Reconstruction of Damaged Transporting Pipelines Applying Fiber Reinforced Polymer Composite Wraps. *Procedia Struct. Integr.* 2021, 31, 51–57, doi:10.1016/j.prostr.2021.03.009.
6. Cejuela, E.; Negro, V.; del Campo, J.M. Evaluation and Optimization of the Life Cycle in Maritime Works. *Sustain.* 2020, 12, doi:10.3390/su12114524.
7. Diez de Ulzurrun, I.; López, F.; Herreros, M.A.; Suárez, J.C. Tests of Deck-to-Hull Adhesive Joints in GFRP Boats. *Eng. Fail. Anal.* 2007, 14, 310–320, doi:10.1016/j.engfailanal.2006.02.012.
8. Lee, S.-G.; Oh, D.; Woo, J.H. The Effect of High Glass Fiber Content and Reinforcement Combination on Pulse-Echo Ultrasonic Measurement of Composite Ship Structures. *J. Mar. Sci. Eng.* 2021, 9, 379, doi:10.3390/jmse9040379.
9. Watanabe Junior, M.M.; Reis, J.M.L.; da Costa Mattos, H.S. Polymer-Based Composite Repair System for Severely Corroded Circumferential Welds in Steel Pipes. *Eng. Fail. Anal.* 2017, 81, 135–144, doi:10.1016/j.engfailanal.2017.08.001.
10. Yang, Z.; Cao, Y.; Liu, J. A Buckling Analysis and Optimization Method for a Variable Stiffness Cylindrical Pressure Shell of AUV. *J. Mar. Sci. Eng.* 2021, 9, 637, doi:10.3390/jmse9060637.
11. Durability of Composites in a Marine Environment; Davies, P., Rajapakse, Y.D.S., Eds.; *Solid Mechanics and Its Applications*; Springer Netherlands: Dordrecht, 2014; Vol. 208; ISBN 978-94-007-7416-2.
12. Durability of Composites in a Marine Environment 2; Davies, P., Rajapakse, Y.D.S., Eds.; *Solid Mechanics and Its Applications*; Springer International Publishing: Cham, 2018; Vol. 245; ISBN 978-3-319-65144-6.
13. Martin, R. *Ageing of Composites*; Woodhead Publishing Limited: Cambridge England, 2008; ISBN 978-1-84569-352-7.
14. Takacs, L.; Kovacs, L.; Olajos, T. Numerical Tool with Mean-Stress Correction for Fatigue Life Estimation of Composite Plates. *Eng. Fail. Anal.* 2020, doi:10.1016/j.engfailanal.2020.104456.
15. Gljušćić, M.; Franulović, M.; Lanc, D.; Božić, Ž. Digital Image Correlation of Additively Manufactured CFRTP Composite Systems in Static Tensile Testing. *Procedia Struct. Integr.* 2021, 31, 116–121, doi:10.1016/j.prostr.2021.03.019.
16. Brčić, M.; Krščanski, S.; Brnić, J. Rotating Bending Fatigue Analysis of Printed Specimens from Assorted Polymer Materials. *Polymers (Basel)*. 2021, 13, 1020, doi:10.3390/polym13071020.
17. Venkatesan, K.; Ramanathan, K.; Vijayanandh, R.; Selvaraj, S.; Raj Kumar, G.; Senthil Kumar, M. Comparative Structural Analysis of Advanced Multi-Layer Composite

- Materials. Mater. Today Proc. 2020, 27, 2673–2687, doi:10.1016/j.matpr.2019.11.247.
18. Kastratović, G.; Grbović, A.; Sedmak, A.; Božić, Ž.; Sedmak, S. Composite Material Selection for Aircraft Structures Based on Experimental and Numerical Evaluation of Mechanical Properties. *Procedia Struct. Integr.* 2021, 31, 127–133, doi:10.1016/j.prostr.2021.03.021.
 19. Sousa, J.; Marques, J.; Garcia, M.; Infante, V.; Amaral, P. Mechanical Characterization of Sandwich Composites with Embedded Sensors. *Eng. Fail. Anal.* 2020, 117, 104765, doi:10.1016/j.engfailanal.2020.104765.
 20. Tomasz, M.; Szymon, D.; Bartosz, B.; Joanna, W.; Paweł, Z.; Grzegorz, L. Flexural and Compressive Residual Strength of Composite Bars Subjected to Harsh Environments. *Eng. Fail. Anal.* 2022, 133, 105958, doi:10.1016/j.engfailanal.2021.105958.
 21. Vizentin, G.; Glujić, D.; Špada, V. Effect of Time-Real Marine Environment Exposure on the Mechanical Behavior of FRP Composites. *Sustainability* 2021, 13, 9934, doi:10.3390/su13179934.
 22. Vizentin, G.; Vukelic, G. Degradation and Damage of Composite Materials in Marine Environment. *Medziagotyra* 2019, doi:10.5755/j01.ms.26.3.22950.
 23. Tamboura, S.; Abdessalem, A.; Fitoussi, J.; Ben Daly, H.; Tcharkhtchi, A. On the Mechanical Properties and Damage Mechanisms of Short Fibers Reinforced Composite Submitted to Hydrothermal Aging: Application to Sheet Molding Compound Composite. *Eng. Fail. Anal.* 2022, 131, 105806, doi:10.1016/j.engfailanal.2021.105806.
 24. Padmaraj, N.H.; Vijaya, K.M.; Shreepannaga; Amritha, U.; Dayananda, P. Slurry Erosion Behaviour of Carbon/Epoxy Quasi-Isotropic Laminates Based on Taguchi's Optimization Method. *Eng. Fail. Anal.* 2021, 123, 105274, doi:10.1016/j.engfailanal.2021.105274.
 25. Rubino, F.; Nisticò, A.; Tucci, F.; Carlone, P. Marine Application of Fiber Reinforced Composites: A Review. *J. Mar. Sci. Eng.* 2020, 8, 26, doi:10.3390/jmse8010026.
 26. DNV-OS-C501 Composite Components. *Det Nor. Verit.* 2010, 119–134.
 27. Djeghader, D.; Redjel, B. Fatigue of Glass-Polyester Composite Immersed in Water. *J. Eng. Sci. Technol.* 2017, 12, 1204–1215.
 28. Smith, L.V.; Weitsman, Y.J. *The Immersed Fatigue Response of Polymer Composites*; 1996;
 29. Vázquez, J.; Silvera, A.; Arias, F.; Soria, E. Fatigue Properties of a Glass-Fibre-Reinforced Polyester Material Used in Wind Turbine Blades. *J. Strain Anal. Eng. Des.* 1998, 33, 183–193, doi:10.1243/0309324981512904.
 30. Kennedy, C.R.; Leen, S.B.; Ó Brádaigh, C.M. Immersed Fatigue Performance of Glass Fibre-Reinforced Composites for Tidal Turbine Blade Applications. *J. Bio-Tribo-Corrosion* 2016, 2, 12, doi:10.1007/s40735-016-0038-z.
 31. Gagani, A.I.; Mialon, E.P.V.; Echtermeyer, A.T. Immersed Interlaminar Fatigue of Glass Fiber Epoxy Composites Using the I-Beam Method. *Int. J. Fatigue* 2019, 119, 302–310, doi:10.1016/j.ijfatigue.2018.10.011.

32. Zhang, W.; Zhou, Z.; Zhang, B.; Zhao, S. A Phenomenological Fatigue Life Prediction Model of Glass Fiber Reinforced Polymer Composites. *Mater. Des.* 2015, 66, 77–81, doi:10.1016/j.matdes.2014.10.036.
33. Mouritz, A.P. A Simple Fatigue Life Model for Three-Dimensional Fiber-Polymer Composites. *J. Compos. Mater.* 2006, 40, 455–469, doi:10.1177/0021998305055199.
34. Yasar, A.; Kacar, İ.; Keskin, A. Tensile and Fatigue Behavior of Glass Fiber-Reinforced (MAT-8)/Polyester Automotive Composite. *Arab. J. Sci. Eng.* 2014, 39, 3191–3197, doi:10.1007/s13369-013-0897-2.
35. Burhan, I.; Kim, H. S-N Curve Models for Composite Materials Characterisation: An Evaluative Review. *J. Compos. Sci.* 2018, 2, 38, doi:10.3390/jcs2030038.
36. Vizentin, G.; Vukelic, G. Failure Analysis of FRP Composites Exposed to Real Marine Environment. *Procedia Struct. Integr.* 2022, 37, 233–240, doi:10.1016/j.prostr.2022.01.079.
37. INTERNATIONAL STANDARD ISO 527 Plastics - Determination of Tensile Properties; 2020;
38. Choi, Y.Y.; Lee, S.H.; Park, J.-C.; Choi, D.J.; Yoon, Y.S. The Impact of Corrosion on Marine Vapour Recovery Systems by VOC Generated from Ships. *Int. J. Nav. Archit. Ocean Eng.* 2019, 11, 52–58, doi:10.1016/j.ijnaoe.2018.01.002.
39. Kovač, N.; Ivošević, Š.; Vastag, G.; Vukelić, G.; Rudolf, R. Statistical Approach to the Analysis of the Corrosive Behaviour of NiTi Alloys under the Influence of Different Seawater Environments. *Appl. Sci.* 2021, 11, 8825, doi:10.3390/app11198825.
40. Vukelic, G.; Vizentin, G.; Ivosevic, S. Tensile Strength Behaviour of Steel Plates with Corrosion-Induced Geometrical Deteriorations. *Ships Offshore Struct.* 2021, 1–9, doi:10.1080/17445302.2021.2006969.
41. Vukelic, G.; Vizentin, G.; Brnic, J.; Brcic, M.; Sedmak, F. Long-Term Marine Environment Exposure Effect on Butt-Welded Shipbuilding Steel. *J. Mar. Sci. Eng.* 2021, 9, 491, doi:10.3390/jmse9050491.
42. DNV GL AS DNVGL-ST-C501 Composite Components; 2017;
43. Kim, H.S.; Huang, S. S-N Curve Characterisation for Composite Materials and Prediction of Remaining Fatigue Life Using Damage Function. *J. Compos. Sci.* 2021, 5, 76, doi:10.3390/jcs5030076.
44. Silvera, A.; Vazquez, J.; Vinssac, V. Strain Analysis of a Glass-Fibre-Reinforced Polyester under Dynamic Loads. *Spanish J. Agric. Res.* 2011, 9, 49, doi:10.5424/sjar/20110901-444-10.
45. DNV Environmental Conditions and Environmental Loads; <http://www.dnv.com>, 2014; p. 182;.
46. DNV Wave Loads; www.dnv.com, 2021; p. 81;.

D. Composite wrap repair of a failed pressure vessel— Experimental and numerical analysis

Goran Vukelic, Goran Vizentin

Abstract: This experimental and numerical study deals with the failure of two steel pressure vessels that failed during hydrostatic test at a pressure lower than test pressure. Failure was noticed because of pressure drop and fluid leakage during the test and, later, by observing through-wall cracks that formed on the vessels. Experimentally, visual and ultrasonic non-destructive testing was performed to check the vessel for possible cracks and to measure wall thickness. Microscopy was employed to inspect the existing cracks and determine their dimensions. Results revealed pitting corrosion at the bottom part of the vessel to be the cause of the cracks. Numerical analysis was performed to assess the possibility of retaining the functionality of the vessel by using composite patch repair procedure. Results proved that repaired vessel can retain the pressure bearing capacity and numerically obtained results were confirmed by experimental investigation on the similar vessels. As a conclusion, some recommendations are given to avoid future failures of such pressure vessels.

Keywords: Pressure vessel; Pressure vessel failure; Pressure test; Leak-before-break; Composite patch repair

1. Introduction

Pressure vessels made of steel are prone to corrosion and one of the most damaging corrosion forms is pitting [1]. Small holes or pits are caused when corrosive medium attacks confined areas on the surface of the metal. Pits are distributed irregularly and pose a threat to the structural integrity. Pits tend to reduce the load carrying capacity of the vessel, intensify local stresses and act as one of the most important causes of vessel failures [2]. Complete insight into the formation, distribution and size of the pits is needed to estimate the structural integrity loss.

Corrosion and pitting have been discussed in numerous previous scientific studies. Corrosive environment significantly reduces fatigue strength of the structural steel when compared with results of tests performed in laboratory conditions [3]. Experimentally, a laboratory study of long-term under-deposit corrosion was performed to reveal that deposit-covered pipelines experienced severe pitting corrosion and greater pit depths [4]. A comprehensive experimental and numerical analysis was performed to develop simplified pitting model capable of assessing collapse pressure of corroded pipe [5,6]. Structural integrity of pipelines was proved

to deteriorate significantly in the presence of corrosion defects, as proven by FITNET FFS procedure [7]. Stochastic analysis of corroded pipelines considering corrosion growth in three dimensions revealed that this type of corrosion model significantly impacts reliability and remaining operational life of a pipeline [8]. FE study showed the importance of adequate modelling of corrosion defects in order to properly estimate burst pressure capacity of pipelines [9].

Most of the previous research dealing with retaining the functionality of damaged thin-walled structures follows the idea of applying composite patch repair technique [10,11]. Finite element analysis revealed that the composite repairment can be used to restore the pressure bearing capacity of the steel pipelines, even when the localized damaged reach 70% of material loss [12]. Same group of authors provided a complete review of the use of polymer composites for repairs of different types of pipeline, along with discussing possible future directions of research in this section [13]. A theoretical study combined with FE analysis was used to determine stress intensity factors for double-edged cracked steel plates strengthened with fiber reinforced polymer composites [14]. A parametric study was done to determine the influence of composite patch thickness on fatigue crack growth life extension of low-strength structural steel pipes [15]. Analytical and numerical analysis of a pressure vessel with multiple cracks and composite reinforcement showed that critical internal pressure does not differ much for a single and multiple cracked vessel and that laminates with higher elasticity modulus have more effect on the critical internal pressure [16].

Pressure equipment failures can endanger safety of the people and produce negative economic impact, so studying the origins of the failures can help in avoiding such scenarios. This experimental and numerical study deals with the failure of two steel pressure vessels, part of an air compressor unit, that failed during hydrostatic test. Causes of failures are determined and a method to repair damaged vessels is proposed. The proposed repair technique relies on applying composite patches over the damaged area of the vessel in order to retain pressure bearing capacity of the vessel. Composite repair technique is a practical choice for engineers since the cost of the composite material is generally acceptable and it can be rather easily applied. Care must, however, be taken to properly choose the material (i.e. type, thickness,

dimensions, ply orientation) and to recognize the type of failure that can be repaired successfully. This is also the aim of this paper.

2. Experimental failure analysis

Two steel pressure vessels failed during hydrostatic test that was performed with water as a test fluid. No previous repairs, inspections or tests performed were noted. Pressure vessels were used as a part of an air compressor unit in a shipyard, kept in horizontal position, manufactured in 1984. Both vessels are identical in terms of design and have a declared volume of 60 l and mass of 21.3 kg. However, actual weighted masses were 21.6 kg and 21.8 kg, respectively. Working pressure of the vessels is 8 bar and test pressure is set at 13 bar. Fig. 1 gives general dimensions of the vessels, with thickness of the shell wall $t = 3$ mm.

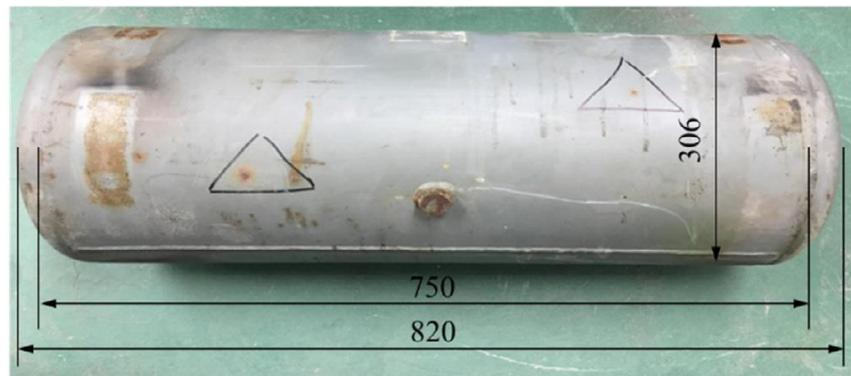

Fig. 1. General dimensions of the vessel (in mm).

Failure occurred during hydrostatic pressure test, a test that can be classified as one of the full-scale tests that are considered the most informative regarding the state of welded pressurized structures [17]. However, pressure tests can sometimes provoke the formation of cracks and leakage of the contained fluid [18], therefore caution is needed in performing the test meaning that the pressure needs to be raised gradually and the state of the vessel monitored continuously. The test was performed using a hand pump with the aim of reaching and holding designed test pressure of 13 bar. Analogue pressure gauges and digital pressure transducer were connected to the vessel to monitor the change in pressure, Fig. 2. When reaching pressure about 20% lower than the test value, fluid leakage was observed from two locations on each of the vessels, Fig. 2. Also, pressure drop was noticed on the pressure gauges and computer

display connected to digital pressure transducer. Hydrostatic pressure test was terminated at that point and experimental failure analysis followed.



Fig. 2. Hydrostatic test setup with details of fluid leakage.

Outer and inner surfaces were first examined visually using magnifying glass and borescope. Uniformly spread surface corrosion at the contact area with the saddle holdings of the compressor unit were noticed on the outer surface, but in extent that did not substantially deteriorate the material. Also, sporadic localized corrosion points were noted, Fig. 2. Special attention was given to inspection of weld line, but no excessive corrosion was noted. Inner surface was found to be uniformly heavily corroded and multiple points with excessive corrosion were noted that are adequate to definition of pitting corrosion points. This type of material damage seriously threatens the pressure bearing capacity of the vessels [19].

Further non-destructive tests were performed, as a powerful tool in assessing the condition of the pressure equipment [20]. Ultrasonic testing (UT) was performed to determine possible variations in shell thickness of the vessel. A minimum of five

measurements was taken at every location indicated in Fig. 3 and average results are given in Table 1.

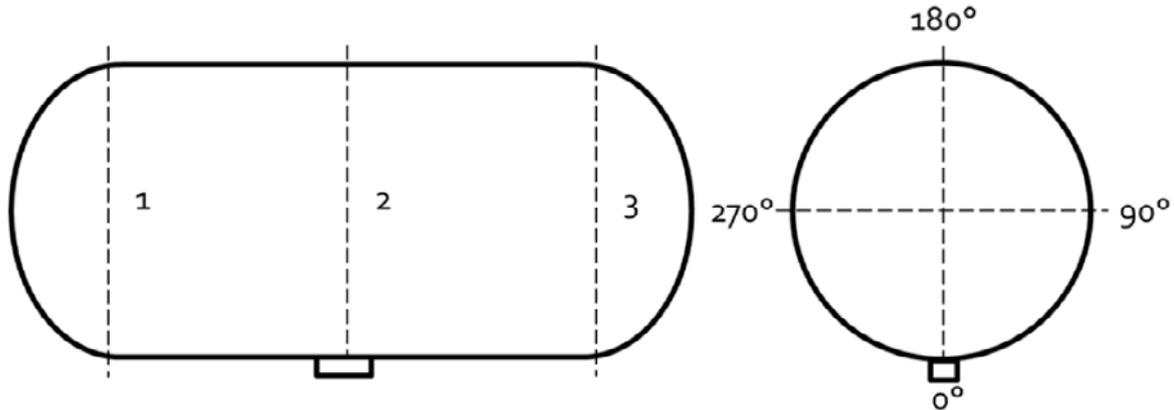

Fig. 3. Orientation and zones of performed ultrasonic shell thickness measurement.

Table 1. Measured shell thickness (in mm).

Zone	Orientation			
	0°	90°	180°	270°
1	2.5	2.7	2.6	2.7
2	1.9	2.1	2.7	1.9
3	2.7	2.6	2.6	2.8

Further research was employed on specimens that were cut out of one vessel. Chemical composition of steel was determined using glow discharge spectrometer, Table 2, and it was found that the composition of tested material is adequate to steel EN 10028-2 grade P235GH (other designations: 1.0345, ASTM A285 Grade 60).

Table 2 Chemical composition of the material (wt%).

C	Si	Mn	P	S	Cr	Ni	Nb
0.094	0.0376	0.401	0.0194	0.0122	0.0249	0.0191	0.0039
Cu	Al	Sn	W	Co	Pb	As	Mo
0.086	0.0631	0.0069	0.0079	0.0044	0.0003	0.0013	0.0043

Measured mean hardness value was found to be 590 HV (Vickers hardness number) and maximum tensile strength derived from the hardness value [21] is $\sigma_{TS} = 3.2HV = 410.88$ MPa. Hardness test was performed on the inside and the outside surface of the vessel at the zone 2 and 90° and 270° orientation on the vessel, Fig. 3. According to the standard, for steel plate thickness less than 6 mm maximum tensile strength is $\sigma_{TS} = 360-480$ MPa and yield strength $\sigma_{YS} = 235$ MPa. Since the yield stress of the material

is quite low, possibility of significant plastic deformation arises. However, designed working pressure does not introduce excessive stress to the structure that could provoke this type of deformation and the experimental hydrostatic test was terminated (due to safety reasons) before the significant plastic deformation of the structure was noticed.

Cut-out specimens containing cracks were used to perform microscopic examination, Fig. 4, using optical and scanning electron microscope (SEM), Figs. 5 and 6.



Fig. 4. Cut-out specimen containing crack used to perform microscopic examination.

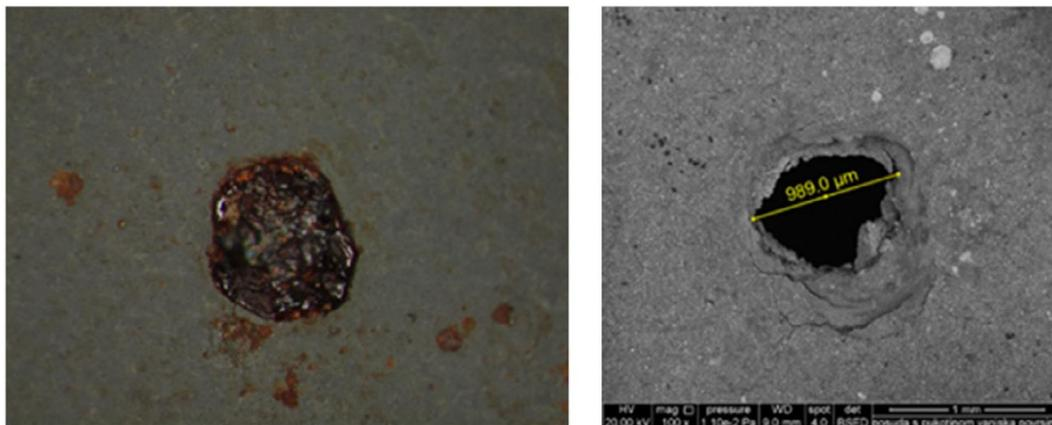

a)

b)

Fig. 5. Image of a pitting point on the outer surface taken by: (a) optical microscope at 20x magnification; (b) SEM at 100x magnification.

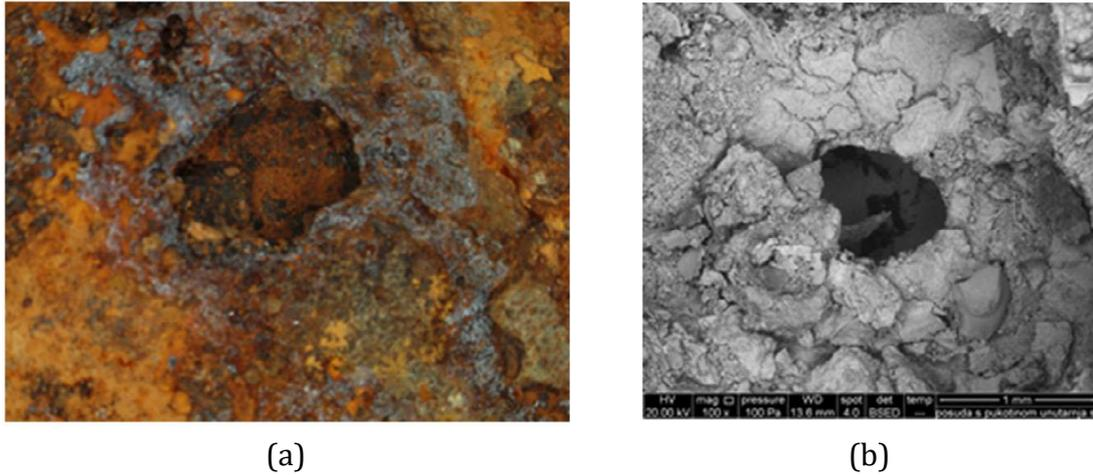

Fig. 6. Image of a pitting point on the inner surface taken by: (a) optical microscope at 20x magnification; (b) SEM at 100x magnification.

3. Numerical analysis

A numerical analysis was performed in order to validate the applicability of fiber reinforced polymer (FRP) patches as a repair technique for pressure equipment damaged by corrosion. This technique utilizes fibers bonded both together and to the equipment by the means of cured resins, often in-situ. The patch type considered here is the hoop-wrapped one.

The analysis is performed using commercial FE analysis software package ANSYS. The input data is based the on experimentally collected geometrical and mechanical characteristics of the vessel, as described in Section 2.

First, a static structural analysis of the undamaged vessel is performed with the goal to assess the stress distribution and to confirm the validity of the vessel design. Making use of symmetry of the vessel and to reduce computational time, only half of the vessel is modelled and meshed with quadratic order elements (TET10), Fig. 7. Pressure load is imposed on the inner surface of the vessel. 3D FE analysis was performed instead of also acceptable 2D in order to gain more comprehensive results without significantly extending the computational time.

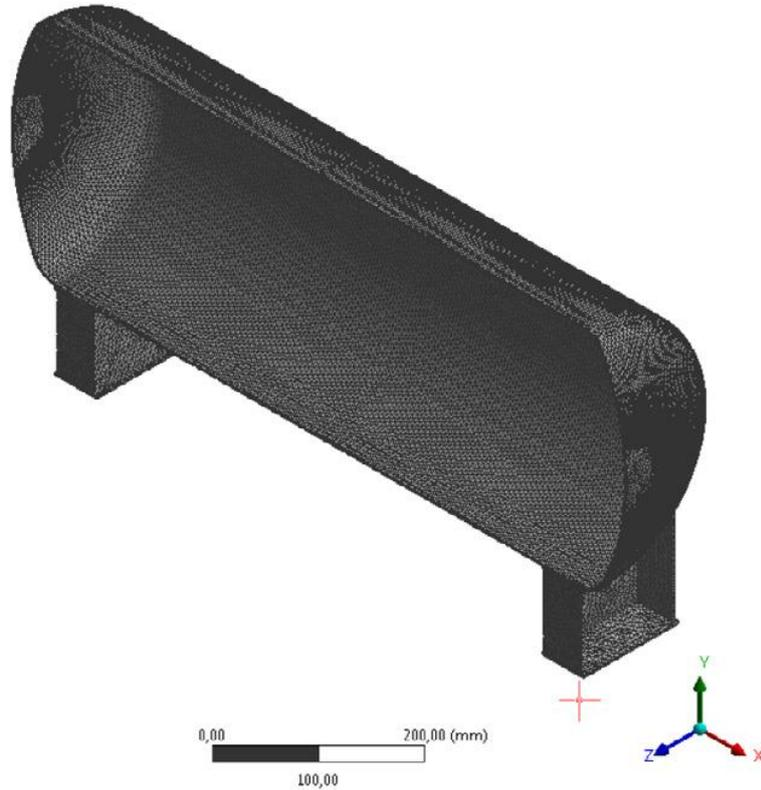

Fig. 7. Meshed FE model of the considered pressure vessel.

An additional stress analysis is performed on a model of vessel with introduced pitting corrosion damage. Pitting holes are introduced in 20 locations on the vessel, Fig. 8a, five of them at every angle orientation presented at Fig. 3. Pitting is modelled as a conical hole (2.9 mm deep and leaving a 0.1 mm shell thickness as measured during SEM microscopic examination), Fig. 8b, according to obtained SEM images.

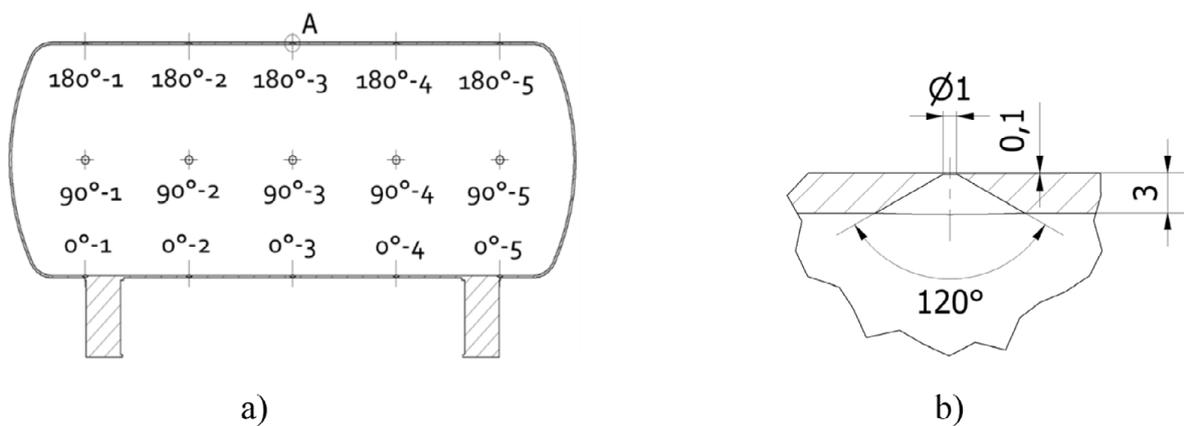

Fig. 8. Pitting introduced in a FE model of pressure vessel: (a) pitting holes locations (angle and number); (b) detail A - pitting hole geometry (all dimension in mm).

As the corrosion propagates, through-wall cracks occur followed by fluid leakage, i.e. repair is necessary. The repair method proposed here consists of an FRP composite hoop-wrapped patch, 100 mm in width, applied in the leak zone.

The patch is modelled using surface geometry which is “layered up” with uni-directional (UD) epoxy-glass woven pre-pregs in a $(0^\circ/-45^\circ/45^\circ/90^\circ)$ layup configuration using the ANSYS ACP system. The layer adjacent to the vessel is modelled as epoxy resin, whilst the composite patch itself consists of 4 layers of the UD pre-preg 0.4 mm in thickness. The patch is meshed with TRI3 and QUAD4 elements, Fig. 9.

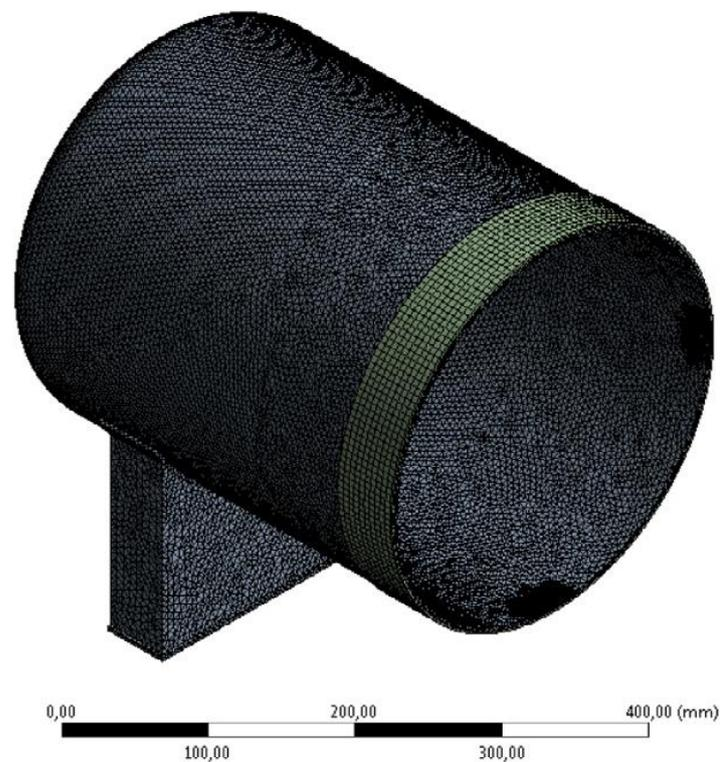

Fig. 9. Meshed FE model of the vessel with applied patch assembly (section view).

This type of composite material was chosen since the epoxy-glass combination deteriorates significantly less in the presence of water than other types of composites [22]. As for the layer configuration, the chosen one has already been proven as suitable for repairing thin-walled structures [23,24].

4. Results and discussion

Testing of material chemical composition revealed that the pressure vessels were made of steel under designation P235GH (1.0345, ASTM A285). It is a low to intermediate tensile strength carbon steel used in the manufacturing of pressure vessels by fusion welding. It comes in a plate of maximum thickness of 50 mm. Vessels made of this type of steel are usually storage tanks and low-pressure vessels, i.e. it is used in non-critical pressure vessel applications. Various types of pressure equipment, e.g. pressure vessels, steam tubes, heat exchangers, boilers, etc., are made of this pressure vessel steel and application can be found in vast array of different industries.

Visual and optical microscopic investigation of the outer surface revealed localized corrosion points, Figs. 4 and 5a, but better understanding of the damage magnitude came with SEM investigation that revealed these corrosion points propagated through the entire thickness of the shell, Fig. 5b. SEM was also used to measure diameter of pits, Fig. 5b. Visual and optical microscopic investigation of the inner surface revealed uniformly and heavily corroded surface with pitting corrosion points on the bottom section of the vessels, Figs. 4 and 6a. SEM investigation of the area around pits, Fig. 6b, revealed large quantity of corrosion products. This corrosion most obviously served as a trigger for pit formation, growth and propagation towards outer surface of shell. When comparing Figs. 5 and 6, it can clearly be noticed how the corrosion propagated from the inside surface of the wall since this part has gradual increase of mechanical damage when approaching

the center of the hole from the outside perimeter, Fig. 6. Outer surface, on the other hand, shows only signs final failure (through-hole), Fig. 6a, with some signs of delamination around the hole, Fig. 6b.

As said in the introduction, pits are caused when corrosive medium attacks confined areas on the surface of the metal. It is indicative that pitting formed mainly on lower section of the vessels, close to the drainage opening. UT measurement, Table 1, revealed that shell thickness is greatly reduced in that area, up to 36% of the initial thickness. The most excessive reduction of the thickness occurred in zone 2, at 0° orientation measurement point, Fig. 3, where the drainage hole is located. This is the area where the liquid fluid in air compressor vessels concentrates and can, if not drained regularly, cause damage to the vessel. It seems reasonable to conclude that

this excessive corrosion in that area is a result of inadequate maintenance of the vessel without regular draining and cleaning. This, coupled with lack of regular NDT inspection and hydrostatic pressure testing, led to build-up of corrosion products on the inner surface that caused the change in the weight of the vessels and formation of corrosion pits.

Cracks, pits and other forms of surface damage of pressure vessels tend to reduce the thickness of their shell, forming only a narrow ligament of material that must withstand the service load. As the service load in pressure vessel alternates, these defects may grow in size to form through-thickness cracks. As the cracks open, leaking of internally stored fluid can be expected followed with a loss of pressure inside the vessel. This situation leaves time for preventing the vessel from final failure. Scenario is known as leak-before-break (LBB) and is one of the most important criteria for safe design of pressure vessels and pipelines [25]. LBB is also the scenario that developed during hydrostatic testing of the considered vessels. This type of scenario also helps in retaining the safety of operating vessel as it functions as a structural stress relief. This is of special importance when the gaseous fluid is contained inside the vessel. LBB is a fail-safe design concept for application in pressure vessels when a quantitative maximum allowable flaw size is required to set acceptance/rejection limit to predict whether the specific cracked pipe will leak or break [26].

In order to verify the FE model, numerically obtained values of circumferential (σ_c) and longitudinal (σ_l) stress are compared with ones obtained analytically, Table 3, with $\sigma_c = pr/t$ and $\sigma_l = \sigma_c/2$ [27], for working pressure $p = 8$ bar, radius $r = 150$ mm and thickness $t = 3$ mm.

Table 3 Comparison of numerically and analytically obtained values of circumferential (σ_c) and longitudinal (σ_l) stress.

Analytically		Numerically	
σ_c (MPa)	σ_l (MPa)	σ_c (MPa)	σ_l (MPa)
40	20	41,348	20,343

The stress levels in the damaged vessel near the pitting holes are significantly higher than in the rest of the vessel body, Figs. 10 and 11. The stress in the longitudinal

direction of the damage area reaches the yield stress level of the material, which explains the formation of the through-thickness holes.

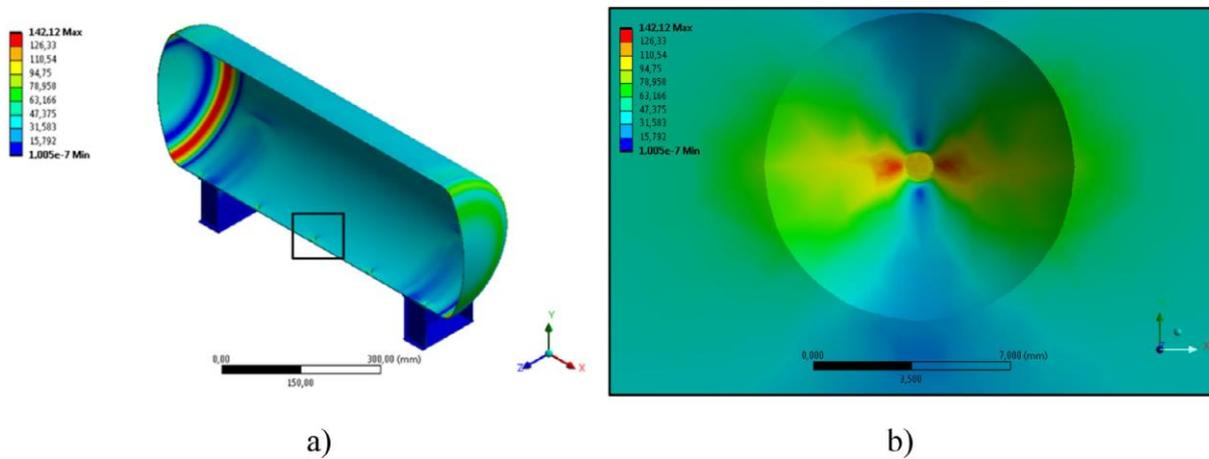

Fig. 10. Equivalent (von Mises) stress distribution at working pressure for damaged vessel: (a) cross section; (b) hole detail.

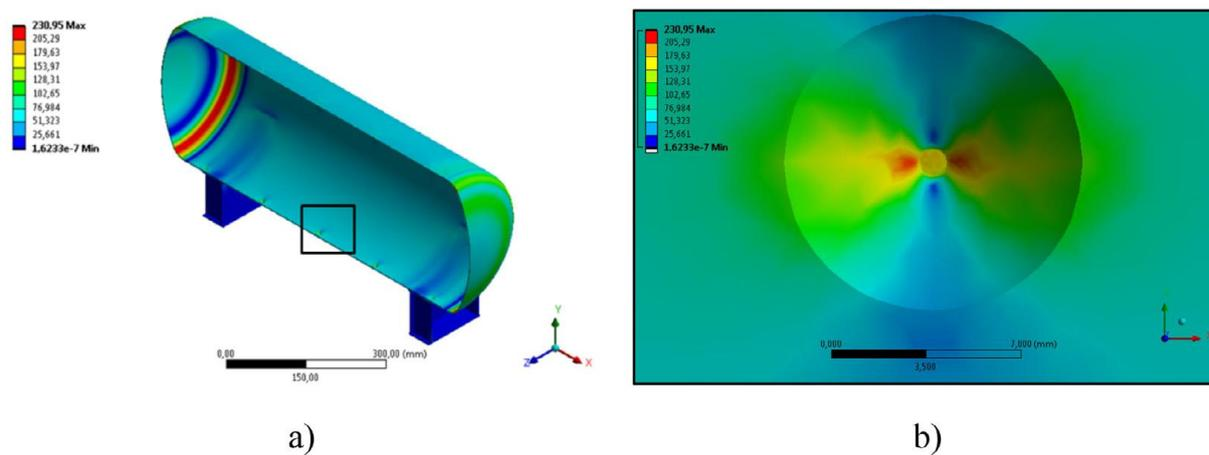

Fig. 11. Equivalent (von Mises) stress distribution at test pressure for damaged vessel: (a) cross section; (b) hole detail.

Once the holes have been formed the vessel loses its function to retain fluid, so repairs become necessary. The stress analysis shows stress concentration points, caused by geometry changes due to corrosion damage, localized to the damage area exceeding the permitted value for von Mises stress of 282 MPa [28]. Particular attention has been given to the bottom holes as the most extensive pitting has been noticed there, Figs. 12 and 13.

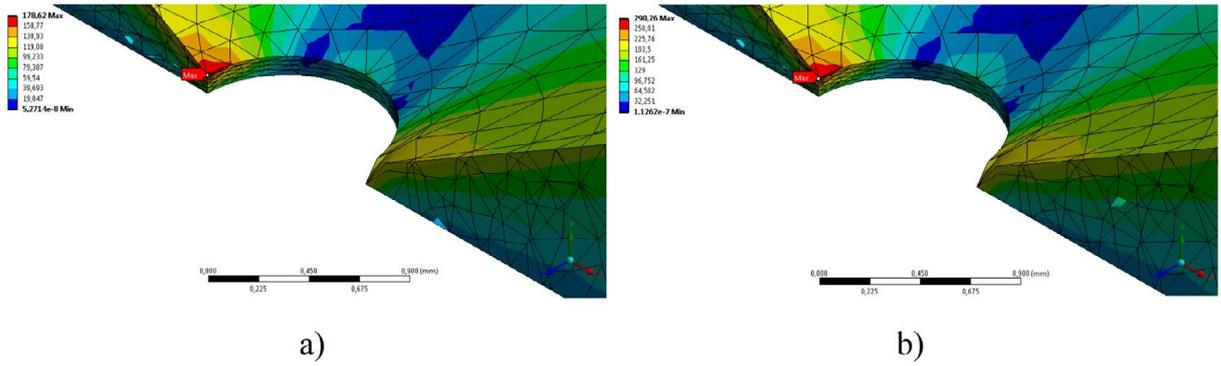

Fig. 12. Equivalent (von Mises) stress distribution at the center bottom hole (position 0° -3, Fig. 7a) at: (a) working pressure; (b) test pressure.

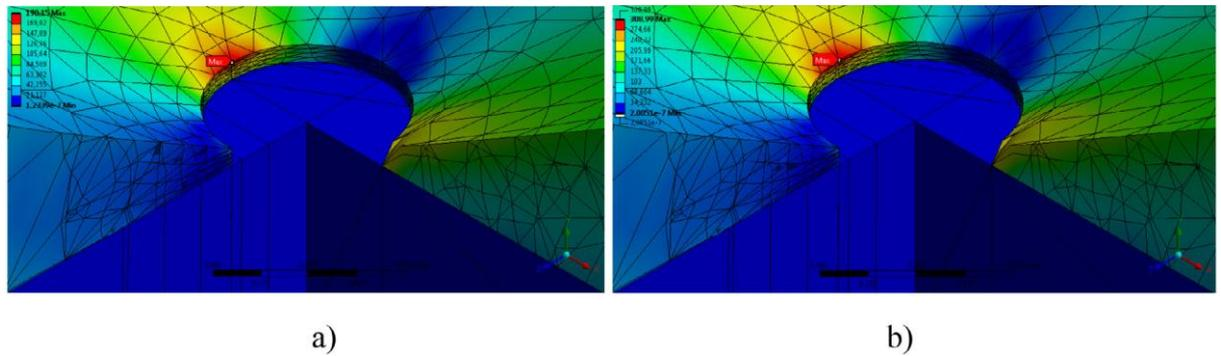

Fig. 13. Equivalent (von Mises) stress distribution at the center bottom hole (position 0° -3, Fig. 7a) with patch applied at: (a) working pressure; (b) test pressure.

The stress distribution in the hoop-wrapped patch is shown in Fig. 14, and in the vessel in Fig. 15.

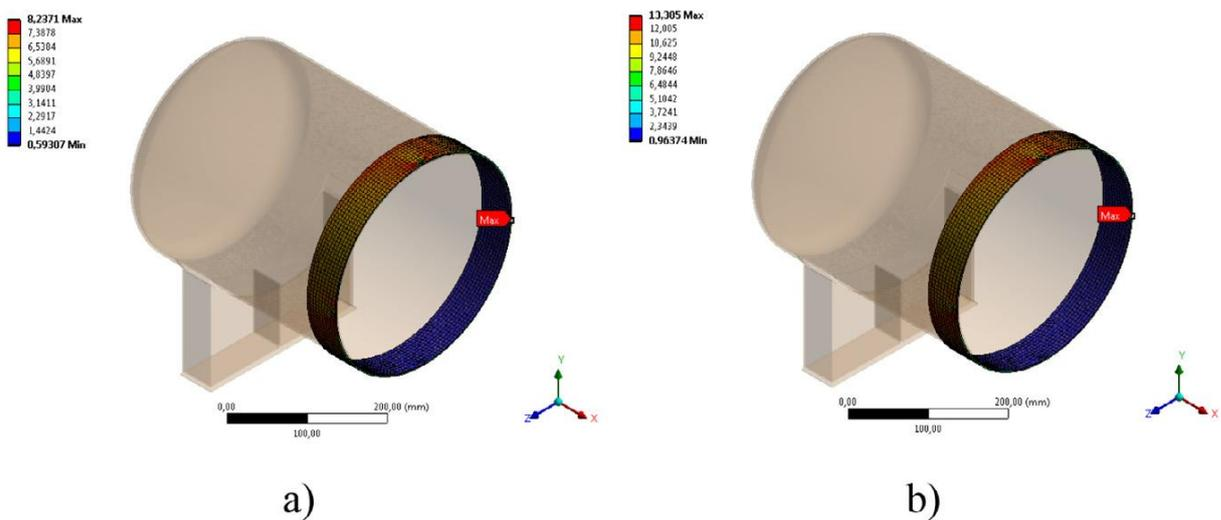

Fig. 14. Equivalent (von Mises) stress distribution at the patch covering 1 mm diameter hole at: (a) working pressure; (b) test pressure.

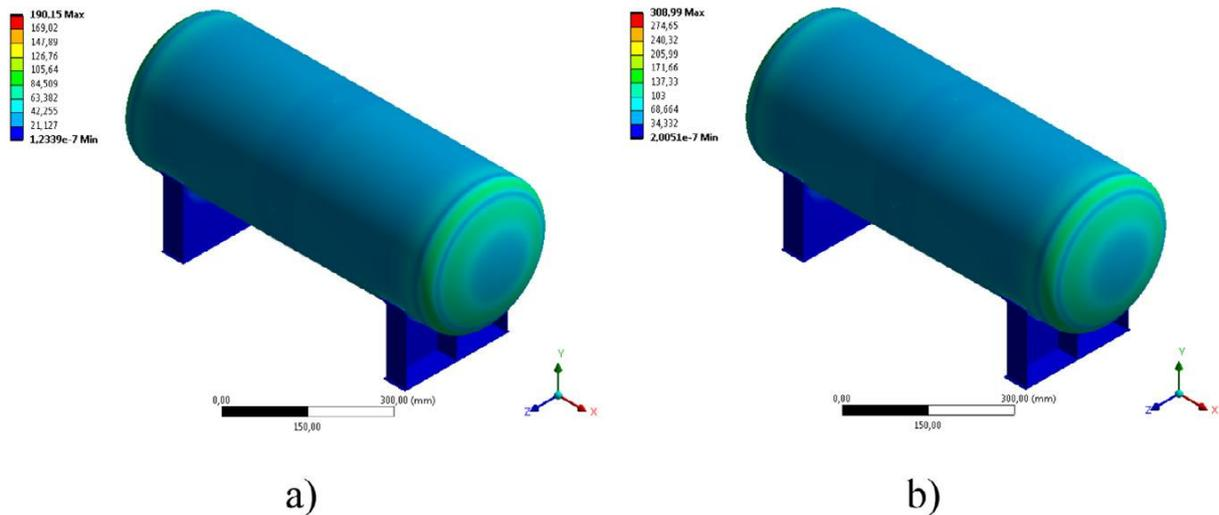

Fig. 15. Equivalent (von Mises) stress distribution over the vessel with 1 mm diameter hole at: (a) working pressure; (b) test pressure.

The maximum stress in the vessel, which is above the maximum allowed value, can be reduced by enlarging the diameter of the through thickness hole. This is achieved by drilling a 12 mm diameter hole. This procedure is, in fact, necessary to remove corrosion products around the initial pitting hole and help in future corrosion retardation. Also, 12 mm diameter is necessary in order to confirm the applicability and suitability of hoop-wrapped patching repair [29].

Repeating the same analysis for the new hole geometry shows the maximum stress for both loading cases occurring on the torispherical head of the vessel, Fig. 16, which is outside the patch area. In both cases (142 MPa and 231 MPa, respectively), the stress value is below the maximum permitted equivalent stress of the material.

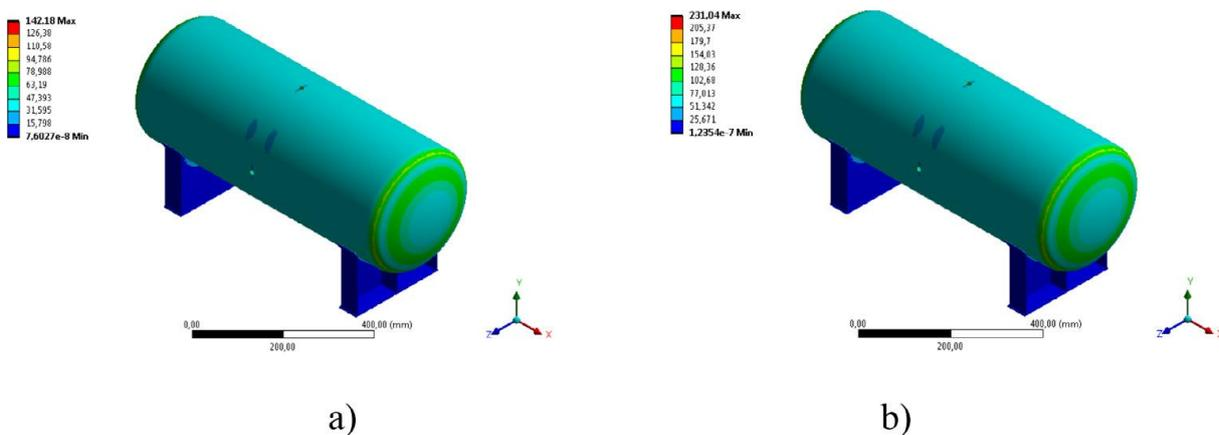

Fig. 16. Equivalent (von Mises) stress distribution over the vessel with 12 mm diameter hole at: (a) working pressure; (b) test pressure.

However, the increase of the hole diameter causes an increase of the patch stress which is still below the maximum allowable values, Fig. 17. For the test pressure load the maximum fiber direction stress in the bottom layer of the patch is 1.91 MPa and in the top layer 33.17 MPa.

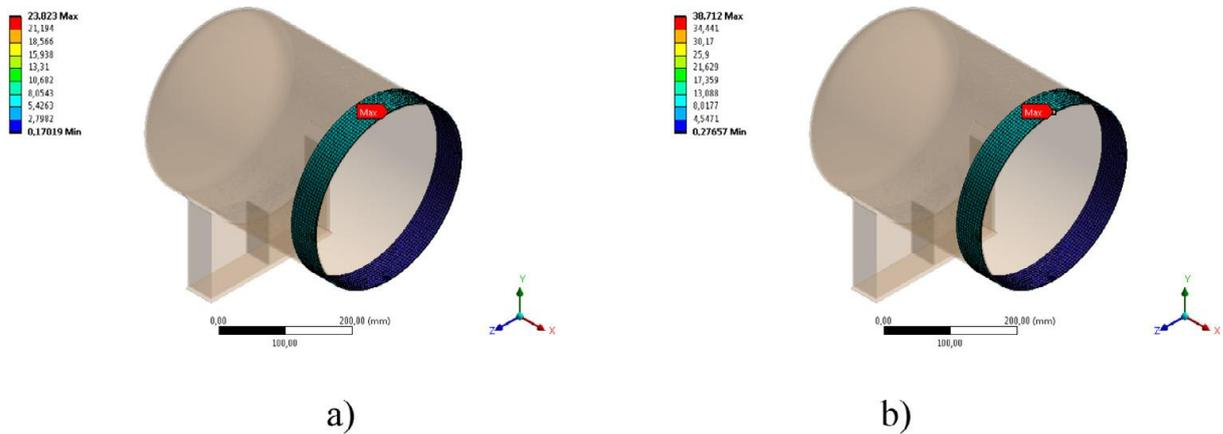

Fig. 17. Equivalent (von Mises) stress distribution at the patch covering 12 mm diameter hole at: (a) working pressure; (b) test pressure.

The composite failure criteria applied here is a combination of maximum stress and Puck failure criteria. The value of the failure index of 1 indicates that the material in a layer will fail. An element-wise failure analysis is conducted for the test pressure load, showing the failure index varying from the minimal value of 0.077 to the maximum of 0.32, Fig. 18. This indicates that the patch is adequate to withstand the said pressure.

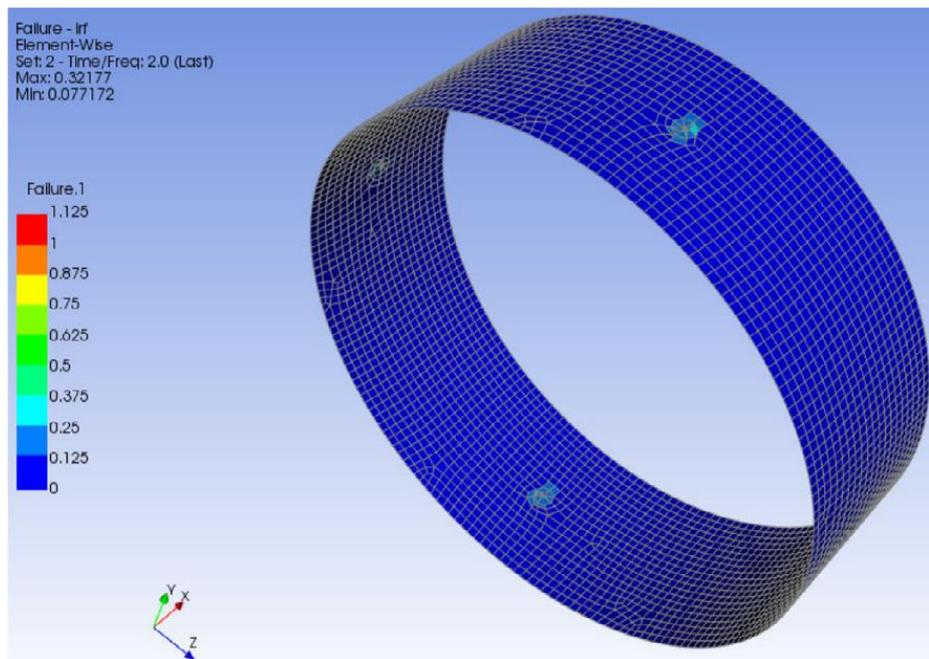

Fig. 18. Equivalent (von Mises) stress distribution in a patch over a 12 mm diameter hole at test pressure load.

In order to experimentally test the suitability of the proposed repair technique, hydrostatic pressure tests were performed on two similar steel pressure vessels. Pressure vessel concerned were of 123 mm outer diameter, 720 mm overall length, 4.5 mm wall thickness, 12 mm through-hole at the middle of the body and an epoxy-glass composite patch of 400 mm in length was applied to cover the hole, Fig. 19.

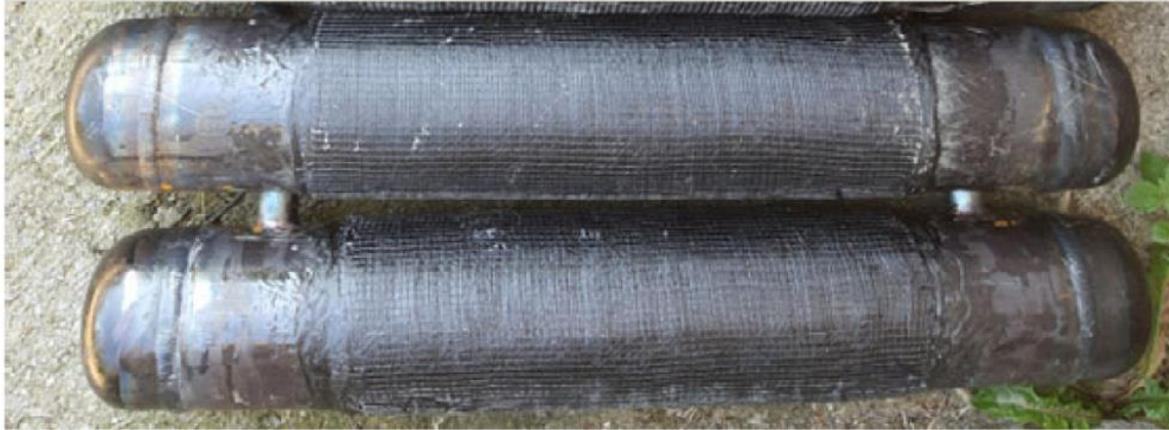

Fig. 19. Pressure vessels with composite patch repair examined using hydrostatic test.

Hydrostatic test followed the same procedure as already described, but until the burst of the composite patch to inspect the maximum possible pressure that the patch can withstand. Results of the hydrostatic tests for two vessels are given in Fig. 20, where the gradual rise of the pressure over time can be monitored.

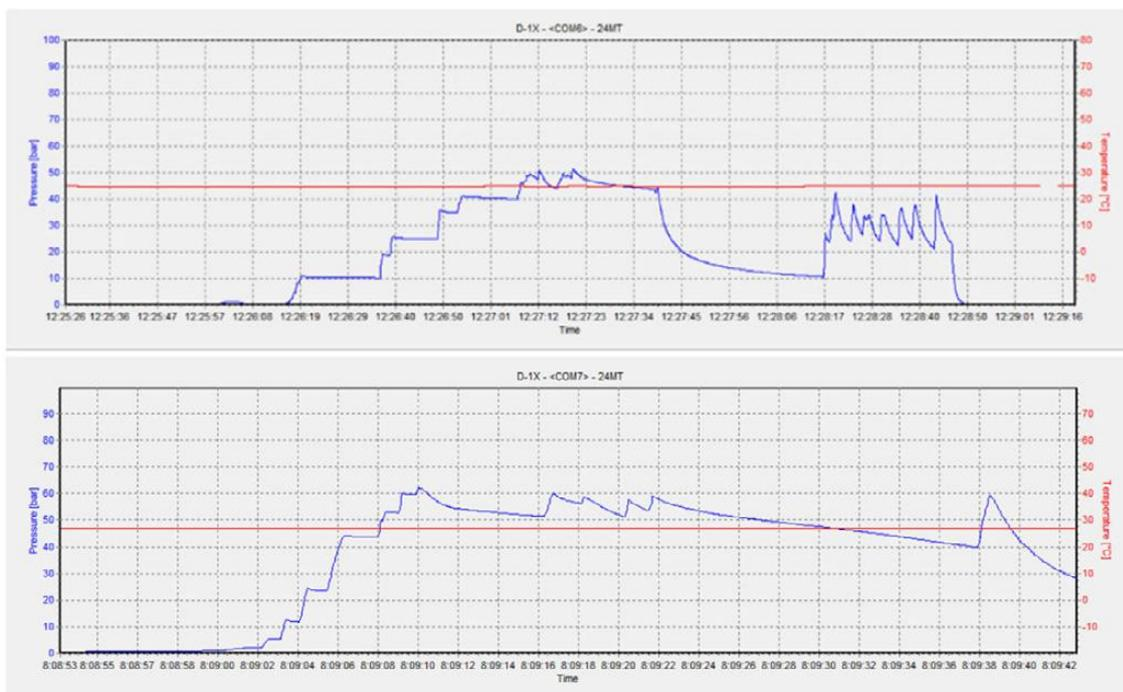

Fig. 20. Pressure rise over time during hydrostatic tests performed until burst for two vessels.

Bursting occurred at the value of just over 50 bar, significantly higher than the maximum allowable pressure. It is interesting to note that the bursting occurred at the edge of the patch, not in the location of the hole, Fig. 21.



Fig. 21. Detail of the test fluid bursting on the edge of the composite patch.

5. Conclusion

In this study, experimental and numerical analysis was employed to determine the possible causes of pressure vessels failure and to propose a suitable repair technique in order the functionality of the vessels. Experimental investigation comprised of technical data acquisition, visual and ultrasonic non-destructive testing (NDT), characterization of material and microscopic analysis. Numerical stress analysis was performed using FE method to assess the possibility of employing composite patch repair technique. The results obtained by the FE analysis have been confirmed by performing experimental hydrostatic tests on similar pressure vessels repaired with composite patches.

Experimental results suggest that the root cause of the failure is inadequate maintenance of the vessels, i.e. irregular draining, deficient cleaning, lack of scheduled

NDT inspections and hydrostatic pressure testing. This opened a path for a corrosion process most severe at the bottom part of the shell where excessive corrosion pitting has been detected. Leak-before-break scenario developed with vessel failing to pass hydrostatic pressure test well below the test pressure value.

While the initial design of the vessel was satisfactory, it is clear that inadequate maintenance caused the failure so recommendations of this study are aimed at that direction and direction of repairing the already damaged vessels. Possible recommendations to avoid such failure in the future would include adequate maintenance of remaining un-damaged vessels: cleaning, draining, NDT inspection and regular hydrostatic pressure testing with appropriate choice of inspection technique.

For already damaged vessels, hoop-wrapping repair method with composite patches is proposed. If the results of the FE stress analysis of the damaged and repaired vessels are compared, it can clearly be noted that with composite patch repair can successfully withstand the working and test pressure, while the damaged cannot contain the fluid. Experimental analysis of repaired vessel also shows that this type of repairment is able to withstand designed pressure.

Possible directions for future research on this matter would include optimization of the composite patches in the terms of their dimensions, thickness and the orientation of the layers. Composites lose some of their load bearing capacity when exposed to aggressive environment [22] which should also be studied.

CRedit authorship contribution statement: Goran Vukelic: Conceptualization, Funding acquisition, Methodology, Writing – original draft, Validation, Supervision. Goran Vizentin: Investigation, Data curation, Formal analysis, Software, Writing – original draft, Visualization.

Declaration of competing interest: The authors declare that they have no known competing financial interests or personal relationships that could have appeared to influence the work reported in this paper.

Acknowledgement: This work has been supported by the University of Rijeka, Croatia within the project uniri-technic-18-200 “Failure analysis of materials in marine environment”.

References

- [1] G. Vukelic, G. Vizentin, J. Brnic, M. Brcic, F. Sedmak, Long-term marine environment exposure effect on butt-welded shipbuilding steel, *J. Mar. Sci. Eng.* 9 (2021) 491, <http://dx.doi.org/10.3390/jmse9050491>.
- [2] M. Cerit, Corrosion pit-induced stress concentration in spherical pressure vessel, *Thin-Walled Struct.* 136 (2019) 106–112, <http://dx.doi.org/10.1016/j.tws.2018.12.014>.
- [3] G. Qian, C. Zhou, Y. Hong, Experimental and theoretical investigation of environmental media on very-high-cycle fatigue behavior for a structural steel, *Acta Mater.* 59 (2011) 1321–1327, <http://dx.doi.org/10.1016/J.ACTAMAT.2010.10.064>.
- [4] X. Wang, R.E. Melchers, Long-term under-deposit pitting corrosion of carbon steel pipes, *Ocean Eng.* 133 (2017) 231–243, <http://dx.doi.org/10.1016/j.oceaneng.2017.02.010>.
- [5] H. Wang, Y. Yu, J. Yu, J. Duan, Y. Zhang, Z. Li, C. Wang, Effect of 3D random pitting defects on the collapse pressure of pipe — Part I: Experiment, *Thin-Walled Struct.* 129 (2018) 512–526, <http://dx.doi.org/10.1016/j.tws.2018.04.015>.
- [6] H. Wang, Y. Yu, J. Yu, C. Jin, Y. Zhao, Z. Fan, Y. Zhang, Effect of 3D random pitting defects on the collapse pressure of pipe — Part II: Numerical analysis, *Thin-Walled Struct.* 129 (2018) 527–541, <http://dx.doi.org/10.1016/j.tws.2018.04.014>.
- [7] G. Qian, M. Niffenegger, S. Li, Probabilistic analysis of pipelines with corrosion defects by using FITNET FFS procedure, *Corros. Sci.* 53 (2011) 855–861, <http://dx.doi.org/10.1016/J.CORSCI.2010.10.014>.
- [8] Y. Wang, M.R. Dann, P. Zhang, Reliability analysis of corroded pipelines considering 3D defect growth, *Thin-Walled Struct.* 157 (2020) 107028, <http://dx.doi.org/10.1016/j.tws.2020.107028>.
- [9] S. Zhang, W. Zhou, Assessment of effects of idealized defect shape and width on the burst capacity of corroded pipelines, *Thin-Walled Struct.* 154 (2020) 106806, <http://dx.doi.org/10.1016/j.tws.2020.106806>.
- [10] A. Mohabeddine, J.A.F.O Correia, P.A. Montenegro, J.M. Castro, Fatigue crack growth modelling for cracked small-scale structural details repaired with CFRP, *Thin-Walled Struct.* 161 (2021) 107525, <http://dx.doi.org/10.1016/J.TWS.2021.107525>.
- [11] N. Silvestre, B. Young, D. Camotim, Non-linear behaviour and load-carrying capacity of CFRP-strengthened lipped channel steel columns, *Eng. Struct.* 30 (2008) 2613–2630, <http://dx.doi.org/10.1016/J.ENGSTRUCT.2008.02.010>.
- [12] M. Shamsuddoha, A. Manalo, T. Aravinthan, M. Mainul Islam, L. Djukic, Failure analysis and design of grouted fibre-composite repair system for corroded steel

- pipes, *Eng. Fail. Anal.* 119 (2021) 104979, <http://dx.doi.org/10.1016/j.engfailanal.2020.104979>.
- [13] M. Shamsuddoha, M.M. Islam, T. Aravinthan, A. Manalo, K. Lau, Effectiveness of using fibre-reinforced polymer composites for underwater steel pipeline repairs, *Compos. Struct.* 100 (2013) 40–54, <http://dx.doi.org/10.1016/j.compstruct.2012.12.019>.
- [14] H.-T. Wang, G. Wu, Y.-Y. Pang, Theoretical and numerical study on stress intensity factors for FRP-strengthened steel plates with double-edged cracks, *Sens.* 18 (2018) 2356, <http://dx.doi.org/10.3390/s18072356>.
- [15] M. Ali Ghaffari, H. Hosseini-Toudeshky, Fatigue crack propagation analysis of repaired pipes with composite patch under cyclic pressure, *J. Press. Vessel Technol.* 135 (2013) <http://dx.doi.org/10.1115/1.4023568>.
- [16] E. Alizadeh, M. Dehestani, Analytical and numerical fracture analysis of pressure vessel containing wall crack and reinforcement with CFRP laminates, *Thin-Walled Struct.* 127 (2018) 210–220, <http://dx.doi.org/10.1016/j.tws.2018.02.009>.
- [17] A. Sedmak, S. Kirin, T. Golubovic, S. Mitrovic, P. Stanojevic, Risk based approach to integrity assessment of a large spherical pressure vessel, *Procedia Struct. Integr.* (2016) <http://dx.doi.org/10.1016/j.prostr.2016.06.454>.
- [18] I. Martić, A. Sedmak, N. Mitrović, S. Sedmak, I. Vučetić, Effect of over-pressure on pipeline structural integrity, *Teh. Vjesn.* (2019) <http://dx.doi.org/10.17559/TV-20180708213323>.
- [19] V. Chmelko, D. Biro, Safety of pressure pipe operation with corrosive defect, *Procedia Struct. Integr.* 17 (2019) 520–525, <http://dx.doi.org/10.1016/j.prostr.2019.08.069>.
- [20] P. Trampus, V. Krstelj, G. Nardoni, NDT Integrity engineering - A new discipline, *Procedia Struct. Integr.* (2019) <http://dx.doi.org/10.1016/j.prostr.2019.08.035>.
- [21] ASM International Handbook Committee, *Metals handbook: desk edition*, *Met. Handb.* (1998) <http://dx.doi.org/10.1017/CBO9781107415324.004>.
- [22] G. Vizentin, G. Vukelic, Degradation and damage of composite materials in marine environment, *Medziagotyra* 26 (2019) 337–342, <http://dx.doi.org/10.5755/j01.ms.26.3.22950>.
- [23] N. Azzeddine, A. Benkheira, S.M. Fekih, M. Belhouari, N. Azzeddine, A. Benkheira, S.M. Fekih, M. Belhouari, *Advances in aircraft and spacecraft science*, *Adv. Aircr. Spacecr. Sci.* 7 (2020) 151, <http://dx.doi.org/10.12989/AAS.2020.7.2.151>.
- [24] Y. Ayaz, Çitil, M.F. Şahan, Repair of small damages in steel pipes with composite patches, *Materwiss. Werksttech.* 47 (2016) 503–511, <http://dx.doi.org/10.1002/MAWE.201600526>.
- [25] Š. Pacholková, H. Taylor, Theoretical background of leak-before-break as a concept in pressure vessels design, *Konference. Tanger. Cz.* (2002).

- [26] P. Kannan, K. Amirthagadeswaran, T. Christopher, Development and validation of a leak before break criterion for cylindrical pressure vessels. 231 (2015) 285–296. <http://dx.doi.org/10.1177/1464420715595538>.
- [27] J. Brnic, Analysis of Engineering Structures and Material Behavior, Wiley, 2018.
- [28] DNV GL, Rules for Classification of Ships/High Speed, Light Craft and Naval Surface Craft, part 2, chapter 2, 2012.
- [29] N. Saeed, H. Ronagh, A. Virk, Composite repair of pipelines, considering the effect of live pressure-analytical and numerical models with respect to ISO/TS 24817 and ASME PCC-2, Composites B 58 (2014) 605–610, <http://dx.doi.org/10.1016/j.compositesb.2013.10.035>.