

# On Vessel to Vessel Interaction during Head-on encounter

---

**Brčić, David; Barić, Mate; Mohović, Robert**

*Source / Izvornik:* **Pomorski zbornik, 2017, 53, 35 - 52**

**Journal article, Published version**

**Rad u časopisu, Objavljena verzija rada (izdavačev PDF)**

<https://doi.org/10.18048/5303>

*Permanent link / Trajna poveznica:* <https://um.nsk.hr/um:nbn:hr:187:508522>

*Rights / Prava:* [In copyright](#)/[Zaštićeno autorskim pravom.](#)

*Download date / Datum preuzimanja:* **2024-09-12**



**Sveučilište u Rijeci, Pomorski fakultet**  
University of Rijeka, Faculty of Maritime Studies

*Repository / Repozitorij:*

[Repository of the University of Rijeka, Faculty of  
Maritime Studies - FMSRI Repository](#)



**David Brčić**

E-mail: brcic@pfri.hr

**Mate Barić**

E-mail: mbaric@pfri.hr

**Robert Mohović**

E-mail: mohovic@pfri.hr

University of Rijeka, Faculty of Maritime Studies, Studentska 2, Rijeka, Croatia

---

## On Vessel to Vessel Interaction during Head-on encounter

### Abstract

Interaction of two vessels during head-on encounter acts as short and strong force. Consequences can reflect on vessels' handling causing unwanted effects. This phenomenon was elaborated in the paper, considering influence of interaction force and its dependence on main recognized factors: mutual vessels' distance, speed and depth under the keel. Besides interaction force components, analyses comprised other relevant factors as vessel' heading, course alterations and drift of vessel due to interaction. Planned and, according to main factors, defined scenarios were conducted in navigational simulator with usage of navigational areas creation tools. After simulations and data post-processing, obtained results were summarized. Correlation of results with mathematical relations describing interaction was conducted. In the conclusion chapter, final inferences are stated, with some of observations which in the opinion of authors are significant. Conducted analyses, obtained results and derived conclusions represent basis for further research, thus future activities regarding interaction phenomenon are proposed.

**Key words:** interaction, head-on encounter, maneuverability, drift, depth under the keel

### 1. Introduction

From the maritime safety standpoint, interaction of the vessel with environment acts as a critical factor. The impact of interaction can reflect on vessel's manoeuvrability, course steering, vessel handling and finally, safety of navigation. The vessel can interact with the bottom, the bank and/or with the other vessel, in navigation, berthed or anchored. Consequences of interaction forces manifest in various ways, causing unwanted effects. During interaction uncontrolled vessel's speed and course changes can occur, which in certain conditions can lead to collisions, grounding or shore impact

(Barras 2004). In sequence of maritime accidents, interaction played main or at least great indirect role (Barras *et al.* 1995, Kokarakis & Taylor 2007).

Interaction effects depend on variety of internal (considering own ship) and external (considering the environment) factors. Generally, the limited the space around the vessel, the interaction force acts as more complex and pronounced and, during coupling of various interaction forces one component influences the other. Significant difference in size of two interacting vessels can cause the unwanted behavior of smaller vessel, which can lose the steering ability and collide with other vessel or the shore.

The interaction phenomena has been matter of research since it has been firstly observed - in the collision of RMS Olympic and RMS Hawke in Solent, 1911 (Barras *et al.* 1995). So far, various approaches on interaction were applied: empirical, semi-empirical and mathematical (Vantore *et al.* 2002). Computational fluid dynamics acts as one of the new methods. Although each of approaches gained certain applicable relations resulting in partial mathematical explanations, it is very challenging to establish unique interaction mathematical model due to series of various influential factors. During previous research (Barras 2004, Barras *et al.* 1995), indicative dependencies of interaction with crucial factors were defined, providing guidelines for preventive and corrective actions aiming to mitigation of unwanted consequences.

The new possibility of approaching the interaction issues appeared with the use of navigational simulators. Besides education and training, simulators are nowadays used for research, designing and project planning. Similar as vessel equipment, navigational simulators have to meet defined standards and requirements in order to be accepted and used for respective application. Mathematical algorithms and models of dynamical occurrences and hydrodynamic forces allow reliable insight in outer factors' influence on the movement of specific maritime object.

In the proposed paper, specific case of interaction between two vessels during head-on encounter was elaborated by conducting simulation measurements. Interaction force was singled out, observed as separate, and analyzed. In the analytic description of interaction, results obtained by simulation measurements were used, considering previous documented research results and achievements. Various interaction scenarios were conducted, always considering main influential factors and resulting interaction force dependence: various mutual distances of vessels, various vessel speeds and various depths under the keel, ranging from unlimited to shallow values. In this way, influence of sea bottom was analyzed as significant influential factor on interaction force together with squat effect. Resulting interaction forces were also elaborated in terms of heading (HDG) and course over ground (COG) changes, representing additional indicator of interaction manifestation. Here, two important facts have to be emphasized. First, research results are based on data obtained from simulation measurements which were generated by using mathematical and hydrodynamic models. Second, some of conducted scenarios are unlikely to occur in real situations. As any model, simulations do not represent perfect description of real phenomena occurring during interaction. However, considering developed and certified navigational simulators, as well as

mathematical models examination, similarities of behavior of vessels in accordance with previously derived interaction regularities (explained further) has been confirmed, what was one of the aims of the paper. Influence of interaction forces on vessels auto pilot and hand steering courses and their changes has been analyzed and elaborated as well, results of which are presented through the paper. Simulated scenarios were conducted in order that interaction force during head-on encounter can be thoroughly described and reviewed, considering main internal and external factors. Therefore, extreme situations have been considered as well, such as small mutual distances and their high speeds. It is desirable that these situations do not occur for real.

## 2. Background

Unlike causality, which implies the occurrence of an event as a consequence of the previous one, interaction acts as a concept of two-way effect. It appears when two or more bodies interact with one another, causing changes in them or in their movement. In maritime navigation context, it reflects on vessel's interaction with her static and dynamic environment, leading to changes in her motion. Factors affecting the occurrence and intensity of interaction forces can be classified as follows (Mohović 2006). Internal factors are geometric and constructional vessel features like ship's block coefficient, draft, speed and heading during the interaction process. External factors are represented with features of the area the vessel is sailing - primarily the bottom and the bank. During head-on encounter or overtaking, external factors are also equivalent features of the other vessel, as well as their mutual position. Meteorological and oceanographic factors have to be considered as well: wind, waves and current forces. They do not have direct influence on interaction; however they can favor interaction force increase.

The final feature is human factor. Considering that interaction acts as partially governable force, human factor is essential in correct and timely action aiming at mitigation of even avoidance of the interaction effects. In certain conditions (e.g. narrow channels and shallow waters), potential risk situations are inevitable. This is where application of scientific approach to acting forces acts as essential (Mohović 2006).

Interaction force is caused by vessel's pressure fields, i.e. their distribution around the immersed part of the vessel's hull (Barrass 2004). In calm water, without outer influences (currents) and without developed vessel's speed, these fields are defined with hydrostatic pressure, considering that the vessel is in state of equilibrium (Barrass *et al.* 1995). After the vessel starts to move - developing speed, dynamical (positive and negative) pressure areas appear, distributed around and below the vessel's hull. In this way, areas of horizontal and vertical pressure domains are formed (Figure 1) (Barrass 2004, Barrass *et al.* 1995). This phenomenon is a result of different velocities of water flows around the hull. The flow continuity equation specifies that water streamlines are spreading in front and behind the vessel, while they are mutually approaching at the vessel sides (Vučinić 1997, Mohović 2006). According to simplified Bernoulli equation (Erneux 2009):

$$p + \frac{1}{2} \cdot \rho_v \cdot v^2 = const \quad (I)$$

where  $p$  = pressure;  $\rho_v$  = water density;  $v$  = flow velocity

areas of increased and lowered pressure are formed around the hull. Flow velocity on the vessels fore and aft is smaller than on the sides, resulting in pressure rise at these points (stagnation points) and pressure reduction at vessel sides (Vučinić 1997).

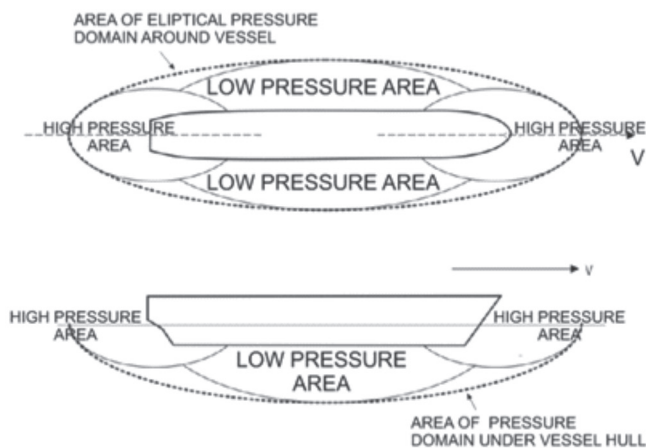

Figure 1: Horizontal (upper image) and vertical (lower image) pressure distribution during vessel's forward movement by which the domain around and below the vessel's hull is defined. Made by authors as interpreted from (Barras 2004)

Pressure distribution as well as horizontal and vertical domain magnitude around the hull will depend on respective vessel features, her current position, speed, acceleration as well as her past movement which is reflected in generated waves pattern (Bertram 2012). As the vessel sufficiently approaches the bottom or the coastline, the domains are overlapping with these areas and interaction becomes to occur. In shallow waters friction resistance increases together with bow and aft generated waves (Vučinić 1997). Accumulated water on the bow results in high pressure area. Accelerated water mass is passing along vessel sides or below the keel is causing the drop of pressure. The same phenomenon occurs when domains of two vessels overlap (Barras 2004). In general, interaction between vessels can occur in two basic cases: during overtaking as weaker but prolonged effect and head-on encounter as shorter and stronger effect. Magnitude and overlapping of vessels domains will govern the intensity of resulting interaction force. According to (Barras *et al.* 1995, Kokarakis & Taylor 2007, Barras 2004) vessel to vessel interaction varies as the square of the speed, inversely with distance increase and roughly as the inverse square root of the Under Keel Clearance

(UKC) to draft ratio. Those relations are generally set, and they are representing the basis of the conducted research in confirming them.

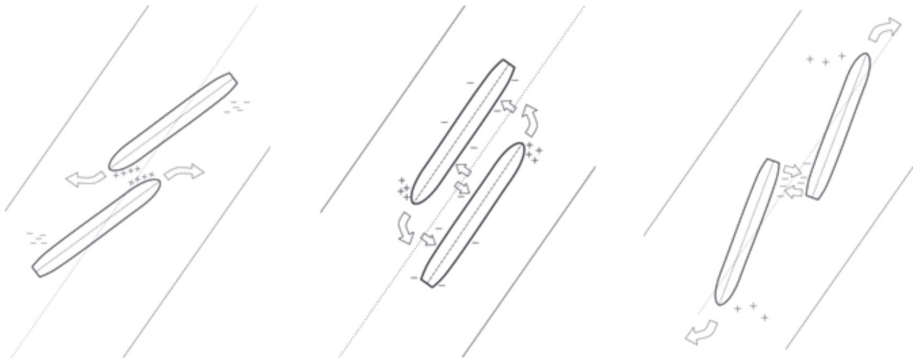

Figure 2: First (left), second (middle) and third (right) head-on interaction phase. Made by authors as interpreted from (Barrass 2004, Rowe 2000).

During head-on encounter developed interaction force acts as stronger and shorter effect when compared to overtaking (Figure 2). According to (Barrass 2004, Rowe 2000), this occurrence can be divided into three main phases. In the first phase, vessel bow waves are approaching, colliding and pushing the vessel's bow. The second phase is marked with water flows abolishment and, in case of small distance between vessels, mutual attraction of vessels due to reduced pressure areas and different pressure distribution along each vessel. This can result in uncontrolled altering of vessel course toward the aft of the second vessel. This is the most intense interaction force during all phases, generated with relative/resultant speed of both vessels. In the last (third) phase, reduced pressure areas are causing attraction of vessels aft and turning bows.

### 3. Methodology, measurements and results

When defining the interaction force, following influential factors have to be considered (Vantorre et al. 2002): own vessel, other vessel, depth, own and other vessels' draft, horizontal distance between vessels hull, drafts of vessels, vessels heading and speed.. Simulations of vessels head-on encounter were conducted in order to analyze and represent interaction forces. Research was conducted by executing simulations in Navigational Full Mission Bridge (FMB) ©Transas Navi-Trainer Professional 5000 simulator (Transas 2011, Transas 2012a, Transas 2012b). Each simulation measurement consisted of the following steps: preparation of elements of specific scenario, computational and visual simulation execution, obtained data storage and further preparation for post-processing. Data extraction frequency was set at one second time resolution. During simulation process, all relevant kinematic and dynamic parameters were elaborated and respective forces and moments, respectively. Transversal component of

interaction was analyzed further, while the longitudinal component was used in the context of interaction analysis and description. Among other parameters, squat effect parameter was used as well as HDG and COG values.

Simulations were executed at open sea, eliminating the bank effect element. Fixed simulation frame consisted of meteorological and oceanographic zero values, same vessel types and same draft. The first simulation set consisted of unrestricted depth, considering vessel speeds of 5, 10, and 15 knots. For each speed scenario, ten different mutual distances were considered – ranging from 10 to 100 meters. The second simulation set was conducted in similar manner, this time considering 25.35 meters of depth, what corresponds to 1.5 of vessels' draft. The third simulation set was conducted at the depth corresponding to 1.1 of vessels' draft (18.59 meters of draft, and 1.69 meters of UKC, respectively).

The final set of simulations was conducted considering gradual depth reduction from unrestricted depth to the value of 18 meters, with 20 meters of mutual distance between vessels and with speed of 10 knots.

### 3.1 General interaction analyses and description

Same vessel model was used for the research, as well as for principal interaction description by using one of the scenarios, as shown in Table 1.

Vessel features	Own vessel	Other vessel
	Aframax Tanker	Aframax Tanker
<b>Length</b>	261.3 m	261.3 m
<b>Breadth</b>	48.3 m	48.3 m
<b>Fore Draft</b>	16.5 m	16.5 m
<b>Aft Draft</b>	16.9 m	16.9 m
<b>Displacement</b>	159 548 t	159 548 t
<b>Block Coefficient</b>	0.81	0.81
<b>Course</b>	180°	000°
<b>Speed</b>	15 kts	15 kts
<b>Mutual distance</b>	10 m	
<b>Under Keel Clearance</b>	1.7 m (depth corresponding the value of 1.1 of the vessel's draft)	

*Table 1: Basic features of vessels used in simulations, together with scenario elements selected for interaction analysis and description.*

For values of the transversal component total averages were taken and analyzed. By using available sources and simulation inferences, interaction force during head-on encounter was analytically described on representative scenario, explanation referring to own vessel. Longitudinal and transversal forces' values during interaction phenomena are presented on Figure 3.

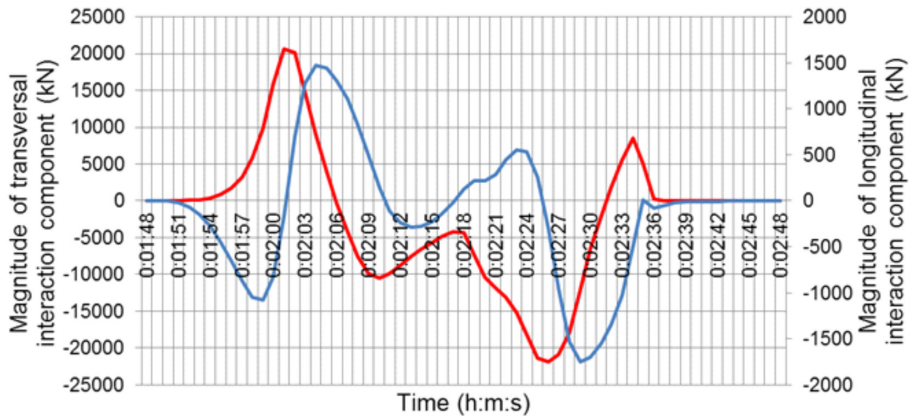

Figure 3: Longitudinal (blue) and transversal (red) component during head-on interaction. Made by authors.

During interaction process, both components gain positive and negative values. Transversal component positive values indicate mutual repulsion of vessels, with negative values indicating their mutual attraction. As for longitudinal component, positive values are indicating vessel acceleration, while negative values are indicating vessel deceleration.

Transversal component acts as significantly stronger and essential for the interaction process, so it will be analyzed in further simulations and results' elaboration. On Figure 4, segmentation of transversal component is shown in more detail than generally described before.

Interaction appears when the vessels' bow waves collide at approximately  $\frac{3}{8}$  of vessel's length (100 meters) (1). The force increases after the bows are parallel, rising until the own vessel bow is parallel with  $\frac{1}{4}$  length of other vessel referring on vessel's fore (2). This is the greatest positive value of transversal interaction force component. After this point the force decreases reaching zero value when the bow is parallel with other vessels'  $\frac{1}{2}$  of length (3). Negative value increases until the bow is parallel with  $\frac{3}{4}$  of other vessel length (4), after which it changes direction towards zero. After vessels' alignment (bow-to-stern), force positive value increases until the own vessel bow passes the stern for approximately  $\frac{1}{4}$  of its length, rising negatively afterwards (5). As vessels pass, the negative value rises until the own vessel stern is parallel with approximately  $\frac{1}{2}$  of other vessel's length (6). In this phase, the interaction (transversal) force and vessels



mutual attraction is strongest. During interaction, vessels' attraction is significantly stronger than their repulsion. After (6) the force changes direction towards zero value and becomes positive when vessels' stern aligns, rising positively further (7). In this, second positive phase the peak force occurs when sterns are distant for approximately 1/10 of vessel's length (8). At the position of mutual distance of approximately 1/5 vessel's length, the force reaches zero value, slightly decreasing in measurable value (9), fading completely on sterns' distance of approximately 2/3 of vessel's length.

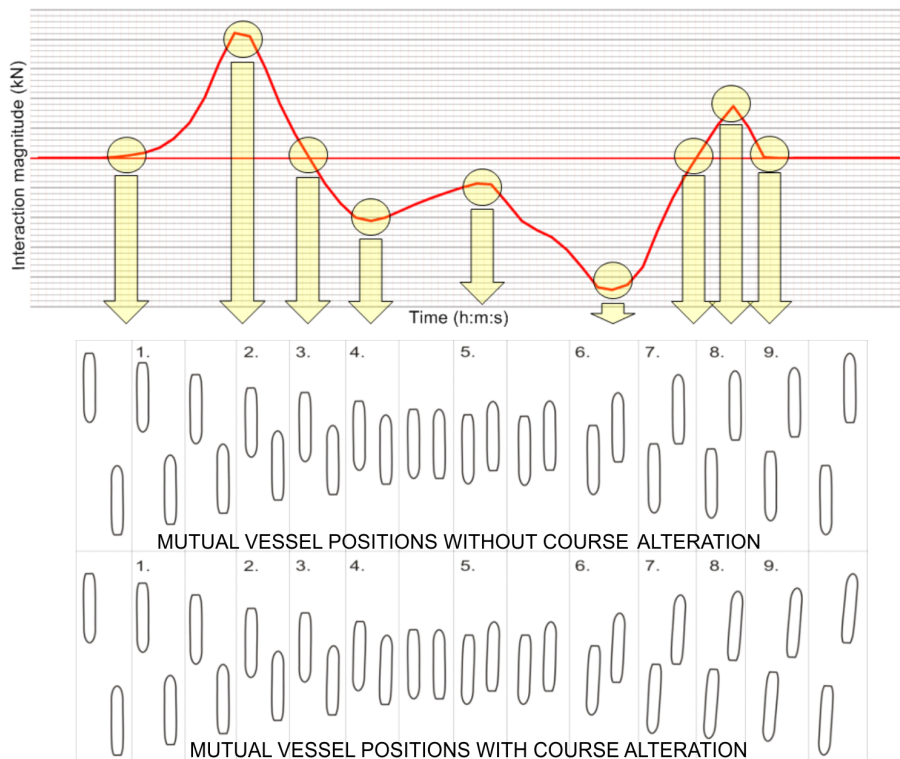

Figure 4: Transversal component of the interaction force during head-on encounter (upper image), with mutual vessel positions during passing. Made by authors.

Effect of interaction can be practically shown with COG and HDG changes and their mutual discrepancies, representing vessels drift caused by interaction. On Figure 5, COG and HDG changes during interaction are shown, with numbers indicating previously defined phases. Figure presents course values obtained in two scenarios, which are automatic and hand steering. Vessels' speed was set at 10 kts, with 20 meters of mutual distance. Autopilot algorithm for course stabilization is based on Proportional–

Integral–Derivative (PID) steering which implies wave filtering of high component of vessels movement. As for disabled autopilot scenario, the simulations were conducted in a way that no corrective actions were taken.

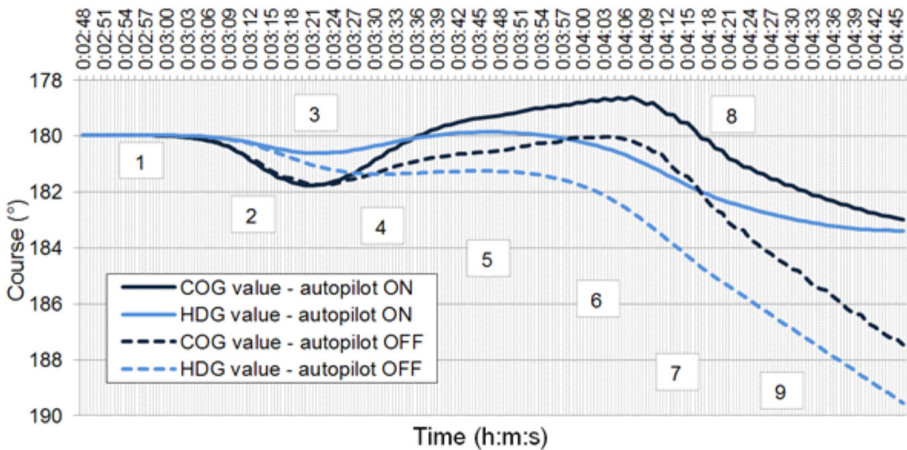

Figure 5: COG and HDG values during head-on interaction process with defined interaction phases. Made by authors.

Firstly, bows are moving away according to bow waves collision (high pressure areas) appearance. COG value rises more than HDG meaning that besides bow repulsion also opposite drift occurs. After the interaction force reaches zero from negative, courses start to decrease. Own vessel high pressure area (bow) overlaps with side of other vessel (low pressure area) resulting in attraction of vessels and negative rise of interaction force. HDG value stabilizes in approximately set value ( $000^{\circ}/180^{\circ}$ ), however COG value raises further indicating drift toward other vessel - this cannot be concluded by observing only HDG. As the own vessel's bow reaches the stern of other vessel, two high pressure areas interact, resulting in cease of attraction, which is evident at the moment when the interaction force changes its sign (positive step within the negative interaction phase). This vessel increment of repulsion can be explained by overlapping of bow/stern high pressure areas. By looking at COG, the drift is still present, however in lesser extent. Afterwards, side (own vessel) and stern (other vessel) overlap resulting in increase of the attraction force and increase of the COG and HDG difference. The biggest difference occurs in the phase when interaction force starts to decline (towards zero from negative). Due to attraction, vessels turn from one another changing heading, however for a certain period course over ground value indicates that drift toward other vessel exists. As the force approaches the positive value, both course values increase clockwise (to the right), HDG value being higher. The drift appears again, this time in opposite direction. Right increase of course values is present until the end of the interaction, even after the interaction force ceases. On Figure 6, differences

between HDG and COG values are shown together with transversal interaction force component behavior.

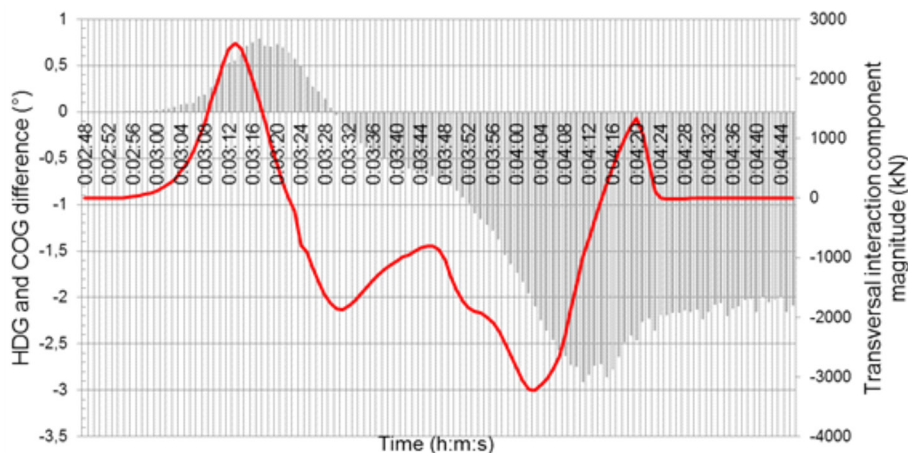

Figure 6: HDG and COG differences (gray) and transversal interaction component magnitude (red) during interaction process.

Course difference follows transversal component of the interaction force magnitude. Although with certain delay, course difference trend behaves in accordance with interaction trend during the whole period. During previously defined *positive step* in negative interaction phase, the course difference declines as well. Largest difference/drift occurs immediately after largest interaction negative value. In the following chapter, results obtained from previously defined simulation scenarios are presented.

### 3.2 Measurement analysis and results

On Figure 7, average interaction force values are presented considering various mutual distances (0 – 100 meters), different vessel speeds (5, 10 and 15 knots) and three representative depths (unrestricted depth – 100 meters, 1.5 of vessel's draft – 25.4 meters and 1.1 of vessel's draft – 18.59 meters).

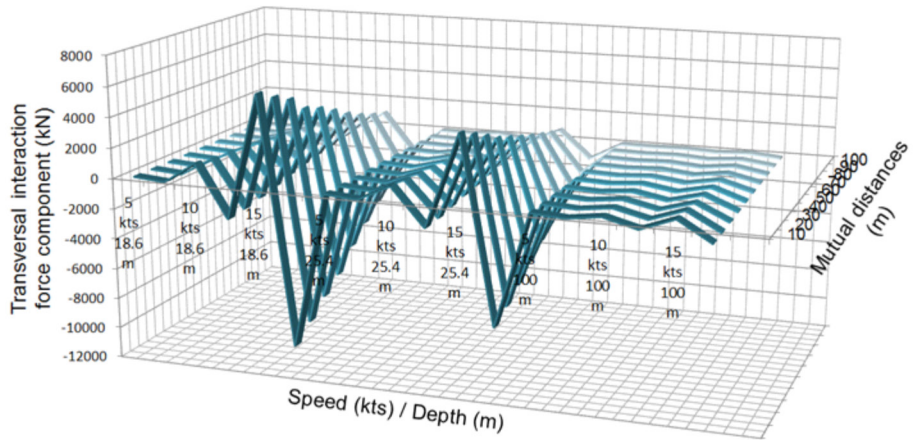

Figure 7: Results showing interaction forces in conducted scenarios. Made by authors.

As to confirm, the interaction force reaches the maximum values at highest relative speed, minimal mutual distance and at the smaller UKC value. When scenarios are rearranged in a way that measurements are sorted by speed in order of depth reduction, results can be shown as on Figure 8.

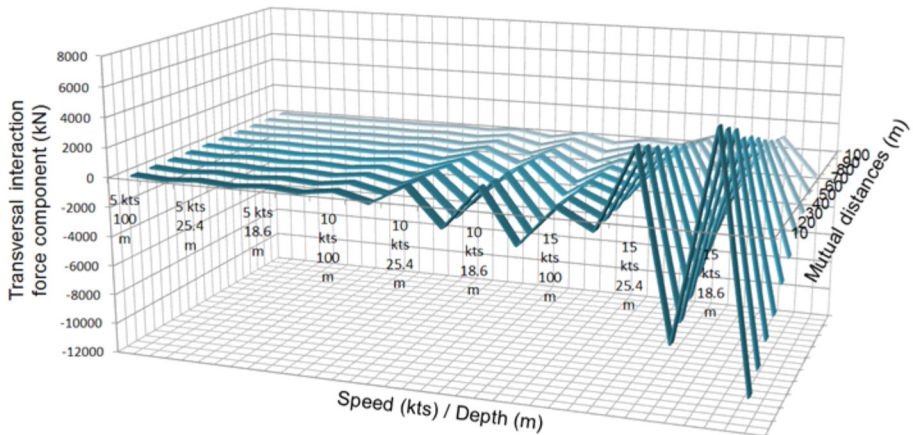

Figure 8: Results showing interaction forces in rearranged scenarios by speed increase and depth reduction. Made by authors.

Comparing Figures 7 and 8, depth influence on interaction is obvious. The interaction force rises as the speed is increasing and mutual distance is decreasing. However, greatest interaction occurs due to UKC/depth reduction. In order to elaborate vessel to vessel interaction behavior in function of depth reduction, new measurements were conducted, as shown further.

### 3.3 Vessel-to-vessel interaction behavior in gradual depth reduction

In the following measurements, head on encounter was simulated with speed of 10 knots and mutual distance of 20 meters, with 16.9 meters of draft (squat effect excluded). The depth under keel was gradually reduced with each following simulation: ranging from 100 meters (representing unrestricted depth) to 18 meters (last possible simulation). Obtained results are shown on Figure 9, together with squat effect values.

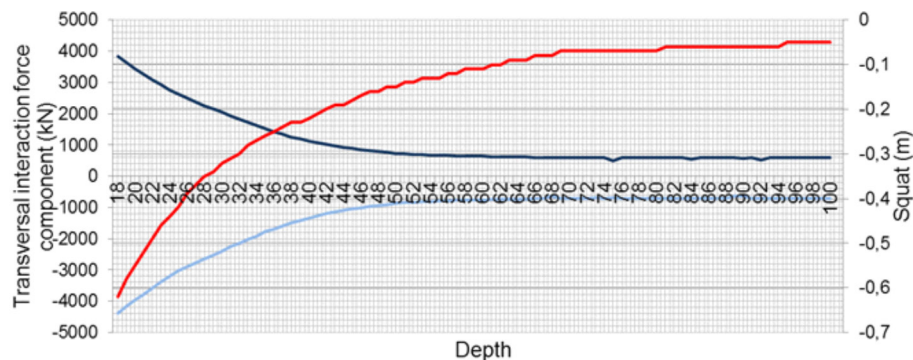

Figure 9: Squat (red), positive (dark blue) and negative (light blue) transversal interaction force components during head on encounter by gradual depth reduction. Made by authors.

Interaction interceptibly increases at the beginning (100 m to the lower). At depth of approximately 52 m, its more prominent rise takes place in both (positive and negative) direction. Therefore, in can be concluded that, in this specific case, significant interaction effect starts at depth value corresponding to 3 drafts of the vessel. On the other hand, pronounced rise in squat effect starts at depth corresponding to 4 vessel's drafts that is approximately 69 meters.

During simulated scenarios, own vessel COG values were analysed as well. Values were recorded from before the interaction commencement to 2 seconds (measurements) after the force ceased. Obtained results are shown on Figure 10. Blue lines are representing COG change pattern at each simulated depth. The red line marks COG change at 52 m limiting depth.

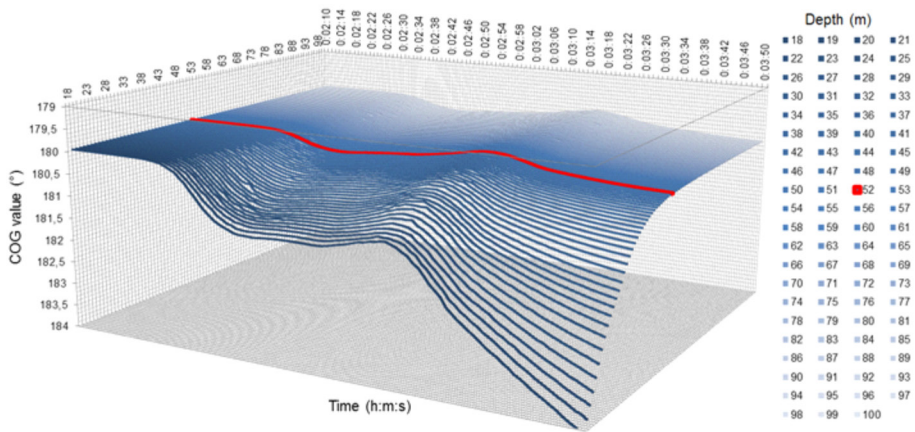

Figure 10: COG values during interaction scenarios with gradual depth reduction. Made by authors.

COG changes compared to course settled on autopilot (180°) are shown on Figure 11. Observations are referring to 100 m (unrestricted depth), 52 m (limiting depth) and 18 m (minimal depth).

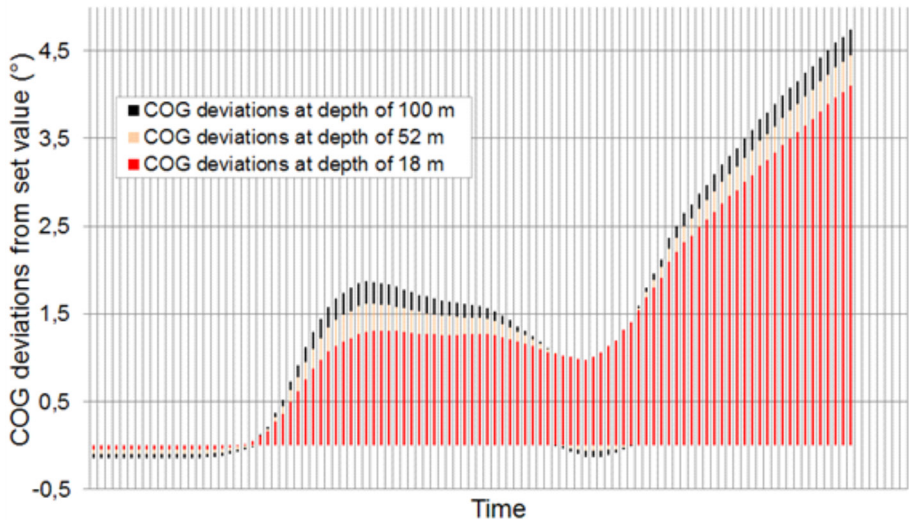

Figure 11: COG values changes regarding to set value of 180° for 100, 52 and 18 m of depth. Made by authors.

Slight but measurable course changes are present at 100 m of depth, oscillating within 0.3° (during complete interaction period). At 52 m, values range inside 0.4°.

Pronounced drift as interaction consequence appears at 2.6 of vessel's draft/1.6 of depth under the keel, i.e. at 45 m of depth.

#### 4. Discussion

This chapter presents the correlation results between defined interaction dependence relations and results obtained from measurements. For this purpose, positive component of interaction force was employed. Approximate relations of interaction in dependence of speed, mutual distance and depth under the keel can be expressed as follows (Dand 1995, Kokarakis & Taylor 2007, Barrass 2004):

$$F \sim v^2 \quad (2)$$

$$F \sim l^{-1} \quad (3)$$

$$F \sim \frac{1}{\sqrt{\frac{UKC}{T}}} = \sqrt{\frac{T}{UKC}} \quad (4)$$

where:

$F$  – interaction force (kN);  $v$  – vessel's speed (m/s);  $l$  – mutual distance of head on vessels (m);  $UKC$  – under keel clearance (m);  $T$  – draft of the vessel (m)

On Figure 12, measured values are compared to expression (2): interaction dependence on speed, where mutual distance was set at 30 m at unrestricted depth, considering speeds of 5, 10 and 15 knots.

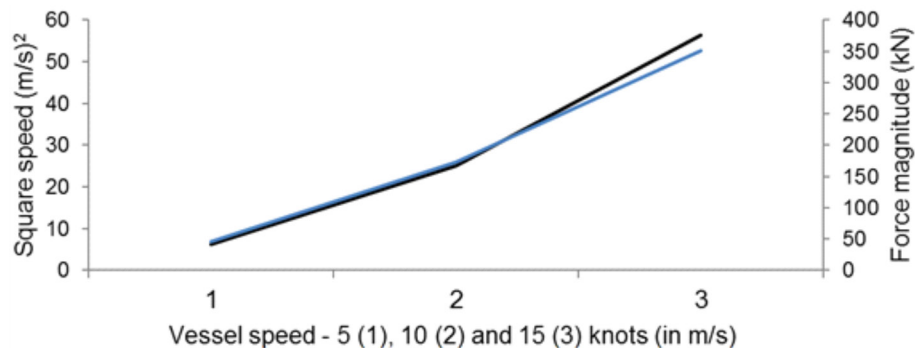

Figure 12: Theoretical (black) and measured (blue) representation of interaction dependence on vessel's speed. Made by authors.

As for mutual distance dependence (2), results are presented on Figure 13. Chosen scenarios were set for all conducted distances (10 - 100 meters by 10 m step), 10 knots of speed and depths of unrestricted depth, 1.5 of vessel's draft and 1.1 of vessel's draft.

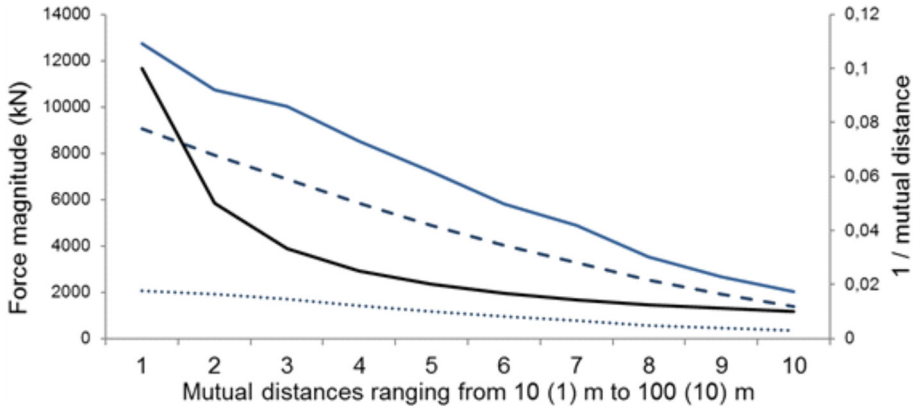

Figure 13: Theoretical (black) and measured representation of interaction dependence on vessels' mutual distance with representative depths: interaction magnitude at unrestricted depth (dotted blue), at depth corresponding 1.5 of vessel's draft (dashed blue) and at 1.1 draft (solid blue). Made by authors.

The third relation (4), least accurate so far (Bertram 2000, Derrett 1999), refers to interaction dependence on depth under the keel. Simulations were set as mutual vessels' distance of 20 meters, 10 knots of speed and gradual depth reduction with every following conducted measurement (100 m to 18 m). In of depth under the keel and vessel's draft ratio computation, squat effect values were taken into consideration. Results are shown on Figure 14.

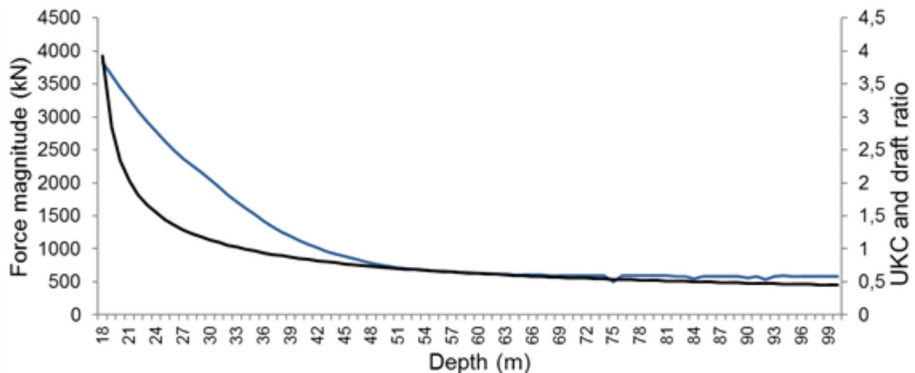

Figure 14: Theoretical (black) and measured (blue) representation of interaction dependence on depth under the keel. Made by authors.



Presented results can be summarized as follows. Best theoretical approximation refers to interaction dependence on speed (Figure 12). Accuracy of mathematical description declines as the depth is reduced. Least accurate approximation regarding vessels' speed occurs at depths of 1.1 of vessel's draft. Fair approximation is confirmed in interaction dependence on vessels' mutual distances (Figure 13), although measurement results are following linearity opposite to theoretical explanation. Greatest deviations between theoretical and measured values are found in expression (4), referring to interaction dependence on depth under the keel. As shown on Figure 14 and Figure 9, approximation is correct until certain depth, roughly the same depth where interaction force becomes more pronounced (52 meters). Moreover, depth reduction influences accuracy of first two relations, as shown before, confirming the significance of depth parameter as main influential factor.

## 5. Conclusion

In the proposed paper, interaction during head-on encounter of vessels was analysed, and its effect on behavior and handling of vessel affected. In relation to previous research, an interaction phenomenon was divided in several characteristic sub-phases, considering mutual positions/directions of vessels during their passing. Interaction dependence on vessel's speed, their mutual distance and depth under the keel was presented and confirmed, presenting main interaction influential factors. Analysis and comparisons were conducted on the basis of previous research and achievements, and stated theses were confirmed by simulation measurements.

Research was conducted by employment of one vessel model, without bank effect and without the influence of outer (meteorological and oceanographic) factors.

Vessel's drift was defined as the difference between heading and course over ground. During interaction occurrence, drift toward as well as away from other vessel was noticed. Here, greatest drift was observed immediately after occurrence of greatest interaction force in negative direction. Besides, considering course over ground change during gradual depth reduction, approximate limiting depth was introduced, after which the drift change started to behave more pronouncedly. It has been shown that increased drift occurs at smaller depth than marked as limiting. Regarding limit values and considering employed vessel model, a practical application of derived results is possible.

The paper presents basis for further research. Concept of interaction is subject to study in a series of segments. Further activities imply different scenarios of passing vessels, restricted navigational areas with bank effect as an additional factor, employment of vessels of different sizes, and interaction between vessel underway and vessel at anchor/berthed ...leading to studying of interaction scenarios specific for certain areas (including vessels, marine environment and meteorological factors). Here interaction between more than two vessels is included, as well as interaction during lightering and interaction influence on acceleration and slowdown (longitudinal component).

Presented mathematical relations serve as general approximation tools, so are they defined. In order to establish more precise interaction dependence pattern, each individual segment of influential factors should be investigated. It would lead to definition of interaction force within satisfactory limit values, approaching in that way the complex, and unique interaction model.

## References

1. Barrass, C.B. (2004), *Ship Design and Performance for Masters and Mates*, Elsevier Butterworth-Heinemann, Oxford, United Kingdom.
2. Barrass, C.B., Dand, I. W., Taylor, M.S. & Walker, J. (1995), *Squat, Interaction Manoeuvring*, The Humberside Branch Seminar. The Nautical Institute, London, UK.
3. Bertram, V. (2000), *Practical Ship Hydrodynamics*, Butterworth-Heinemann, Oxford, UK.
4. Bertram, V. (2012), *Practical Ship Hydrodynamics, second edition*, Butterworth-Heinemann, Oxford, UK.
5. Derrett, D.R. (1999), *Ship Stability for Masters and Mates*, Butterworth-Heinemann, Oxford, UK.
6. Erneux, T. (2009), *Applied Delay Differential Equations: Surveys and Tutorials in the Applied Mathematical Sciences*, Springer, New York, USA.
7. Kokarakis, J. E. & Taylor, R. K. (2007), Hydrodynamic Interaction Analysis in Marine Accidents, *Proceedings of the International Symposium on Maritime Safety, Security and Environmental Protection*, September 20th – 21st, Athens, Greece.
8. Mohović, R. (2006), *Maritimna sigurnost broda: Projektne zadatke, autorizirana skripta*, Pomorski fakultet Sveučilišta u Rijeci, Rijeka, Hrvatska.
9. Rowe, R.W. (2000), *The Shiphandler's Guide*, The Nautical Institute, London, UK.
10. Transas (2011), *Description of Transas mathematical model V 02.08*, Transas© Ltd., Saint Petersburg, Russia.
11. Transas (2012), *Navi-Trainer Professional 5000: Navigational Bridge V 5.25*, Transas© Ltd., Saint Petersburg, Russia.
12. Transas (2012), *Transas Navigational Simulators*, Transas© Ltd., Saint Petersburg, Russia.
13. Vučinić, A. (1997), *Hidrodinamika plovniha objekata (Otpor i propulzija broda)*, Sveučilište u Rijeci, Tehnički fakultet, Rijeka, Hrvatska.

David Brčić, Mate Barić, Robert Mohović

## O međudjelovanju brodova uslijed mimoilaženja

### Sažetak

Međudjelovanje između brodova prilikom mimoilaženja nastupa kao kratkotrajna i snažna sila, čije se posljedice mogu odraziti na upravljivost broda i prouzročiti neželjene učinke. Ovaj fenomen obrađen je u radu, pri čemu se razmatrao utjecaj sila i ovisnost interakcije o glavnim prepoznatim utjecajnim čimbenicima: međusobnoj udaljenosti brodova, brzini kretanja te dubini ispod kobilice. Osim komponenta sile interakcije, razmatrao se i čimbenik smjera kretanja broda, odnosno promjene kursa i zanos uslijed nastupa sile interakcije. Isplanirani i, prema glavnim čimbenicima, definirani scenariji izvršeni su mjerenjima uporabom navigacijskog simulatora i alata za kreiranje plovidbenih područja. Nakon izvršenih simulacija i obrade prikupljenih podataka, sažeto su prikazani dobiveni rezultati. Izvršena je korelacija rezultata s matematičkim odnosima kojima je ovisnost interakcije opisana u ovisnosti o ključnim čimbenicima. U zaključku rada rezimirani su rezultati istraživanja, te su navedena neka od zapažanja koja su po mišljenju autora značajna. Izvršeno istraživanje, dobiveni rezultati i izvedeni zaključci predstavljaju temelj za daljnja istraživanja fenomena interakcije, stoga su ovdje navedene moguće i planirane aktivnosti.

**Ključne riječi:** interakcija, mimoilaženje brodova, upravljivost, zanos, dubina ispod kobilice