

Seawater exposure effect on crashworthiness of CFRP tubes

Načinović, Tino

Master's thesis / Diplomski rad

2024

Degree Grantor / Ustanova koja je dodijelila akademski / stručni stupanj: **University of Rijeka, Faculty of Maritime Studies, Rijeka / Sveučilište u Rijeci, Pomorski fakultet**

Permanent link / Trajna poveznica: <https://um.nsk.hr/um:nbn:hr:187:328233>

Rights / Prava: [In copyright](#) / [Zaštićeno autorskim pravom.](#)

Download date / Datum preuzimanja: **2024-08-08**



Sveučilište u Rijeci, Pomorski fakultet
University of Rijeka, Faculty of Maritime Studies

Repository / Repozitorij:

[Repository of the University of Rijeka, Faculty of Maritime Studies - FMSRI Repository](#)



Seawater exposure effect on crashworthiness of CFRP tubes

Tino Načinović^{1*}, Goran Vukelić¹, Benjamin Mihaljec¹, Ljubomir Pozder¹

¹ University of Rijeka, Faculty of Maritime Studies, Studentska 2, 51000 Rijeka, Croatia

* Correspondence: tino.nacinovic.ilr@gmail.com

Abstract: This study investigates the effects of seawater exposure on the crashworthiness of two types of carbon/epoxy composite tubes under quasi-static compression. Carbon/epoxy composites, widely used in maritime structures due to their high strength-to-weight ratio and corrosion resistance, may experience altered mechanical properties when exposed to harsh marine conditions. To evaluate these effects, quasi-static crushing tests were conducted on composite tubes after a one-month exposure to natural seawater. Composite tubes were manufactured using hand layup and prepreg technique. By analyzing the behavior of these composite structures under controlled compression, the study aims to provide insights into their structural integrity in marine environment. Results indicate a significant impact of seawater exposure on the crashworthiness of carbon/epoxy composites. The maximum compression force is considerably lower after the exposure, and hand layup specimens generally withstand the exposure much better than prepregs. The findings contribute to a deeper understanding of material behavior in marine applications, offering practical guidelines for designing and maintaining composite-based maritime infrastructure.

Keywords: composites, CFRP, material degradation, sea environment, crashworthiness

1. Introduction

With its inherent challenges and demands, the maritime industry continuously seeks innovative materials and designs to enhance safety and performance. Among these materials, carbon/epoxy composites have gathered significant attention due to their exceptional strength-to-weight ratio and resistance to corrosion [1]. However, the interaction of such composites with the marine environment remains relatively underexplored, particularly concerning their crashworthiness. Crashworthiness, one of the critical aspects in marine engineering, determines the ability of structures to absorb energy and mitigate damage during impact events, such as collisions or grounding [2]. Carbon/epoxy composite tubes, often employed in marine structures like ship masts, risers, and subsea pipelines [3], face varying environmental conditions, including exposure to seawater, which may influence their crashworthiness characteristics [4].

Moreover, recent studies have underscored the significance of thermal aging on the mechanical behavior of carbon/epoxy composites. Sebaey's experimental investigation into the quasi-static crushing of carbon-fiber reinforced polymer (CFRP) composite cylindrical tubes after thermal aging provides valuable insights into how thermal exposure can affect the crashworthiness performance of composite structures [5].

This paper presents a detailed overview of the experimental setup, methodologies, and outcomes of our investigation into the effects of exposure to the sea environment on the crashworthiness of carbon/epoxy composite tubes under quasi-static compression. By integrating insights from previous studies, including Sebaey's research on thermal exposure, as well as the comprehensive reviews by Liu et al. [6], where the results showed reductions in both the stiffness and strength due to the increase in

temperature, Cao et al. [7] studied the effect of temperature on the tensile properties of different types of FRP, and concluded that the tensile strengths are dramatically reduced as a function of increasing temperature. Feng et al. [8] investigated the flexural properties of the glass/epoxy composites at different exposure times and temperatures. The results showed that the longitudinal flexural modulus increased by 11% after exposure to 90 days. Mahdi et al. [9] studied the effect of fiber orientation on the quasi-static crushing test and concluded that fiber orientation of 15° - 75° is the best in terms of the load-carrying capacity. Palanivelu et al. [10] reported that the triggering is important for steady state post-crushing, while Chiu et al. [11] studied the crushing behavior of composite tubes at different strain rates and concluded that the energy absorption is independent of strain rate. Experimental investigation into quasi-static crushing of CFRP composite cylindrical tubes after thermal aging was carried out by Tamer A. Sebaey et al. [12], and the results did not show any dependency of the load-displacement profile nor the apparent crushing mechanism on the applied thermal aging. Rubino et al. [13] found that due to their low weight, high specific mechanical properties, and resistance to the aggressive seawater environment, composite materials have proved to be a suitable alternative to metals in offshore applications.

Understanding the effects of marine environment exposure on the crashworthiness of carbon/epoxy composite tubes is important for ensuring marine structures' structural integrity and safety [14]. The motivation for this research came from preparing the boat for the Monaco Energy Boat Challenge. The aim was to build a composite cockpit for the racing boat for this annual student competition. During production, a change in the behavior of composite tubes was noticed after the tubes were in contact with the seawater. This matter is more thoroughly investigated in this paper, where the effect of exposure to natural seawater on crashworthiness is studied. The structure of racing boats is subject to compression loads, which, in combination with the harsh effects of the marine environment, can cause failures. Insights gained from this research will contribute to advancing the understanding of composite behavior in marine environments and allow the development of robust and safe maritime structures. To the best of the author's knowledge, there is no available study in the literature that assesses the crashworthiness of CFRP tubes after seawater exposure.

2. Materials and Methods

The materials used for the first manufacturing method in this study is a commercially available "210g Plain Weave 3k Carbon Fibre Cloth" that is used in a roll-wrapped hand layup technique to make a tube from which specimens were cut using handheld tools to the following dimensions: 50 mm in height with an inner diameter of 32 mm. The material used for the second method in this study is "XC110 210g 2x2 Twill 3k Prepreg Carbon Fibre". The same roll-wrapped procedure was used to make a tube, which was then cured in an oven at 120°C for an hour and 30 minutes, following the manufacturer's recommendations. A comparison of the main material properties is shown in Table 1, with material data taken from [15,16].

Table 1 Properties of materials used [15-16]

	Plain Weave Carbon Fibre Cloth	XC110 Prepreg Carbon Fibre
Aerial weight	210 g/m ²	210 g/m ²
Tensile strength	4120 MPa	521 MPa
Tensile modulus	234 GPa	55.1 GPa

The specimens were cut from the tube using handheld power tools. Figure 1 shows the dimensions of the specimens, Figure 2 shows cut and labeled specimens, and Figure 3 shows specimens prepared and submerged under seawater. The length of the specimens is selected to optimize the material resources, maintain reasonable crushing stroke, and avoid global buckling of the specimen. Six specimens were manufactured using the hand layup technique (marked with hl – “hand layup”), with three of them kept as the control specimens at room temperature (marked with RT – “room temperature”), and three of them submerged into the sea (marked with SW – “seawater”). Another six specimens were manufactured using carbon fiber prepreg material (marked with pp – “prepreg”), with three of them kept as the control specimens at room temperature (marked with RT – “room temperature”), and three of them submerged into the sea (marked with SW – “seawater”). Dimensions and weight of the specimens are presented in Table 2. Values marked with “SW” represent specimens that were submerged in seawater for a period of 30 days. Specimens were submerged in Adriatic Sea, Plomin Luka, Croatia at a dept of 1 meter, in spring during the month of May with the average sea temperature for that location being 17 °C [17]. A period of 30 days of exposure is chosen as minimal that can have an impact on the material, and it is an average period of the exposure of racing boat to the marine environment before the competition.

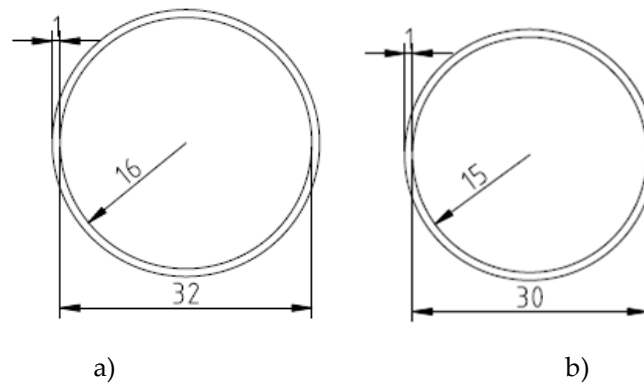

Figure 1 Dimensions of specimens [mm]: a) hand layup, b) prepreg. The length of all specimens is equal to 50 mm.



Figure 2 Cut and labeled specimens



Figure 3 Specimens a) prepared, and b) submerged under seawater

Table 2 Dimensions and weight of the specimens

NUMBER	WEIGHT [g]	DIMENSIONS ($l \times d$) [mm]
1ppSW	3,43	46,9 x 31,0
2ppSW	3,42	47,7 x 30,9
3ppSW	3,40	47,5 x 31,0
4pp	3,59	50,6 x 31,0
5pp	3,48	48,7 x 31,1
6pp	3,74	52,1 x 31,2
9pp	3,09	43,3 x 31,0
10hlSW	4,64	47,4 x 34,0
11hlSW	4,39	46,6 x 33,9
12hlSW	4,60	49,7 x 33,7
15hl	4,56	48,9 x 33,9
16hl	4,76	49,6 x 33,8

As the exposure time was relatively short, notable changes in dimensions and weight were not recorded. Figure 4 shows visual changes on the specimen's surface due to marine growth accumulation.

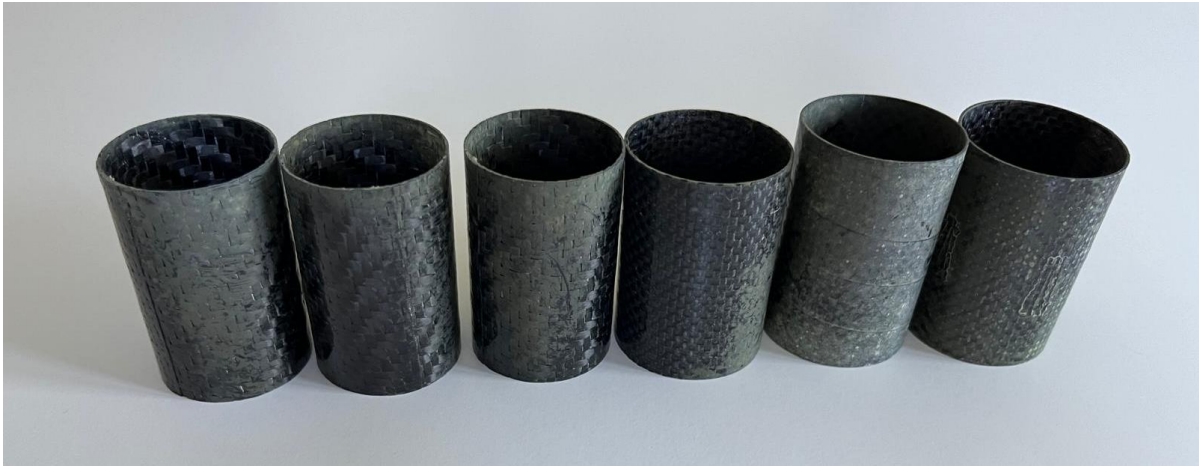

Figure 4 Specimens after seawater exposure

Quasi-static crushing tests were carried out to observe the failure patterns and evaluate the crashworthiness of composite tubes after exposure to the marine environment. The tests were performed using the Hegewald & Peschke Inspekt 20-1 testing machine, which has a load capacity of up to 20 kN. Before the test started, two steel plates were aligned parallel to each other, following a standard procedure for compression tests [18]. The data acquisition system of the universal testing machine logs the load-displacement measurements at a constant speed of 5 mm/min, following the method described in previous references [12]. Figure 5 illustrates the test setup and the specimen used.

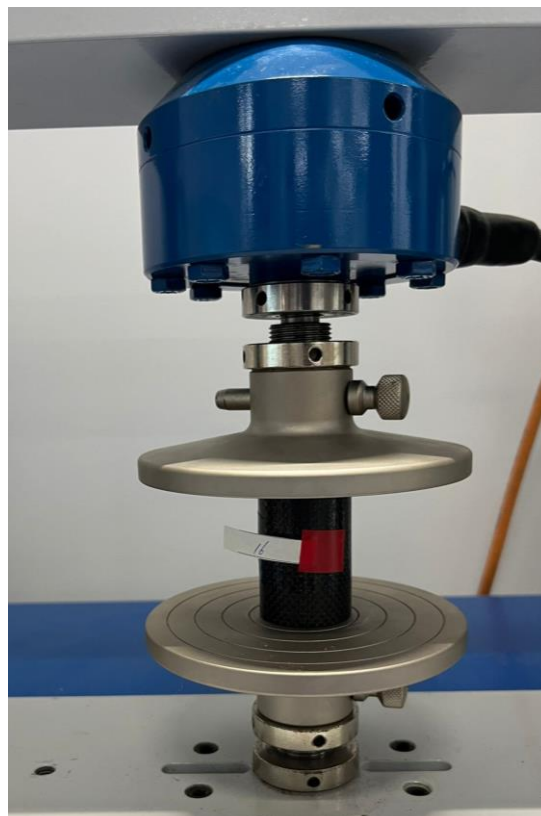

Figure 5 Test setup

3. Results

The results of the test are presented in the form of load-displacement diagrams. Load represents the force provided by the testing machine in newtons, and displacement represents the physical position recorded by the testing machine in millimeters.

3.1. Room temperature specimens results

Diagram presented on figure 6 shows a load-displacement curve for test specimens 15 and 16 (hand layup method, room-temperature environment). The force starts rising linearly as the specimen endures the elastic deformation phase. Peak force (P_i) for specimen 15 is measured at 8524 N, and for specimen 16, it is 8987 N, thus the average being 8756 N. A considerable drop in the load is recorded after this point, which is the beginning of the post-crushing stage.

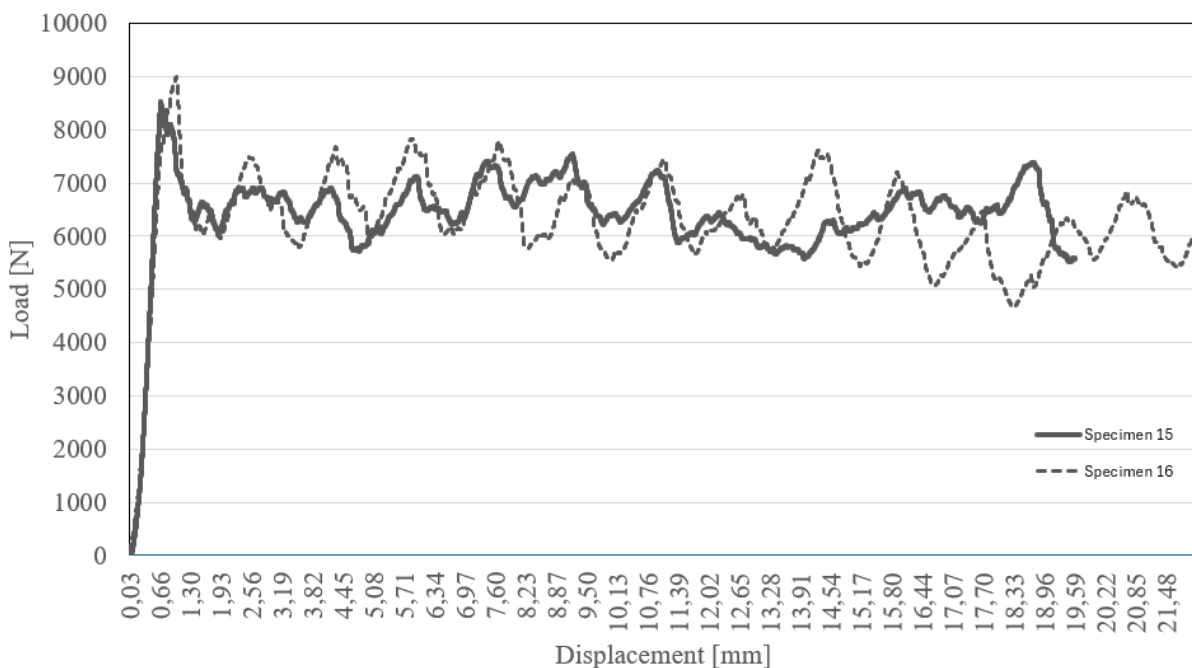

Figure 6 Behaviour of specimens made with hand layup technique and kept at the room temperature

Figure 7 shows a load-displacement diagram for specimens 6 and 9, both made from prepreg material and kept at room temperature. Similar behavior and P_i can be noted between prepreg material and the hand layup process. P_i for specimen number 6 is 8694 N, and for specimen number 9, it is 9015 N, the average P_i for prepreg material subjected to room temperature is 8855 N.

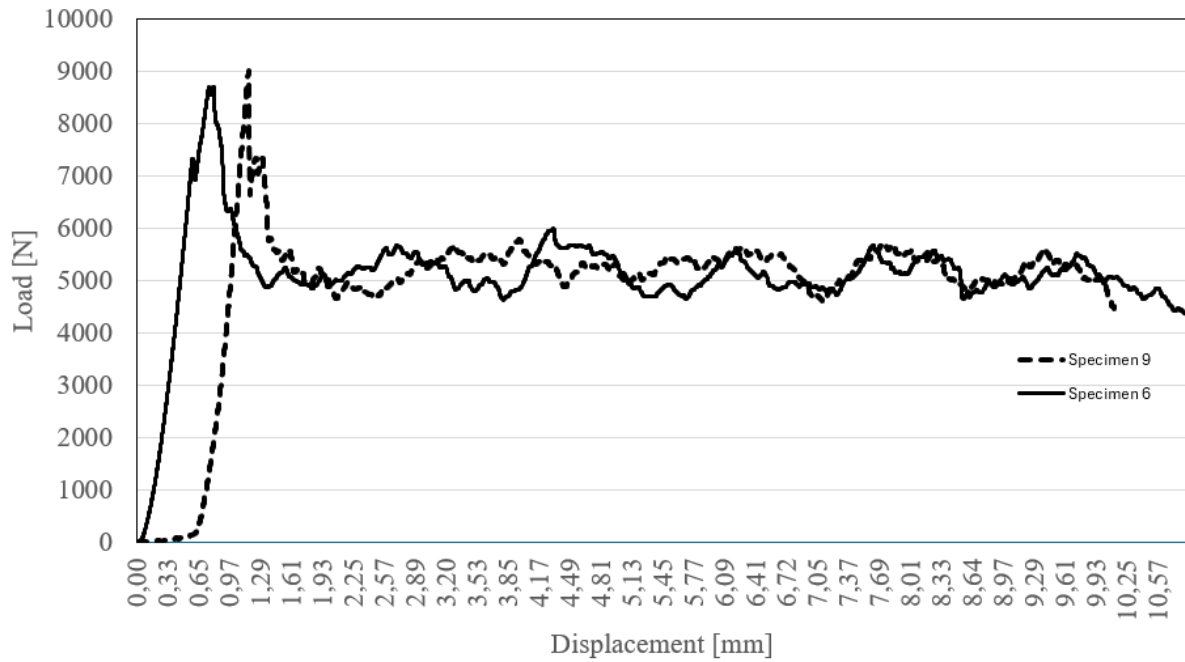

Figure 7 Behaviour of specimens made with prepreg technique and kept at the room temperature

3.2. Seawater specimen results

Load-displacement diagram of test specimens number 10 and number 12 is presented on figure 8. Specimens were made using a hand layup method and exposed to a seawater environment for a period of 30 days. The same general behavior can be noted in specimens kept in a room-temperature environment. The maximum load value for test specimen number 12 is 6809 N, and for specimen number 10 is 6943 N; thus, the average P_i is 6877 N.

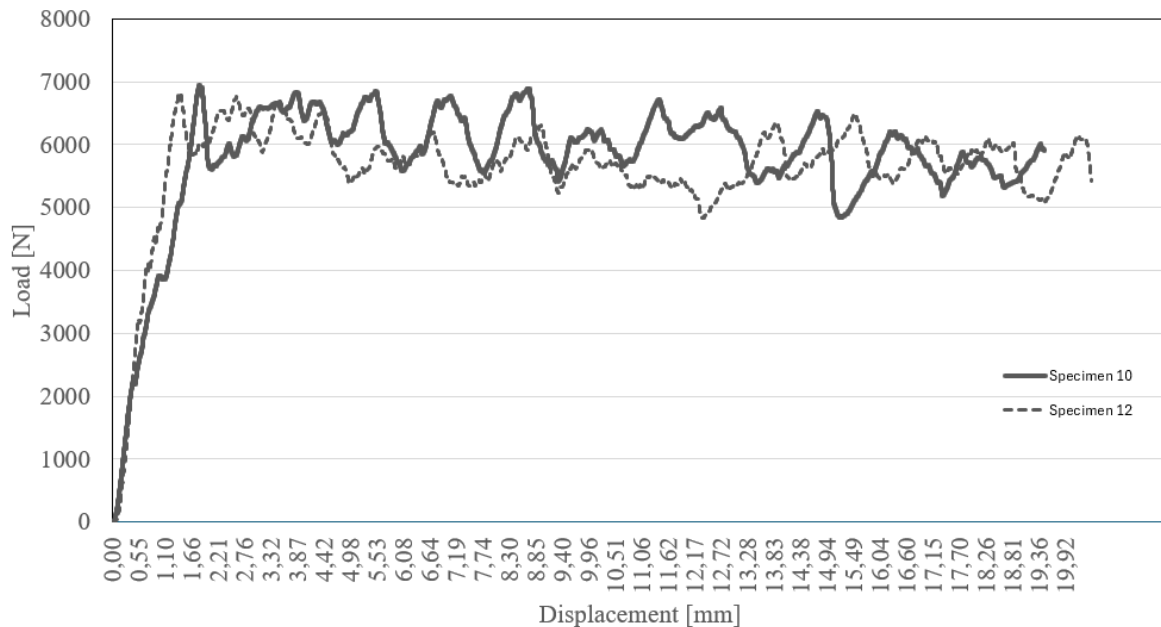

Figure 8 Behaviour of specimens made with hand layup technique and exposed to seawater

Figure 9 shows a load-displacement diagram for specimens 1 and 2. Specimens were made using prepreg material and subjected to a seawater environment for 30 days. P_i for specimen number 1 amounts to 9180 N and 8078 N for specimen number 2, thus the average being 8629 N.

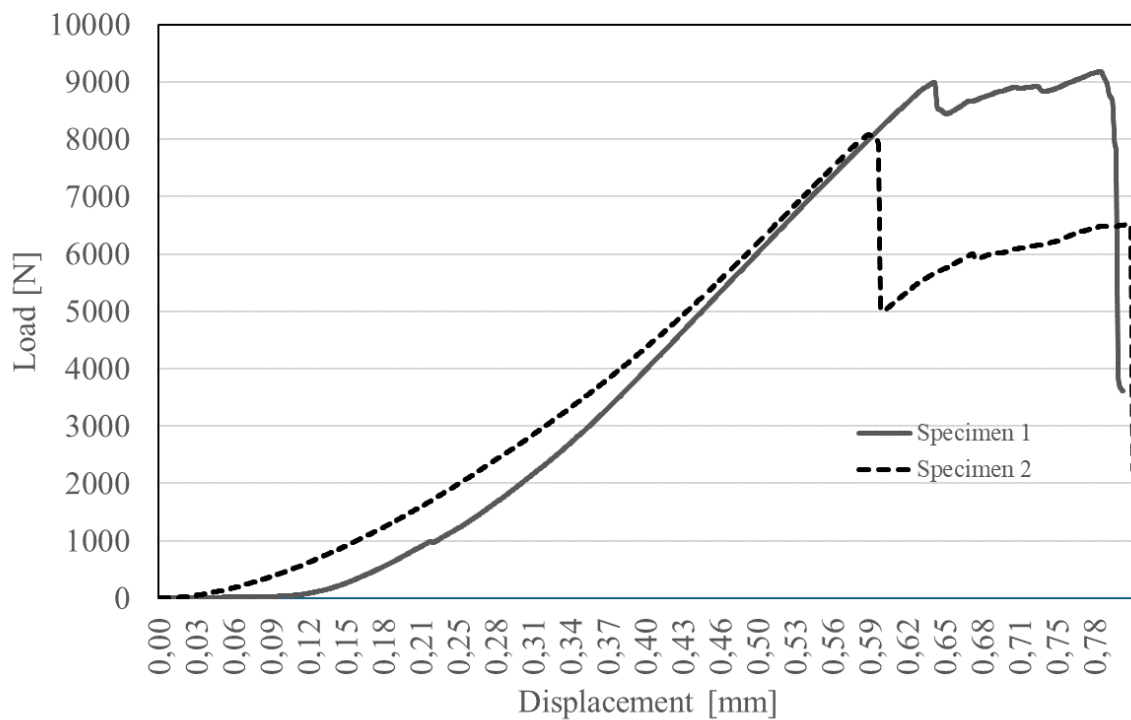

Figure 9 Behaviour of specimens made with prepreg technique and exposed to seawater

Figure 10 shows a prepreg material specimen subjected to a marine environment after the test. A clean crack is visible in the middle of the specimen, and there is no buckling in the post-crushing stage because the load dropped under 50% of the peak load value.

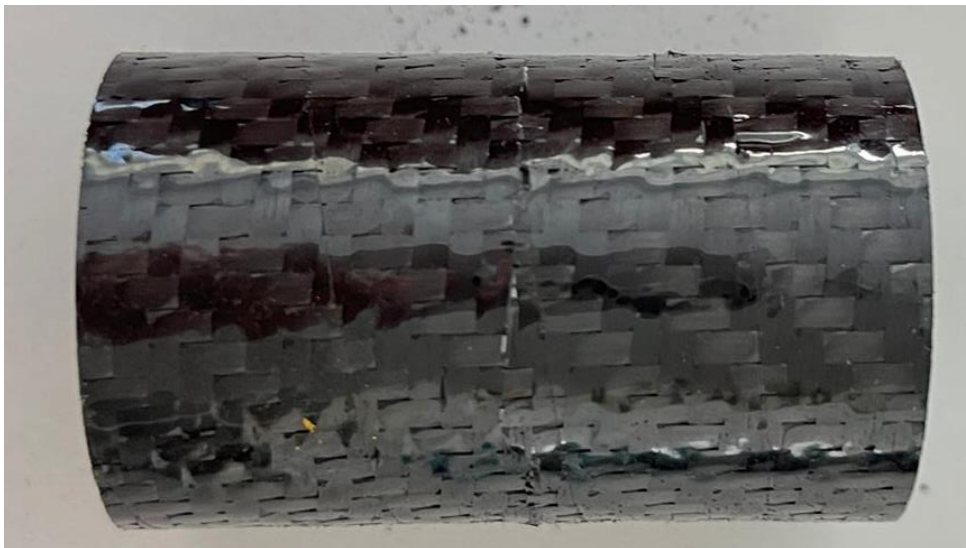

Figure 10 Prepreg material specimen - seawater environment test

4. Discussion

During the post-crushing stage behavior observed in all specimens followed, most of the well-known damage mechanisms (matrix cracking, fibre-matrix debonding, fiber micro buckling, delamination, and fiber failure) start to show on the test specimen and interact to form the load-displacement profile

[19,20,21], visible on figure 11. Due to the specimen buckling, force tends to rise and fall in a repeating pattern, but the force is always lower than the P_i .



Figure 11 Damage mechanisms

Figure 6 presents a diagram for two specimens kept at room temperature conditions made using the hand layup technique. Similarities can be noted, which proves the consistency of the test. The post-crushing stage explained earlier can also be seen in Figure 6.

Figure 12 shows an average result for hand layup method specimens exposed to seawater compared to the average result for hand layup method specimens kept at room temperature conditions. Similar behavior in terms of load-bearing characteristics is present. A notable difference is in peak load force; for specimens exposed to seawater, the average peak force is 22% lower than the average load force for specimens kept at room temperature conditions. The conclusion for the hand layup method is that seawater has a negative effect on the maximum load-bearing capacity of material but does not affect how the material behaves under progressively increasing load.

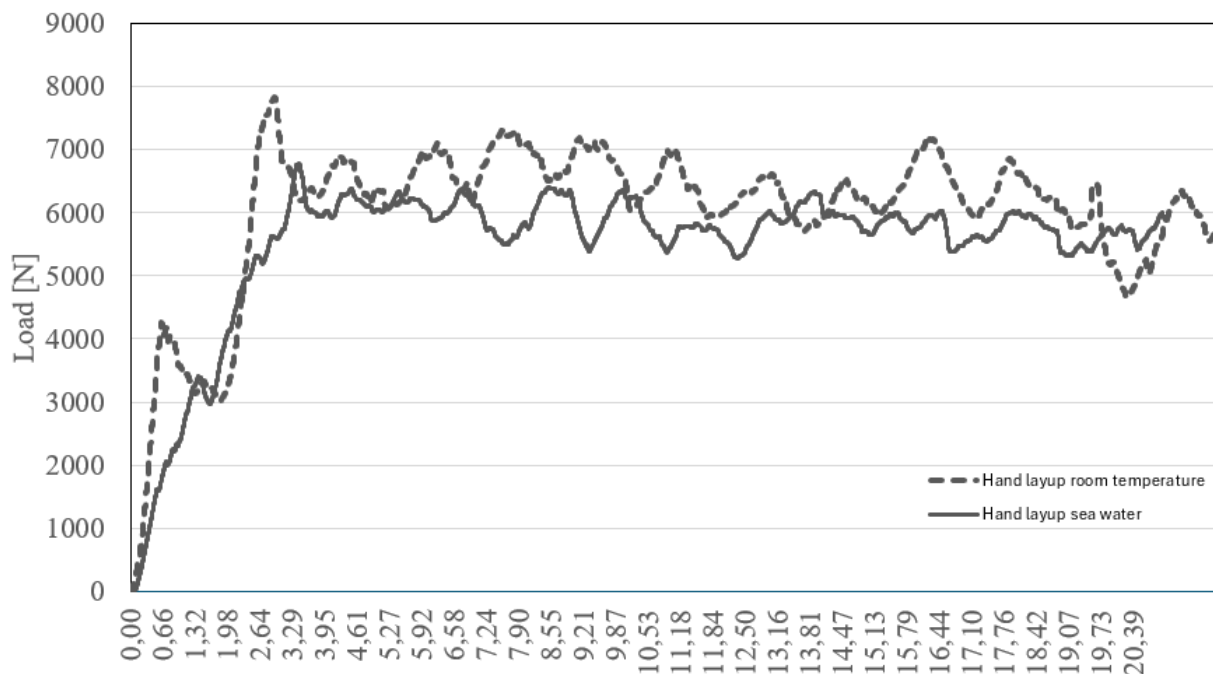

Figure 12 Average hand layup method comparison

Figure 13 shows an average result for prepreg material specimens exposed to seawater compared to the average result for prepreg material specimens kept at room temperature. Different behaviors in load-bearing capacity can be seen with fluctuation in peak load force, but more notable is a rapid decrease of the capability to bear a load greater than 50% of peak load. There is a slight decrease in peak

load force; for specimens exposed to seawater, the average peak force is 3% lower than the average load force for specimens kept at room temperature conditions. That it considerably smaller difference than for the specimens made using hand layup technique, which leads to conclusion that prepregs retain the capability of carrying peak force better than hand layup material after being exposed to seawater for one month. Also, the displacement of the sample exposed to seawater is significantly shorter than the one kept at room temperature, there is only one buckling peak after which load drops under 50% of the initial load and the test is stopped. This can be explained as the seawater environment affecting prepreg material in a way that makes it more brittle and unstable.

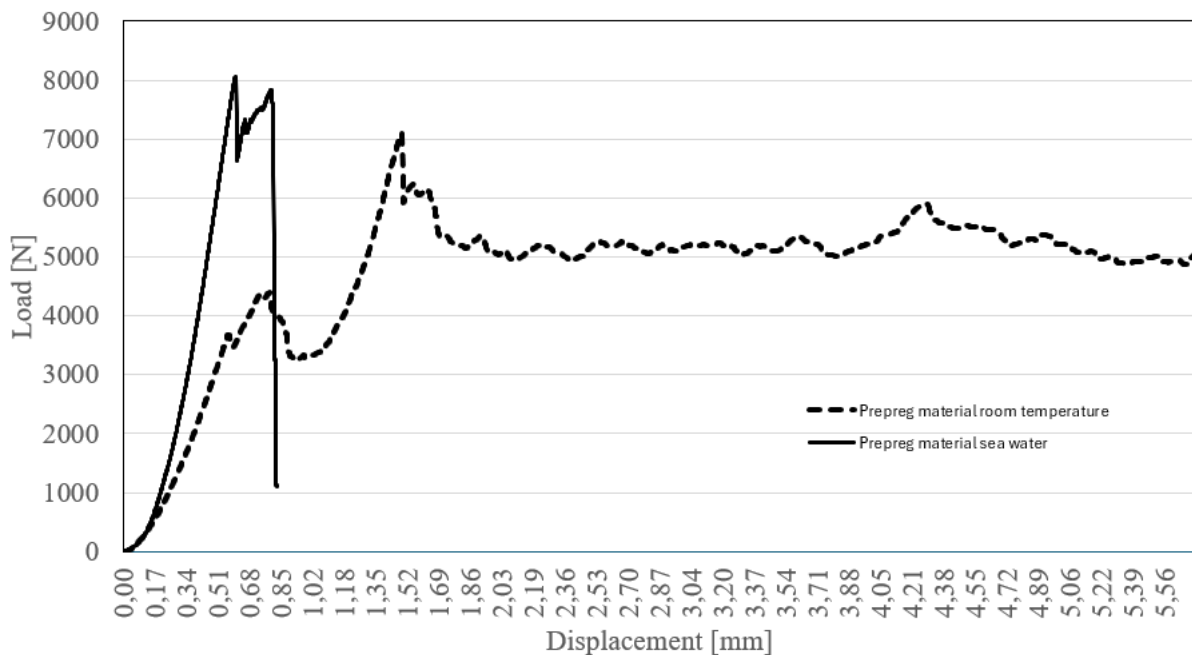

Figure 13 Average prepreg material comparison

Figure 14 shows an average result for prepreg material specimen exposed to seawater compared to average result for hand layup specimen exposed to seawater. The most notable difference is in the displacement of the specimen. Prepreg material specimen endured a lot less of displacement than hand layup specimen therefor concluding that prepreg material in seawater gets a lot more brittle than hand layup specimen. P_i is higher for prepreg material which is consistent with the other results of this study.

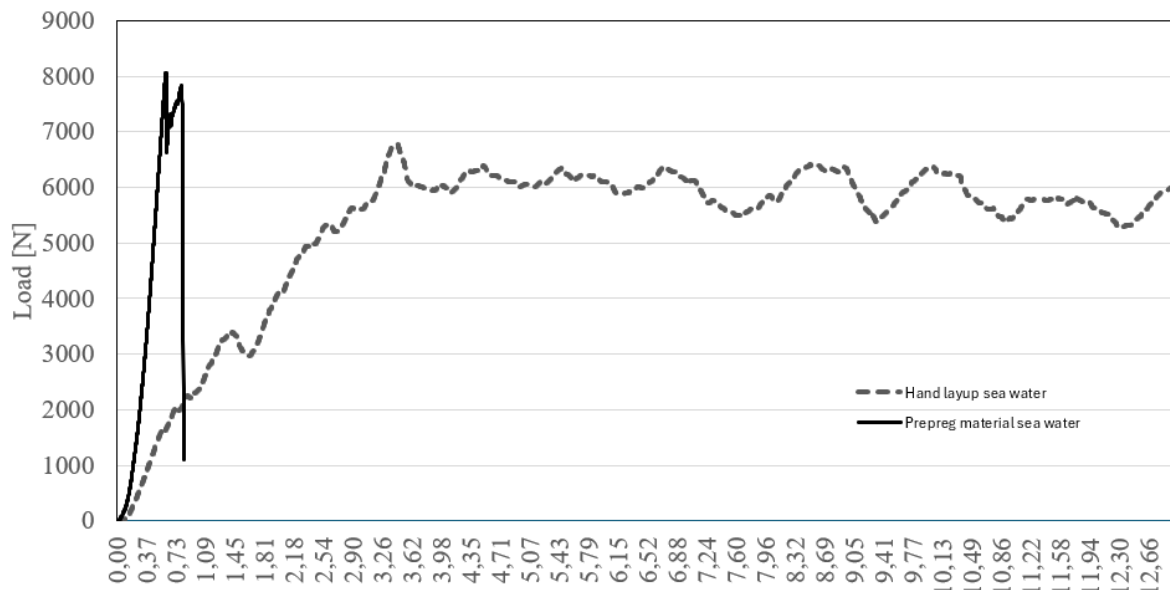

Figure 14 Average prepreg and average hand layup samples exposed to seawater comparison

5. Conclusion

This paper presented an experimental study investigating the effect of seawater exposure on the crashworthiness of carbon fibre-reinforced tubes made using a hand layup method and using a prepreg material cured in the oven. Specimens were subjected to real marine environment, i.e. submerged into the seawater for a period of 30 days and tested in addition to tests done on specimens kept at room temperature conditions. Even after a relatively short exposure period, notable differences can be seen in the test diagrams.

For hand layup method general behavior of specimen under load did not differ in correlation to sea exposure or room temperature conditions but difference can be seen in average peak force being 22% lower for the specimens that were exposed to sea water environment.

For prepreg material, the differences are even more noticeable than for the hand layup technique. Peak force is not consistent between two test samples under seawater, and displacement is significantly shorter compared to room temperature samples. Prepreg material got more brittle and unstable after seawater exposure.

In both instances, it can be concluded that seawater had a negative effect on test specimens, lowering the load-bearing capacity of the composite tubes and threatening their crashworthiness. Further research could go toward performing the experiment for a longer duration of exposure – 3, 6, and 12 months of exposure. Also, combined exposure to seawater and UV light would be interesting since the construction is used in marine environments. Experiments could also be repeated in the winter period to see the effect of seawater temperature on the mechanical properties of the tubes. This research is the first step in the direction of investigating the behavior of CFRP tubes in the marine environment.

Author Contributions: Conceptualization, T.N., Lj.P. and G.V.; methodology, G.V.; investigation, T.N. and Lj.P.; resources, Lj.P. and G.V.; data curation, B.M.; writing—original draft preparation, T.N.; writing—review and editing, G.V and B.M.; supervision, G.V.

Funding: This paper was funded under the project line ZIP UNIRI of the University of Rijeka, for the project UNIRI-ZIP-2103-2-22 “Marine Composite Material Recycling and Re-use”.

Acknowledgments: I want to extend my sincere gratitude to “Udruga Primjenjenih Tehničkih Znanosti” (Association of Applied Technical Sciences) Rijeka for providing the materials used in this study, and for their guidance and support.

References

1. Gibson, R. F., Principles of Composite Material Mechanics. CRC Press, (2010).
2. Zhang, X., & Lu, G., Crashworthiness Design of Marine Structures: A Review. *Ocean Engineering*, (2017), 145, 31-43.
3. Bolf, D., Hadjina, M., Zamarin, A. & Matulja, T. (2021). Methodology for composite materials shrinkage definition for use in shipbuilding and marine technology. *Pomorstvo*, 35 (2), 267-274. <https://doi.org/10.31217/p.35.2.9>
4. John, S., & Vijay, K., Mechanical Characterization of Fiber Reinforced Polymer Composites in Marine Environment: A Review. *Polymer Composites*, (2019), 40(5), 1654-1666.
5. Sebaey, T. A., Experimental Investigation into Quasi-Static Crushing of CFRP Composite Cylindrical Tubes after Thermal Aging, Proceedings of the 10th World Congress on Mechanical, Chemical, and Material Engineering (MCM'21), (2021).
6. Liu, Y., Environmental Effects on Composite Materials: A Comprehensive Review. *Composites Part B: Engineering*,
7. Cao, S.; Zhis, W.; Wang, X. Tensile properties of CFRP and hybrid FRP composites at elevated temperatures. *J. Compos. Mater.* 2009, 49, 315–330.
8. Feng, P.; Wang, J.; Tian, Y.; Loughery, D.; Wang, Y. Mechanical behavior and design of FRP structural members at high and low service temperatures. *J. Compos. Constr.* 2016, 20, 04016021.
9. Mahdi, E.; Hamouda, A.M.S.; Sebaey, T.A. The effect of fiber orientation on the energy absorption capability of axially crushed composite tubes. *Mater. Des.* 2014, 56, 923–928.
10. Palanivelu, S.; Van Paepegem, W.; Degrieck, J.; Vantomme, J.; Kakogiannis, D.; Van Ackeren, J.; Van Hemelrijck, D.; Wastiels, J. Crushing and energy absorption performance of different geometrical shapes of small-scale glass/polyester composite tubes under quasi-static loading conditions. *Compos. Struct.* 2011, 93, 992–1007.
11. Chiu, L.N.S.; Falzon, B.G.; Ruan, D.; Xu, S.; Thomson, R.S.; Chen, B.; Yan, W. Crush responses of composite cylinder under quasi-static and dynamic loading. *Compos. Struct.* 2015, 131, 90–98.
12. Sebaey, T.A.; Mahdi, E. Crushing behaviour of a unit cell of CFRP lattice core for sandwich structures application. *Thin Walled Struct.* 2017, 116, 91–95.
13. Rubino F, Nisticò A, Tucci F, Carlone P. Marine Application of Fiber Reinforced Composites: A Review. *Journal of Marine Science and Engineering*. 2020; 8(1):26. <https://doi.org/10.3390/jmse8010026>
14. Goran Vizentin, Goran Vukelic, Marine environment induced failure of FRP composites used in maritime transport, *Engineering Failure Analysis*, Volume 137 ,2022, 106258, ISSN 1350-6307, <https://doi.org/10.1016/j.engfailanal.2022.106258>.
15. <https://www.easycomposites.eu/200g-plain-weave-3k-carbon-fibre-cloth>
16. <https://www.easycomposites.eu/xc110-210g-22-twill-3k-prepreg-carbon-fibre>
17. <https://meteo.hr/index.php>
18. Manik, P., Tuswan, T., Overstiano Rahardjo, F.A. & Misbahudin, S. (2023). Mechanical Properties Evaluation of Laminated Composites of Petung Bamboo (*Dendrocalamus asper*) and Coconut Coir Fiber as Ship Construction Components. *Pomorstvo*, 37 (1), 75-85. <https://doi.org/10.31217/p.37.1.7>
19. Mahdi, E.; Sebaey, T.A. Crushing Behavior of Hybrid Hexagonal/Octagonal Cellular Composite System: Aramid/carbon hybrid composite. *Mater. Des.* 2014, 63, 6–13.
20. Hussein, R.D.; Ruan, D.; Lu, G.; Sbarski, I. Axial crushing behaviour of honeycomb-filled square carbon fibre reinforced plastic (CFRP) tubes. *Compos. Struct.* 2016, 144, 166–179.
21. Wang, Y.; Feng, J.; Wu, J.; Hu, D. Effects of fiber orientation and wall thickness on energy absorption characteristics of carbon-reinforced composite tubes under different loading conditions. *Compos. Struct.* 2016, 153, 356–368.